

JOB NAME:

DATE:

TYPE:

COMMENTS:

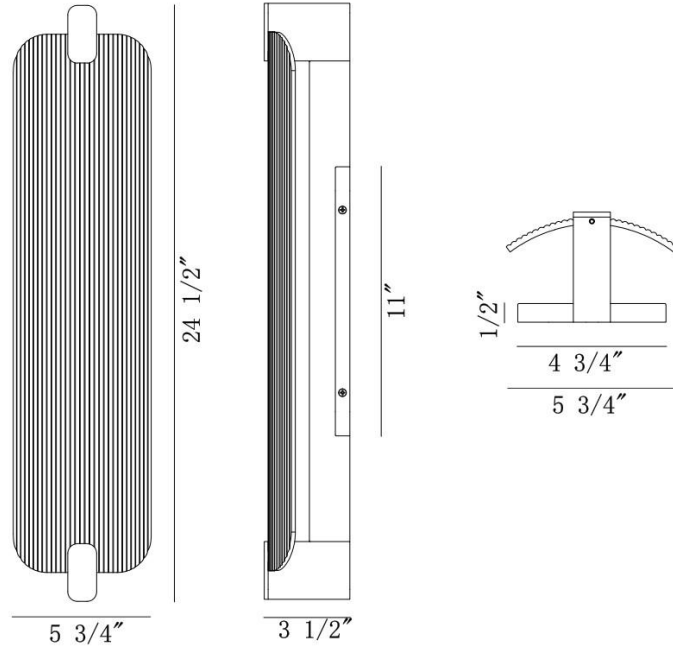

LIGHT INFORMATION

Light Type	Integrated LED
CRI	90
Delivered Lumens	469
Color Temperature	3000K
LED Lifespan (L70)	52000
Number of Lights	1
Light Direction	Multi
Dimming Method	Triac/Elv
Current Type	DC
Input Voltage	120-277
Total Wattage	18

DIMENSIONS & WEIGHT

Width (In)	24.5
Height (In)	5.75
Ext (In)	3.5
Weight (Lbs)	5.07

INSTALLATION

Mounting Type	J-Box
Rating	Dry
Hanging Support Type	J-Box

PRODUCT FINISH

Weathered Brass

SHADE FINISH

Smoked Glass

CERTIFICATIONS & COMPLIANCE

