

H Inline Female Connector

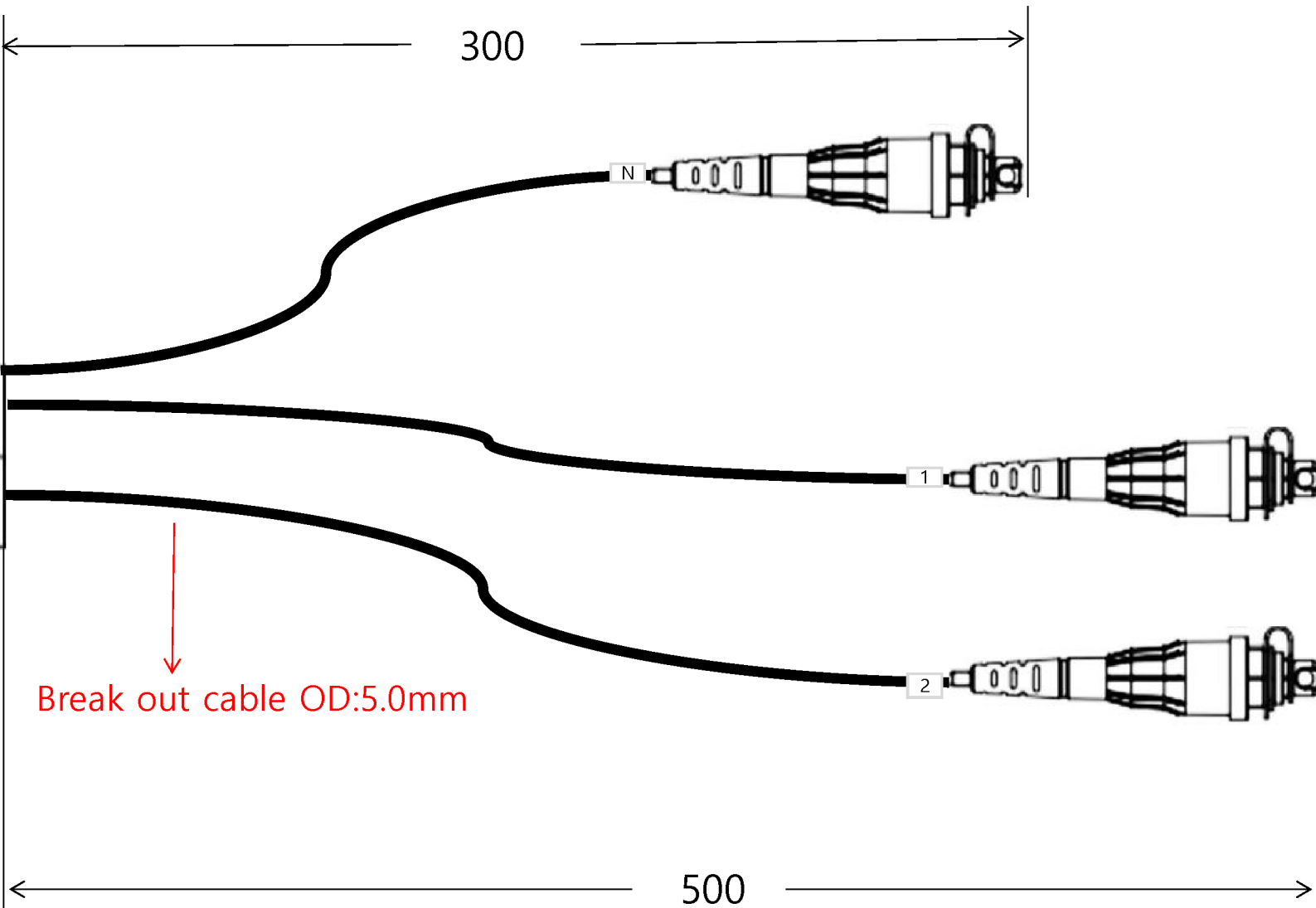

Parameters	1×2	1×4	1×8	1×16
Operating Wavelength (nm)	1260 ~ 1650			
Fiber Type	G657A1			
Insertion Loss (dB) (P/S Grade)	3.8/4.0	7.1/7.3	10.2/10.5	13.5/13.7
Loss Uniformity (dB)	0.4	0.6	0.8	1.2
Polarization Dependent Loss(dB)	0.2	0.2	0.2	0.25
Return Loss (dB) (P/S Grade)	55/50	55/50	55/50	55/50
Directivity (dB)	55	55	55	55
Wavelength Dependent Loss (dB)	0.3	0.3	0.3	0.5
Temperature Stability (-40 ~ 85 °C)(dB)	0.4	0.4	0.4	0.5
Operating Temperature (°C)	-40 ~ 85			
Storage Temperature (°C)	-40 ~ 85			

Hyperdrop Squid-1*2	
IP Grade	IP67
Cable In	0.3m(or Customized)
Cable Out	0.5m(or Customized)

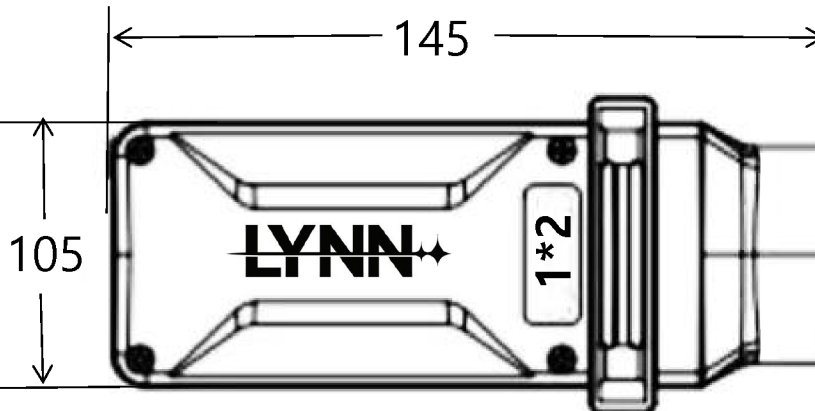