

5

4

3

2

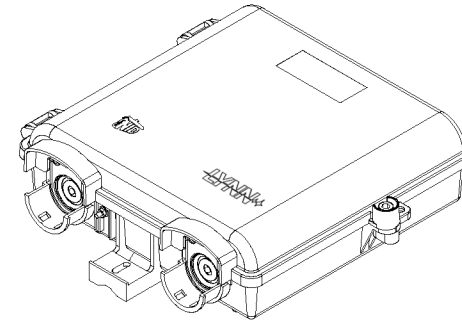
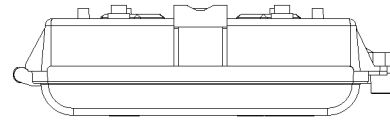

1

REV.	ECN	DESCRIPTION	SIGN	DATE
A0				

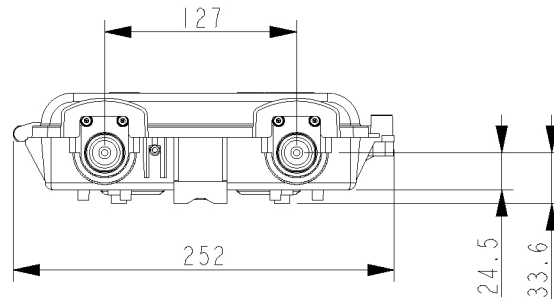
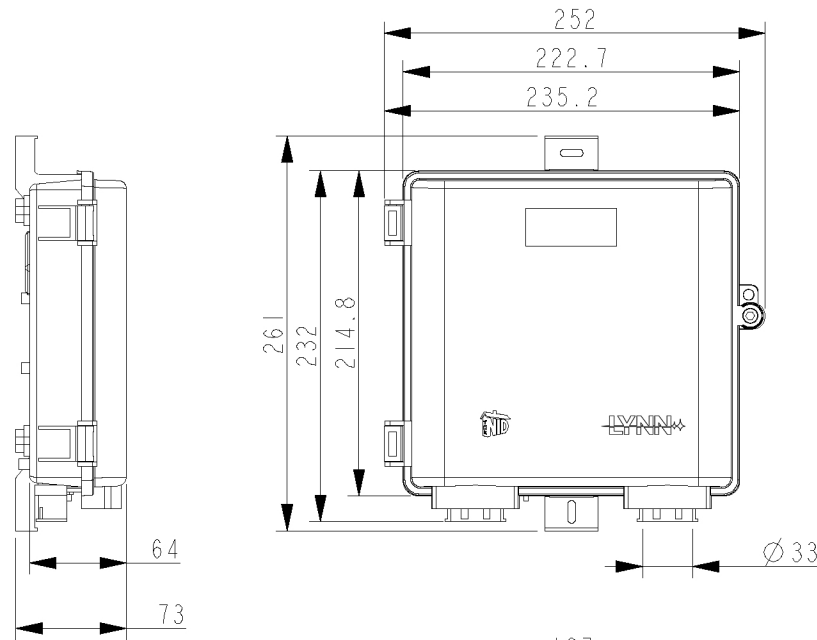
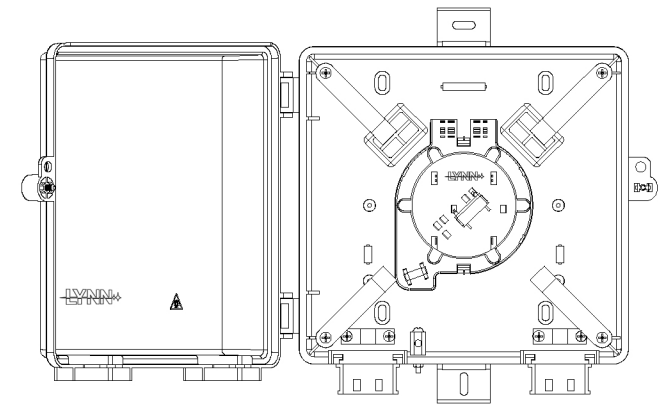

1:5



2		FPP-TN-20000	PC+ABS	1	
1		FPP-TN-A-86-10000	PC+ABS+AL	1	
NO.	NAME	DESCRIPTION	MATERIAL	QTY	NOTE
DRAW	A/R	1:5	PRODUCTS NO.	FPP-TN-A-86	
UNIT	mm	CHK	PRODUCTS NAME		
REV.	A0	APR	PART NO.	FPP-TN-A-86	
DATE	2020-07-20	MAT'L PC+ABS	 		
FIG NO.: FPP-TN-A-86-00000					

5

4

3

2

1