

Project _____

Type _____ Date _____

Address _____

Company _____

EF40 Series



Color Options

FEATURES

Designed using a mix of functionality and style, these 4000-watt heaters use quartz heating elements and include 6-inch wall/ceiling brackets. The heating range for the Eurofase 39-inch 4000-Watt Dual Element heater is approximately 8 feet x 10 feet (80 sq. ft.).

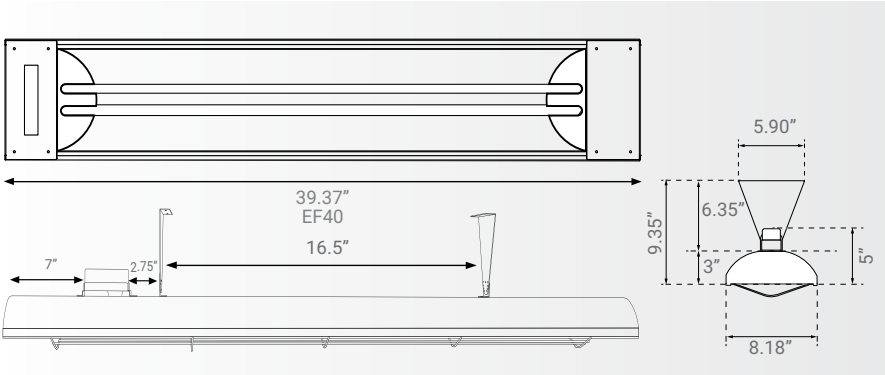

HEAT COVERAGE AREA: 8'x10' (80 sq.ft.)

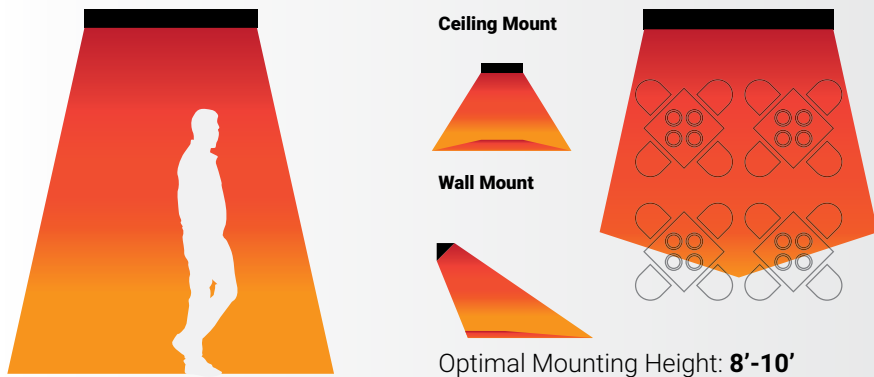

SPECIFICATIONS

WATTAGE	4000 Watts
FAMILY/ SERIES	EF40
VOLTAGE RATING	208V, 240V, 277V, 480V
TOTAL AMPS	19.2A**, 16.7A, 14.4A, 8.33A**
FINISH	Black, Stainless Steel, White, Custom
CONSTRUCTION	Stainless Steel (304 SS)
HEATING AREA (Approximate)	8'x10' (80 sq.ft.)
COMPATIBLE ELEMENTS	EF20208E, EF20240E, EF20277E, EF20480E
MOUNTING OPTIONS	Wall/ Ceiling/ Flush*/ Pole
MOUNTING ANGLE (Wall/Ceiling)	30°/45°
MOUNTING ANGLE (Pole)	0°/15°/30°/45°/60°
LENGTH	39.37"
HEIGHT	8.18"
DEPTH (With 6.36" Brackets)	9.36" (6.36"+3")
WEIGHT	10.5 LBS
INFRARED HEAT TECHNOLOGY	Medium Wave
IPX RATING	IPX4
WARRANTY	3 years

Actual output wattage ranging 90% to 105% of the rated output wattage.

* The Eurofase Heating décor plate is NOT compatible with this flush mount installation.

** Load calculation may change on a 3-phase system feed.

SPECIFICATION GUIDE

WATTAGE	CODE	VOLTAGE	CODE	FINISH	CODE	DÉCOR PLATE*	DÉCOR PLATE CODE
4000W	EF40	208V	208	STAINLESS STEEL	S	CHEVRON	1
		240V	240	BLACK	B	CLOVER	2
		277V	277	WHITE	W	MASON	3
		480V	480	CUSTOM	CS (RAL#)	ASTRA	4
						BRIX	5
						STELLA	6
						ADMIRAL	8

ORDERING GUIDE EXAMPLE:

4000W + 277V + STAINLESS STEEL FINISH = EF40 + 277 + S = EF40277S

ORDERING GUIDE EXAMPLE:

4000W + 277V + STAINLESS STEEL FINISH + DÉCOR PLATE CHEVRON = EF40 + 277 + S+1 = EF40277S1