

<b>PROGRAM:</b>	SOLIDWORKS
<b>UPDATED:</b>	11/19/2024
<b>SALES REV:</b>	A
<b>SIZE:</b>	A (8.5x11) (IN)

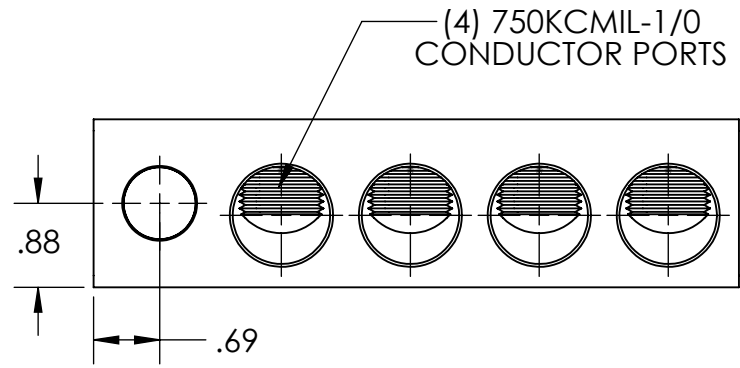
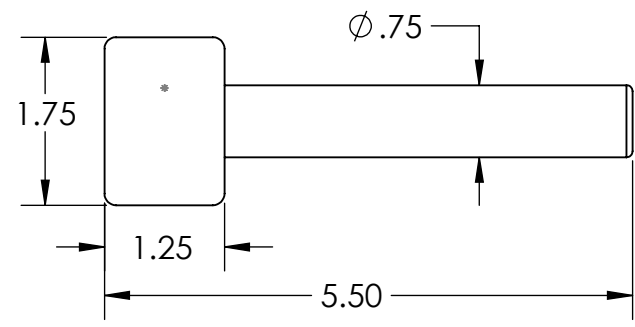
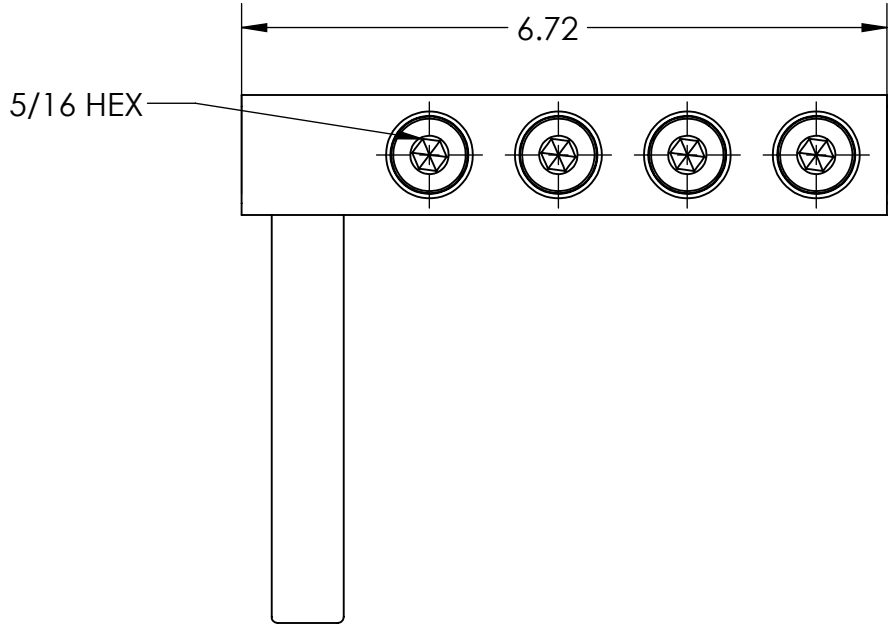
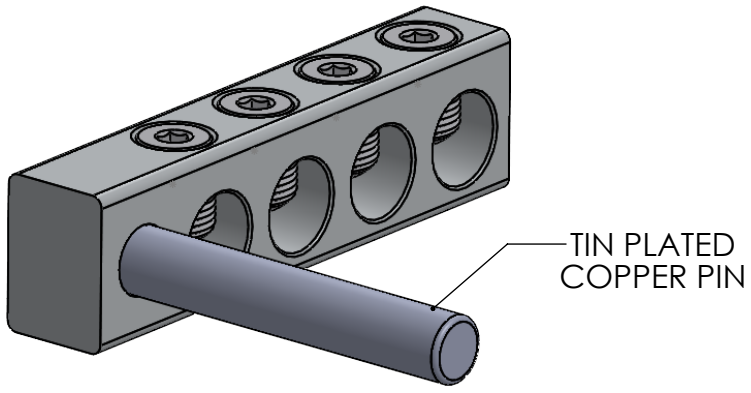

**FEATURES:**

1. Material: Aluminum.
2. Class B/C compressed, concentric, and compact conductor only.
3. Dual rated AL-CU.