

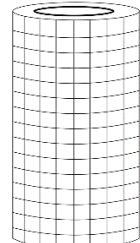



Dog Fence Post/Fence Installation Instructions

Note: These instructions are **UNIVERSAL**. They are to aid in the installation of all styles of fence mesh and heights. If a tension system was purchased, please refer to the tensioning kit instructions **BEFORE** these instructions.

| HARDWARE PARTS | | | |
|---|---|--|---|
| <p style="text-align: center;">A</p> <p style="text-align: center;">QTY: 7 per 100 ft</p>  <p style="text-align: center;">17 Gauge 1 5/8" Black Powder Coated Galvanized Pipe (Refer to packing slip for SKU #)</p> | <p style="text-align: center;">B</p> <p style="text-align: center;">QTY: 1 roll per 100 ft</p>  <p style="text-align: center;">Fencing Mesh (Refer to packing slip for SKU #)</p> | <p style="text-align: center;">C</p> <p style="text-align: center;">QTY: 7 per 100 ft</p>  <p style="text-align: center;">Black Ground Sleeve for 1 5/8" Post SKU: DE8195</p> | <p style="text-align: center;">D</p> <p style="text-align: center;">QTY: 1 per 21 Posts</p>  <p style="text-align: center;">Drive Cap for 1 5/8" Post Sleeve SKU: DE2812</p> |
| <p style="text-align: center;">E</p> <p style="text-align: center;">QTY: 7 per 100 ft</p>  <p style="text-align: center;">1 5/8" Black Vinyl Post Cap SKU: DE8089</p> | <p style="text-align: center;">F</p> <p style="text-align: center;">QTY: 1 pk per 100 ft</p>  <p style="text-align: center;">8" High Strength Nylon Self-Locking Ties – 100pk SKU: DE2854</p> | <p style="text-align: center;">G</p> <p style="text-align: center;">QTY: 1</p>  <p style="text-align: center;">Cutter Puller Tool for Self-Locking Ties SKU: DE2864</p> | <p style="text-align: center;">H</p> <p style="text-align: center;">QTY: 1 pk per 100 ft</p>  <p style="text-align: center;">Ground Stakes (Refer to packing slip for SKU #)</p> |
| <p style="text-align: center;">I</p> <p style="text-align: center;">QTY: 7 per 100 ft</p>  <p style="text-align: center;">Self-Tapping Screw 3/4" SKU: DE9978-1</p> | <p style="text-align: center;">If you selected an Anti-Dig Ground Flare:</p> <p style="text-align: center;">J</p>  <p style="text-align: center;">QTY: 1 roll per 100 ft 2' x 100' Steel Hex Web Black PVC Coated Fence SKU: SH20210011B</p> | <p style="text-align: center;">K</p> <p style="text-align: center;">QTY: 1</p>  <p style="text-align: center;">Magnetic Level</p> | <p style="text-align: center;">Recommended Tools (Not Included):</p> <ul style="list-style-type: none"> Power Drill with 5/16" Drill Bit Tape Measure Sledgehammer Hammer Earth Auger Digging Bar (For rocky/hard ground) String Line |

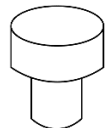
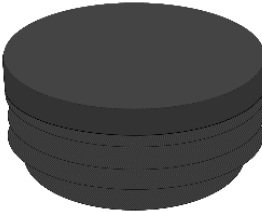
Dog Fence Post/Fence Installation Instructions

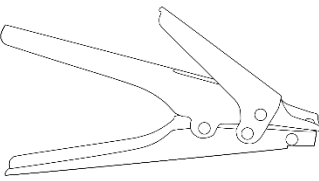
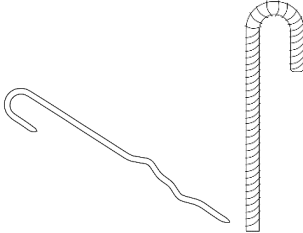
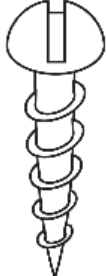
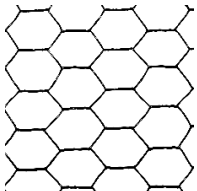
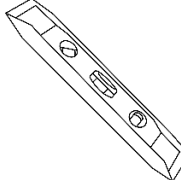
1. Lay out the fence design and place all end/corner posts. If you did not purchase corners/ends for your system, place posts where the ends/corners would be. Pull a string between the corners to determine the fence line for post placement. Place **GROUND SLEEVES (C)** 8'-10' apart depending on your overall fence length.

Note: It is very important to determine the location of all posts before driving the sleeves into the ground. Posts will need to be placed at all changes in direction and steep changes in grade. On hard ground it may be necessary to use an **EARTH AUGER (Sold Separately; SKU: DE8189)** or **DIGGING BAR** to make a hole before driving the ground sleeves in. **Kits without corners, ends, or gates, will have to space posts evenly.**

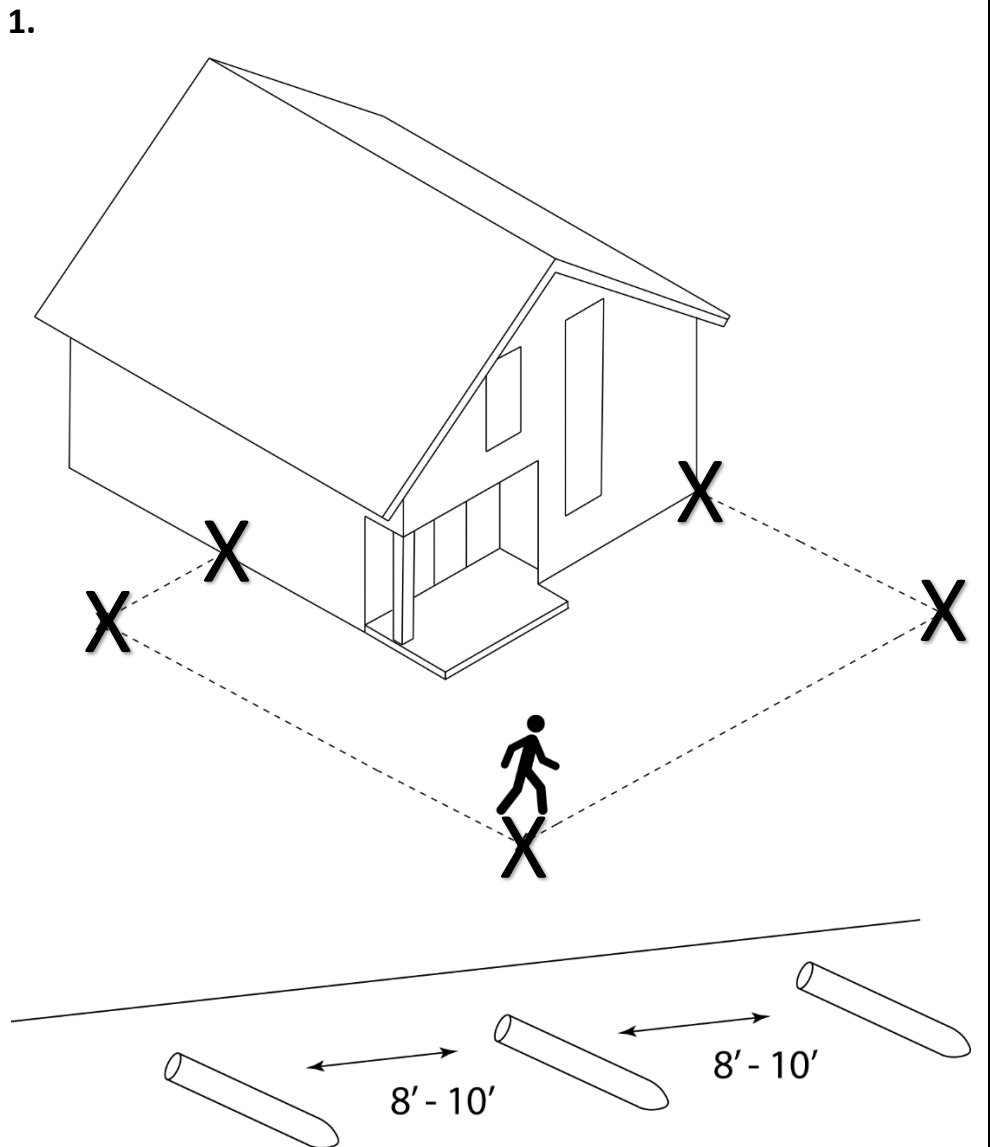

2. Using the provided **DRIVE CAP (D)** and a sledgehammer, drive the **GROUND SLEEVES (C)** into the ground, leaving $\frac{1}{2}$ " above ground to keep out debris and allow for securing the post. Use the **MAGNETIC LEVEL (K)** to ensure the sleeve is as straight as possible.

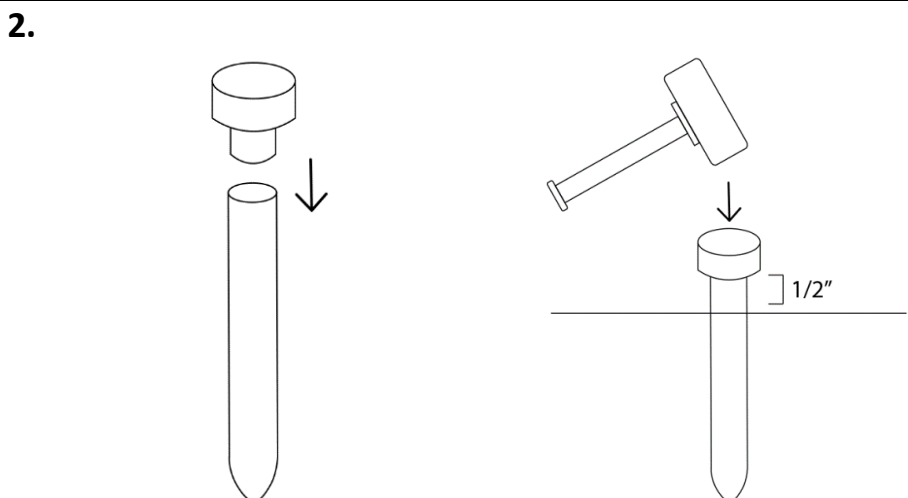

3. Insert the **DOME CAPS (E)** on the top of each **POST (A)** before sliding into the **GROUND SLEEVES (C)**. Lock posts into place by screwing through the sleeve and into the post using a **SELF-TAPPING SCREW (I)**.

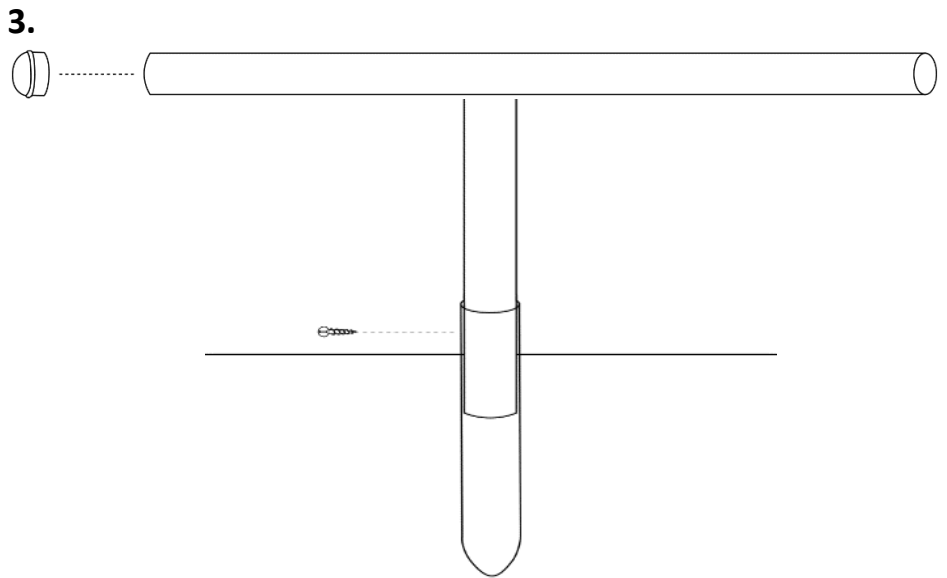

4. Starting on the **OUTSIDE** of your fence line at your first **POST (A)**, attach your **FENCE MESH (B)** to the **POST (A)** using a **SELF-LOCKING TIE (F)** and the **CUTTER PULLER TOOL (G)**. You'll want to use a **SELF-LOCKING TIE (F)** every 12" along the height of your **POST (A)**.

Note: For significant grade changes, you will need to cut the fence at the nearest **POST (A)** and panel out the **FENCE MESH (B)** along the grade of the slope.

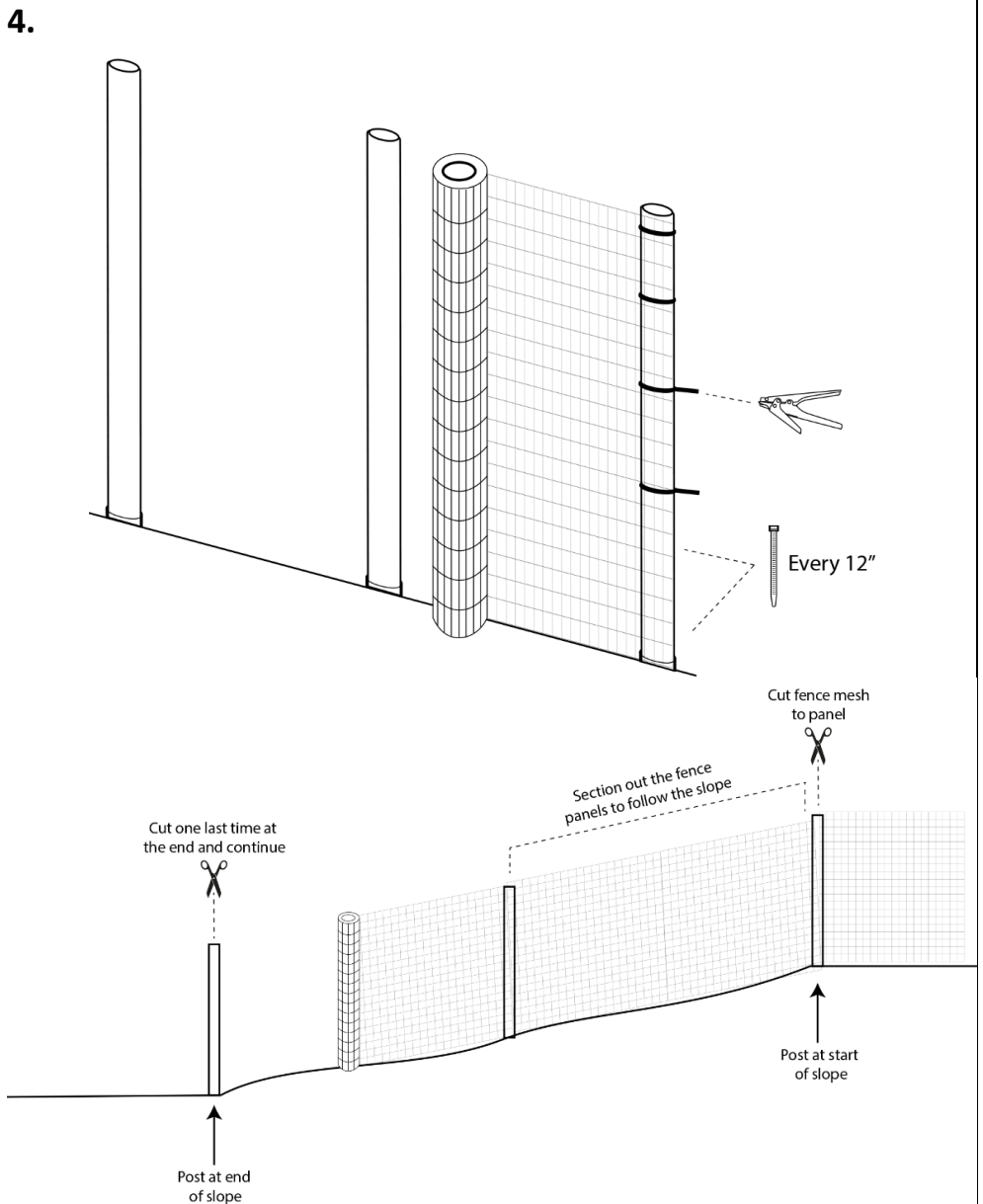

5. As you unroll the **FENCE MESH (B)**, repeat **STEP 4** as you go along the perimeter of the fence line until all sides are enclosed.

Note: For starting a new roll of fence, terminate the old roll at the nearest line post and start your new roll at the same post. Fencing will also terminate at end posts and gates.

5.

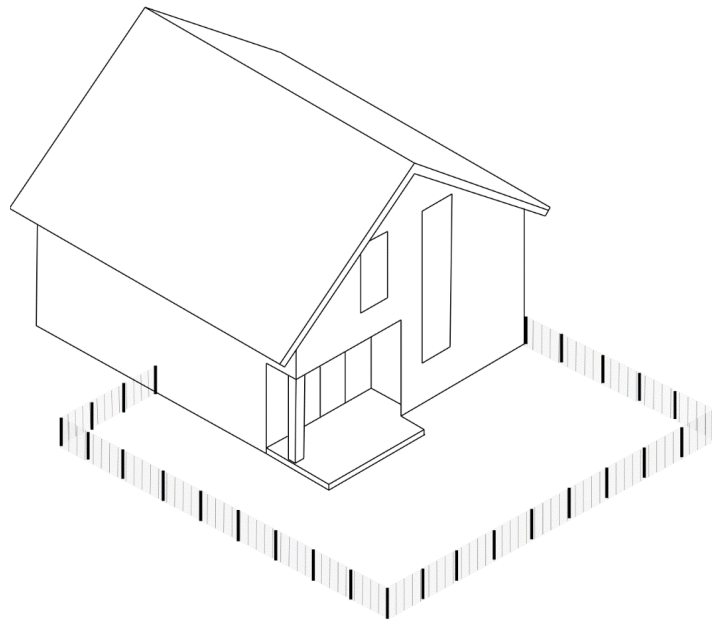

Optional: Anti-Dig Barrier Instructions (Skip Step if Not Applicable)

1. Unroll the **ANTI-DIG BARRIER (J)** overlapping the existing fence. You will want to allow approximately 1' of overlap on your fencing. Attach the **ANTI-DIG BARRIER (J)** to the **FENCE MESH (A)** on the **INSIDE** of the fence line using a **SELF-LOCKING ZIP TIE (G)** every 1'. The remaining 1' of the **ANTI-DIG BARRIER (J)** can either be flared at the bottom and tacked down using the **GROUND STAKES (H)** or trenched down into the ground to further prevent digging.

Note: There will be a gap where the barrier goes around the fence posts, this is normal. Depending on fence length, you may need to purchase extra **SELF-LOCKING TIES (G)** to complete the Anti-Dig Barrier.

1.

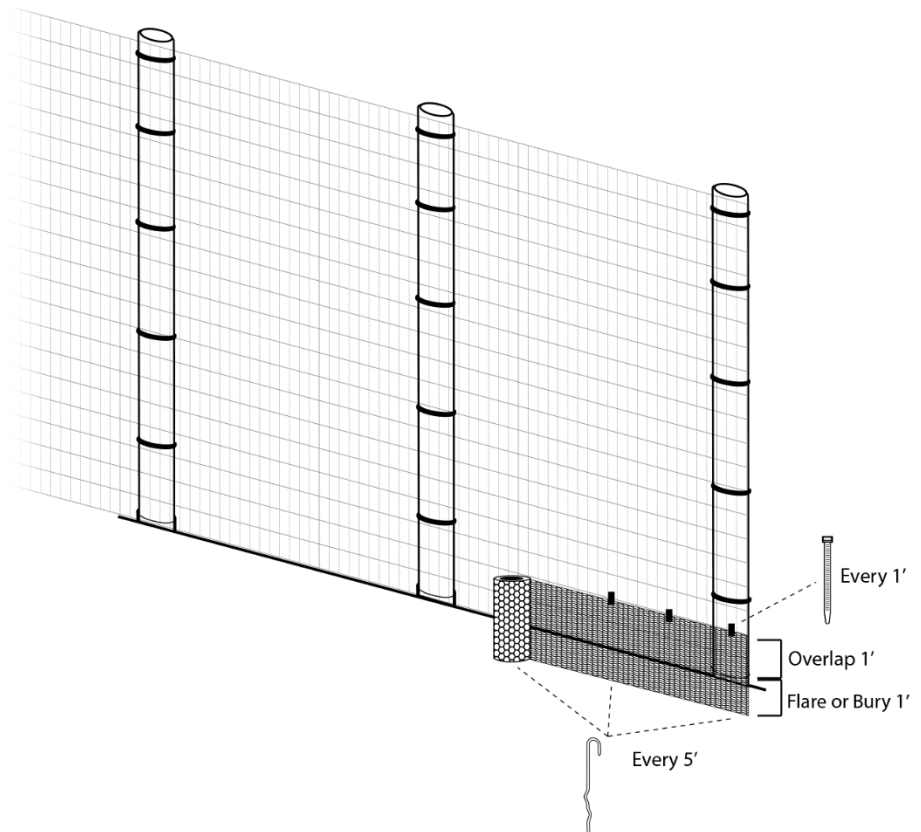

6. After completing the fence line, tack down the bottom portion of the fence every 5' using the **GROUND STAKES (H)**.

6.

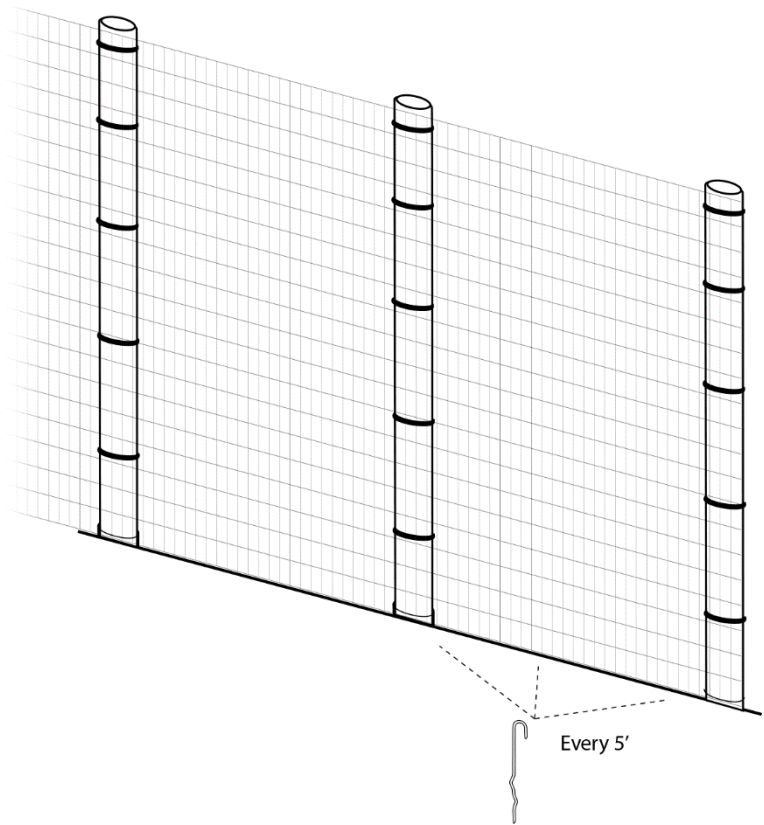

Important Notes:

Remember to install all line posts and gate posts before starting to set up the fence.

When unrolling the fence, tie it to the posts before making any cuts to ensure that the fence is well attached. During installation, take care to not overstretch any of the fence mesh. You want to ensure that the fence is taut but not stretched out.