

# METALLICS

## 2022 CATALOG

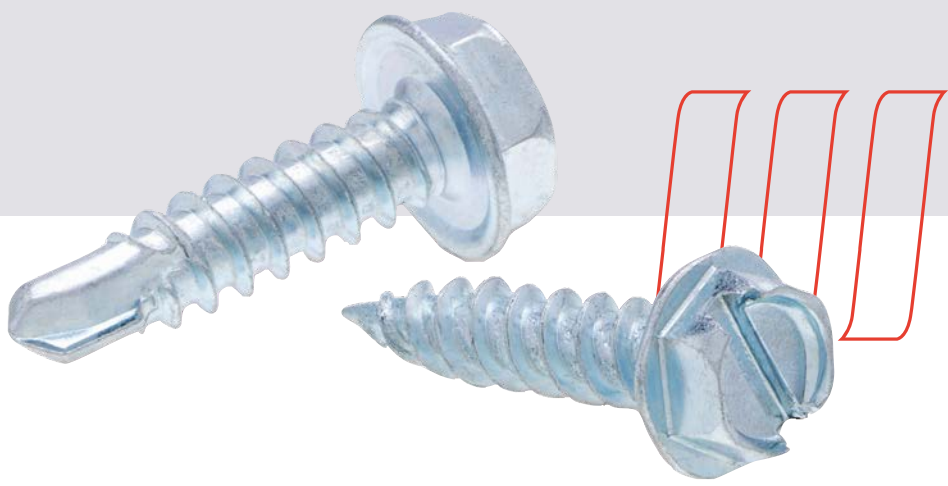

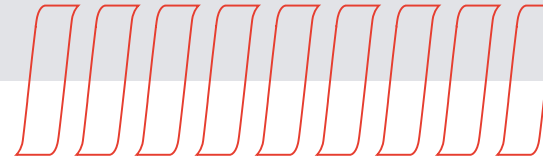

## The Metallics Difference

Metallics is an American company that has served tradesmen since 1959. We built our foundation on quality, service and innovation. When you partner with Metallics, you can count on forming a strong relationship not only with us, but also with the customers you serve.

Our knowledgeable sales and support staff located in our Bristol, Connecticut Headquarters are always available to answer your questions. You can find us on the web at [metallics.us](http://metallics.us). Please call us to learn more about the Metallics Difference at (800) 243-8272 or email us at [sales@metallics.us](mailto:sales@metallics.us).

## Markets Served

- Electrical
- Plumbing & HVAC
- Solar
- Wind Power
- Food & Beverage
- Healthcare
- Hospitality & Entertainment
- Industrial Manufacturing
- Residential & Commercial Construction
- Municipality
- Government & Military
- Panel Building
- Prefabrication

# METALLICS

## AMERICA'S SOURCE FOR PREMIER AND INNOVATIVE FASTENERS

### Fastener Reference Guide

#### Measuring Threaded Fasteners (length)

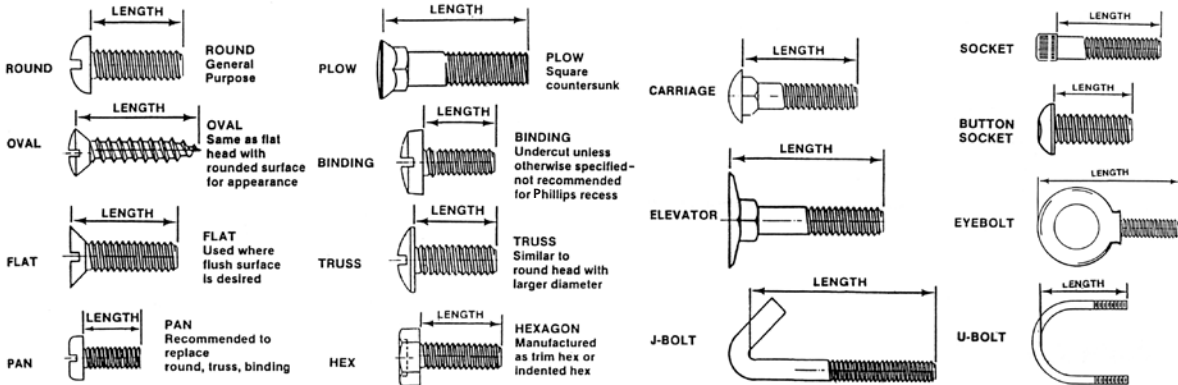

#### Fastener Identifier (D=Diameter)

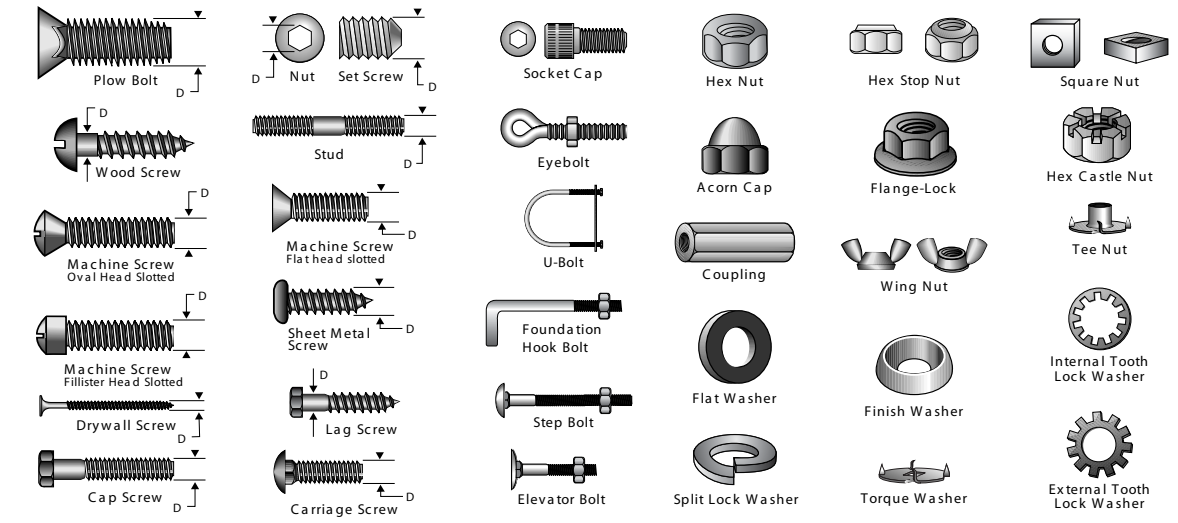

#### Head Styles

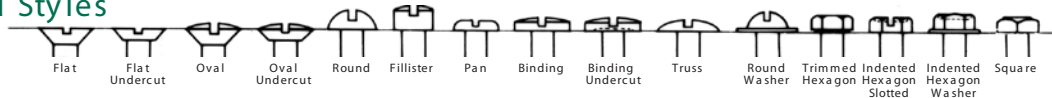

#### Measuring Threads

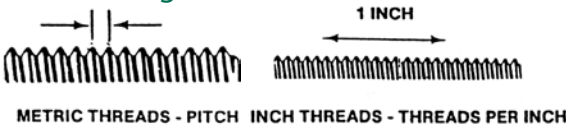

#### Head Markings of Fasteners

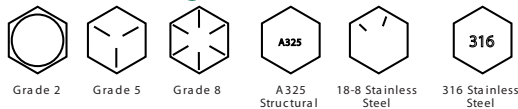

#### Driver Styles

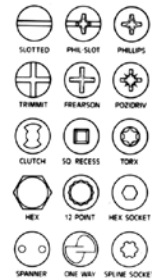

#### To Select Phillips Driver Style

SCREW TYPE	SCREW DIAMETER & HEAD STYLE			BIT or DRIVER SIZE
	OVAL, PAN & FLAT	ROUND & FILLISTER	TRUSS & BRAZIER	
Machine & Tapping Screws	0 & 1	0 & 1	0 & 1	0
	2 thru 4	2 thru 4	2 thru 5	1
	5 thru 10	5 thru 10	6 thru 10	2
	12 thru 1/4	12 thru 5/16	12 thru 1/4	3
	5/16 thru 1/2	3/8 thru 1/2	5/16 thru 1/2	4
Wood Screws	0 & 1	0 & 1	0 & 1	0
	2 thru 4	2 thru 4	2 thru 5	1
	5 thru 9	5 thru 10	6 thru 10	2
	10 thru 16	11 thru 16	12 thru 16	3
	18 thru 24	18 thru 24	18 thru 24	4

#990030

<b>A</b>	<b>SCREWS .....</b>	<b>4-69</b>
<b>B</b>	<b>NUTS .....</b>	<b>70-79</b>
<b>C</b>	<b>WASHERS.....</b>	<b>80-92</b>
<b>D</b>	<b>BOLTS.....</b>	<b>93-125</b>
<b>E</b>	<b>ANCHORING DEVICES .....</b>	<b>126-166</b>
<b>F</b>	<b>FIXTURE HANGING ACCESSORIES.....</b>	<b>167-181</b>
<b>G</b>	<b>SPECIAL PURPOSE ELECTRICAL FASTENER.....</b>	<b>182-199</b>
<b>H</b>	<b>TOOLS, DRILLS AND ACCESSORIES.....</b>	<b>200-224</b>

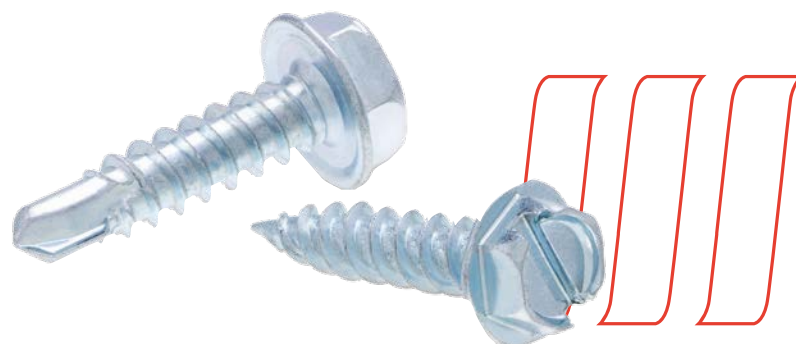





**AN INDUSTRY FIRST!**  
A free square drive bit with each jar of  
Tri-Drive Machine Screws



**ROUND HEAD TRI-DRIVE  
MACHINE SCREWS**  
STEEL ZINC



Introduced nationally by Metallics in 1994

- Slotted
- Phillips
- Square Drive

Three drives  
in one head!

PART#	UPC#	DIAMETER	LENGTH	WT. PER PKG.	STD. PKG. UM
JTRM80	80003	6-32	1/2	.28	100/500
JTRM81	80004	6-32	3/4	.36	100/500
JTRM63	80005	6-32	1	.43	100/500
JTRM82	80006	6-32	1 1/2	.58	100/500
JTRM83	80007	6-32	2	.73	100/500
JTRM15	78615	8-32	3/8	.34	100/500
JTRM84	80008	8-32	1/2	.45	100/500
JTRM85	80009	8-32	3/4	.51	100/500
JTRM86	80010	8-32	1	.65	100/500
JTRM87	80011	8-32	1 1/4	.75	100/500
JTRM88	80012	8-32	1 1/2	.86	100/500
JTRM89	80013	8-32	2	1.07	100/500
JTRM16	81255	10-32	1/4	.49	100/500
JTRM20	78620	10-32	3/8	.48	100/500
JTRM33	80014	10-32	1/2	.57	100/500
JTRM92	78692	10-32	3/4	.70	100/500
JTRM98	80015	10-32	1	.89	100/500
JTRM69	78669	10-32	1 1/4	.95	100/500
JTRM75	78675	10-32	1 1/2	1.12	100/500
JTRM113	78611	10-32	2	1.39	100/500
JTRM22	80016	1/4 -20	3/8	.95	100/500
JTRM99	80017	1/4 -20	1/2	1.10	100/500
JTRM100	80018	1/4 -20	3/4	1.33	100/500
JTRM101	80019	1/4 -20	1	1.58	100/500
JTRM102	80020	1/4 -20	1 1/4	1.77	100/500
JTRM103	80021	1/4 -20	1 1/2	2.08	100/500
JTRM104	80022	1/4 -20	2	2.62	100

ALSO AVAILABLE--TRI-DRIVE™ SHEET METAL SCREWS

OTHER SIZES AND QUANTITIES AVAILABLE BY REQUEST

- Slotted
- Phillips
- Square Drive

Three drives  
in one head!

**1000 PACK ROUND HEAD  
TRI-DRIVE MACHINE SCREW +KITS**  
STEEL ZINC



Introduced Nationally by Metallics in 1994!

Drive bit included in each pack.



PART#	UPC#	DIAMETER	LENGTH	WT. PER PKG.	STD. PKG. UM
TRM80M	27780	6-32	1/2	2.30	1000
TRM81M	27781	6-32	3/4	3.10	1000
TRM63M	27763	6-32	1	3.80	1000
TRM82M	27782	6-32	1 1/2	5.80	1000
TRM83M	27783	6-32	2	6.80	1000
TRM15M	27715	8-32	3/8	3.40	1000
TRM84M	27784	8-32	1/2	3.51	1000

OTHER SIZES AND QUANTITIES AVAILABLE BY REQUEST

CONTINUED ON NEXT PAGE  
[www.metallics.us](http://www.metallics.us)

-  Slotted
  -  Phillips
  -  Square Drive
- Three drives in one head!



CONTINUED  
**1000 PACK ROUND HEAD  
 TRI-DRIVE MACHINE SCREW KITS**  
 STEEL ZINC

**Introduced Nationally by Metallics in 1994!**  
 Drive bit included in each pack.



PART#	UPC#	DIAMETER	LENGTH	WT. PER PKG.	STD. PKG. UM
TRM85M	27785	8-32	3/4	4.80	1000
TRM86M	27786	8-32	1	6.00	1000
TRM87M	27787	8-32	1 1/4	7.00	1000
TRM88M	27788	8-32	1 1/2	8.10	1000
TRM89M	27789	8-32	2	10.30	1000
TRM16M	27716	10-32	1/4	4.90	1000
TRM20M	27720	10-32	3/8	5.02	1000
TRM33M	27733	10-32	1/2	5.70	1000
TRM92M	27792	10-32	3/4	7.00	1000
TRM98M	27798	10-32	1	8.90	1000
TRM69M	27769	10-32	1 1/4	9.50	1000
TRM75M	27775	10-32	1 1/2	11.20	1000
TRM113M	27813	10-32	2	13.90	1000
TRM22M	27722	1/4-20	3/8	9.50	1000
TRM99M	27799	1/4-20	1/2	11.00	1000
TRM100M	27800	1/4-20	3/4	13.30	1000
TRM101M	27801	1/4-20	1	15.80	1000
TRM102M	27802	1/4-20	1 1/4	17.70	1000
TRM103M	27803	1/4-20	1 1/2	10.80	1000
TRM104M	27804	1/4-20	2	25.60	1000

OTHER SIZES AND QUANTITIES AVAILABLE BY REQUEST



-  Slotted
-  Phillips

**ROUND HEAD SLOTTED/PHILLIPS/  
 COMBO MACHINE SCREWS**

STEEL ZINC

In 1985, Metallics was the first fastener company in America to offer a full line of Combo's!

PART#	UPC#	DIAMETER	LENGTH	WT. PER PKG.	STD. PKG. UM
<b>SLOTTED</b>					
JRM15SLT	28892	4-40	3/8	.16	100/500
JRM30SLT	28894	4-40	1/2	.20	100/500
JRM46SLT	28900	4-40	3/4	.27	100/500
JRM61SLT	28908	4-40	1	.30	100/500
JRM73SLT	28911	4-40	1 1/2	.38	100/500
JRM16SLT	28893	5-40	3/8	.20	100/500
JRM31SLT	28895	5-40	1/2	.25	100/500
JRM47SLT	28903	5-40	3/4	.27	100/500
JRM62SLT	28909	5-40	1	.37	100/500
JRM74SLT	28912	5-40	1 1/2	.39	100/500
JRM3SLT	28899	6-32	1/4	.22	100/500
JRM10SLT	28886	6-32	5/16	.23	100/500
JRM39SLT	28898	6-32	5/8	.33	100/500
JRM81SLT	28795	6-32	3/4	.34	100/500
JRM82SLT	28796	6-32	1 1/2	.56	100/500
JRM107SLT	28887	6-32	3 1/2	1.19	100
JRM144SLT	28891	6-32	4	1.41	100
JRM148SLT	28904	6-32	6	1.96	100
JRM4SLT	28902	8-32	1/4	.31	100/500
JRM11SLT	28888	8-32	5/16	.34	100/500

OTHER SIZES AND QUANTITIES AVAILABLE BY REQUEST \* = Painted Ivory Heads, † = Painted White Heads

CONTINUED ON NEXT PAGE  
[www.metallics.us](http://www.metallics.us)

CONTINUED

ROUND HEAD SLOTTED/PHILLIPS/ COMBO MACHINE SCREWS

STEEL ZINC

In 1985, Metallics was the first fastener company in America to offer a full line of Combo's!



A

PART#	UPC#	DIAMETER	LENGTH	WT. PER PKG.	STD. PKG. UM
<b>SLOTTED</b>					
JRM136SLT	28797	8-32	5/8	.45	100/500
JRM137SLT	28798	8-32	7/8	.57	100/500
JRM87SLT	28799	8-32	1¼	.73	100/500
JRM106SLT	28885	8-32	1¾	.98	100/500
JRM89SLT	28800	8-32	2	1.08	100/500
JRM112SLT	28890	8-32	2¼	1.17	100/500
JRM90SLT	28801	8-32	2½	1.27	100/500
JRM91SLT	28802	8-32	3	1.58	100
JRM108SLT	28864	8-32	3½	1.74	100
JRM23SLT	28804	8-32	4	2.01	100
JRM141SLT	28921	8-32	5	1.30	50
JRM12SLT	28918	10-24	5/16	.47	100/500
JRM41SLT	28948	10-24	5/8	.53	100/500
JRM34SLT	28943	10-24	7/8	.72	100/500
JRM93SLT	28805	10-24	1	.81	100/500
JRM94SLT	28806	10-24	1¼	.95	100/500
JRM95SLT	28807	10-24	1½	1.12	100/500
JRM96SLT	28916	10-24	1¾	1.22	100/500
JRM127SLT	28808	10-24	3	1.97	100
JRM312SLT	28936	10-24	3½	2.29	100
JRM150SLT	28925	10-24	4	2.57	100
JRM152SLT	28927	10-24	5	2.29	100
JRM154SLT	28929	10-24	6	4.09	100
JRM13SLT	28919	10-32	5/16	.47	100/500
JRM42SLT	28949	10-32	5/8	.64	100/500
JRM109SLT	86109	12-24	5/8	.87	100/500
JRM37SLT	81075	12-24	¾	.92	100/500
JRM45SLT	28809	12-24	1	1.12	100/500
JRM124SLT	28794	12-24	1¼	1.42	100/500
JRM52SLT	28810	12-24	1½	1.57	100/500
JRM125SLT	28843	12-24	2	1.99	100/500
JRM138SLT	28844	12-24	3	2.12	100
JRM99SLT	28840	¼-20	½	1.01	100/500
JRM44SLT	80059	¼-20	5/8	1.08	100/500
JRM100SLT	28841	¼-20	¾	1.24	100/500
JRM103SLT	28842	¼-20	1½	2.03	100/500
JRM104SLT	28811	¼-20	2	2.54	100/500
JRM105SLT	28812	¼-20	2½	3.07	100
JRM128SLT	28813	¼-20	3	3.58	100
JRM131SLT	28865	¼-20	3½	4.14	100
JRM132SLT	28815	¼-20	4	4.61	100
JRM133SLT	28816	¼-20	5	11.90	100
JRM134SLT	28817	¼-20	6	6.52	100
JRM35SLT	28896	5/16-18	½	1.88	100/500
JRM50SLT	28901	5/16-18	¾	2.12	100/500
JRM65SLT	28818	5/16-18	1	2.70	100/500
JRM38SLT	28820	5/16-18	1½	3.58	100/500
JRM115SLT	28821	5/16-18	2	4.25	100/500
JRM122SLT	28822	5/16-18	2½	5.15	100
JRM129SLT	10347	5/16-18	3	6.00	100
JRM146SLT	13188	5/16-18	4	7.15	100
JRM147SLT	13189	5/16-18	5	8.12	100

OTHER SIZES AND QUANTITIES AVAILABLE BY REQUEST \* = Painted Ivory Heads, † = Painted White Heads

CONTINUED ON NEXT PAGE

www.metallics.us



CONTINUED

**ROUND HEAD SLOTTED/PHILLIPS/ COMBO MACHINE SCREWS**

STEEL ZINC

In 1985, Metallics was the first fastener company in America to offer a full line of Combo's!



PART#	UPC#	DIAMETER	LENGTH	WT. PER PKG.	STD. PKG. UM
<b>SLOTTED</b>					
JRM36SLT	71058	3/8-16	1/2	3.03	100/500
JRM51SLT	28826	3/8-16	3/4	3.43	100
JRM66SLT	28827	3/8-16	1	4.03	100
JRM72SLT	28828	3/8-16	1 1/4	4.47	100
JRM79SLT	28913	3/8-16	1 3/4	6.50	100
JRM116SLT	28830	3/8-16	2	6.54	100
JRM123SLT	28831	3/8-16	2 1/2	7.54	100
JRM130SLT	28832	3/8-16	3	4.34	50
JRM67SLT	28910	3/8-16	3 1/2	5.12	50
JRM135SLT	28833	3/8-16	4	5.65	50
JRM54SLT	28905	1/2-13	3/4	6.36	100/500
JRM53SLT	28834	1/2-13	1	7.45	100
JRM55SLT	28835	1/2-13	1 1/4	4.08	50
JRM49SLT	28836	1/2-13	1 1/2	9.76	100/500
JRM143SLT	28837	1/2-13	2	12.20	100
<b>COMBO</b>					
JRM139	28845	4-40	2	.52	100/500
JRM17	80023	6-32	3/8	.25	100/500
JRM80	80024	6-32	1/2	.27	100/500
JRM81	80025	6-32	3/4	.34	100/500
JRM63	80026	6-32	1	.42	100/500
JRM68	80027	6-32	1 1/4	.49	100/500
JRM82	80028	6-32	1 1/2	.56	100/500
JRM82I'	87682	6-32	1 1/2	.56	100/500
JRM82W'	87482	6-32	1 1/2	.56	100/500
JRM83	80029	6-32	2	.70	100/500
JRM140	80030	6-32	2 1/2	.86	100/500
JRM142	80031	6-32	3	1.02	100
JRM41	83941	8-32	1/4	.31	100/500
JRM18	80032	8-32	3/8	.34	100/500
JRM84	80033	8-32	1/2	.40	100/500
JRM136	81183	8-32	5/8	.45	100/500
JRM85	80034	8-32	3/4	.51	100/500
JRM86	80035	8-32	1	.60	100/500
JRM86M	90886	8-32	1	5.72	1000
JRM87	80036	8-32	1 1/4	.73	100/500
JRM88	80037	8-32	1 1/2	.83	100/500
JRM89	80038	8-32	2	1.08	100/500
JRM89V	81188	8-32	2	5.33	500
RM89-1M	67894	8-32	2	10.66	1000
RM89-2M	81083	8-32	2	21.32	2000
RM89B	91589	8-32	2	41.19	4000
JRM90	80039	8-32	2 1/2	1.27	100/500
JRM91	80040	8-32	3	1.58	100
JRM23	81085	8-32	4	2.01	100
JRM19	80041	10-24	3/8	.45	100/500
JRM32	80042	10-24	1/2	.52	100/500
JRM32M	78500	10-24	1/2	.52	1000
JRM92	80043	10-24	3/4	.67	100/500
JRM93	80044	10-24	1	.81	100/500
JRM94	80045	10-24	1 1/4	.95	100/500
JRM95	80046	10-24	1 1/2	1.12	100/500

OTHER SIZES AND QUANTITIES AVAILABLE BY REQUEST 'I' = Painted Ivory Heads, 'W' = Painted White Heads

CONTINUED



**ROUND HEAD SLOTTED/PHILLIPS/ COMBO MACHINE SCREWS**

STEEL ZINC

In 1985, Metallics was the first fastener company in America to offer a full line of Combo's!



A

PART#	UPC#	DIAMETER	LENGTH	WT. PER PKG.	STD. PKG. UM
<b>COMBO</b>					
JRM96	80047	10-24	2	1.39	100/500
JRM97	80048	10-24	2½	1.65	100
JRM127	80049	10-24	3	1.97	100
JRM20	80050	10-32	3/8	.48	100/500
JRM20M	90820	10-32	3/8	4.46	1000
JRM33	80051	10-32	½	.55	100/500
JRM48	80052	10-32	¾	.70	100/500
JRM48M	90848	10-32	¾	6.79	1000
JRM98	80053	10-32	1	.86	100/500
JRM69	80054	10-32	1¼	.99	100/500
JRM75	80055	10-32	1½	1.14	100/500
JRM113	80056	10-32	2	1.47	100/500
JRM114	86114	10-32	2½	1.79	100
JRM190	86190	10-32	3	2.13	100
JRM120	81180	10-32	3½	2.43	100
JRM121	81181	10-32	4	2.81	100
JRM109	86109	12-24	5/8	.87	100
JRM22	80057	¼-20	3/8	.90	100/500
JRM99	80058	¼-20	½	1.00	100/500
JRM100	80060	¼-20	¾	1.25	100/500
JRM101	80061	¼-20	1	1.54	100/500
JRM102	80062	¼-20	1¼	1.78	100/500
JRM103	80063	¼-20	1½	2.00	100/500
JRM110	86110	¼-20	1¾	2.35	100
JRM104	80064	¼-20	2	2.52	100
JRM105	81105	¼-20	2½	3.06	100
JRM128	81110	¼-20	3	3.58	100
JRM132	81115	¼-20	4	4.61	100
JRM133	81116	¼-20	5	5.95	100
JRM134	81119	¼-20	6	6.77	100
JRM65	81103	5/16-18	1	2.70	100
JRM71	83971	5/16-18	1¼	3.11	100/500
JRM36	80065	3/8-16	½	2.91	100/500
JRM51	80066	3/8-16	¾	3.43	100
JRM66	80067	3/8-16	1	4.03	100
JRM72	80068	3/8-16	1¼	4.47	100
JRM78	80069	3/8-16	1½	5.00	100
JRM116	80070	3/8-16	2	6.48	100
JRM123	80071	3/8-16	2½	7.54	100
JRM130	80072	3/8-16	3	4.34	50
JRM135	81120	3/8-16	4	5.65	50
RM137	10132	3/8-16	6	16.05	100

OTHER SIZES AND QUANTITIES AVAILABLE BY REQUEST ' = Painted Ivory Heads, ' = Painted White Heads



Slotted

## ROUND HEAD SLOTTED MACHINE SCREWS

18-8 STAINLESS • 316 STAINLESS

PART#	UPC#	DIAMETER	LENGTH	WT. PER PKG.	STD. PKG. UM
<b>18-8 STAINLESS</b>					
JSRM34	83734	4-40	¼	.19	100/500
JSRM03	85092	4-40	1	.37	100/500
JSRM86	83786	6-32	¼	.21	100/500
JSRM50	80073	6-32	¾	.24	100/500
JSRM10	80074	6-32	½	.29	100/500
JSRM51	80075	6-32	¾	.38	100/500
JSRM11	80076	6-32	1	.44	100/500
JSRM12	80077	6-32	1¼	.51	100/500
JSRM13	80078	6-32	1½	.58	100/500
JSRM141	85141	6-32	1¾	.65	100/500
JSRM14	80079	6-32	2	.72	100/500
JSRM60	80080	8-32	¾	.35	100/500
JSRM15	80081	8-32	½	.41	100/500
JSRM61	80082	8-32	⅝	.43	100/500
JSRM16	80083	8-32	¾	.54	100/500
JSRM17	80084	8-32	1	.64	100/500
JSRM18	80085	8-32	1¼	.70	100/500
JSRM19	80086	8-32	1½	.84	100/500
JSRM05	92930	8-32	1¾	.96	100/500
JSRM20	80087	8-32	2	1.08	100/500
JSRM21	80088	10-24	½	.53	100/500
JSRM71	80089	10-24	⅝	.59	100/500
JSRM22	80090	10-24	¾	.70	100/500
JSRM23	80091	10-24	1	.84	100/500
JSRM24	80092	10-24	1¼	1.00	100/500
JSRM144	85144	10-24	1½	1.13	100/500
JSRM74	80093	10-24	1¾	1.27	100/500
JSRM146	85146	10-24	2	1.43	100/500
JSRM04	89104	10-24	4	1.36	50
JSRM154	85099	10-24	6	2.65	50
JSRM80	83780	10-32	¼	.42	100/500
JSRM25	80094	10-32	½	.57	100/500
JSRM26	80095	10-32	¾	.74	100/500
JSRM27	80096	10-32	1	.87	100/500
JSRM28	80097	10-32	1¼	1.02	100/500
JSRM33	83733	10-32	1½	1.18	100/500
JSRM147	85147	10-32	1¾	1.32	100/500
JSRM148	85148	10-32	2	1.46	100/500
JSRM101	85101	12-24	½	.75	100/500
JSRM29	80098	¼-20	¾	.67	100/500
JSRM30	80099	¼-20	½	1.01	100/500
JSRM35	83735	¼-20	⅝	1.17	100/500
JSRM31	80100	¼-20	¾	1.29	100/500
JSRM32	80101	¼-20	1	1.51	100/500
JSRM85	80102	¼-20	1¼	1.80	100/500
JSRM90	80103	¼-20	1½	2.07	100/500
JSRM95	83795	¼-20	2	2.60	100/500
JSRM97	83797	¼-20	2½	2.83	100
JSRM100	85100	¼-20	3	3.70	100
JSRM132	89232	¼-20	4	2.38	50
JSRM136	12020	¼-20	6	6.86	100
JSRM722	71522	⅝-18	1¼	3.13	100/500
JSRM133	85133	¾-16	½	2.86	100/500
JSRM66	83766	¾-16	1	4.22	100/500
JSRM131	85131	¾-16	1¼	4.73	100/500
JSRM134	85134	¾-16	1½	5.20	100/500
JSRM130	81957	¾-16	3	5.19	50
JSRM135	85135	¾-16	4	5.84	50/250

OTHER SIZES AND QUANTITIES AVAILABLE BY REQUEST

CONTINUED ON NEXT PAGE  
www.metallics.us



CONTINUED

**ROUND HEAD SLOTTED MACHINE SCREWS**

18-8 STAINLESS • 316 STAINLESS



Slotted

A

PART#	UPC#	DIAMETER	LENGTH	WT. PER PKG.	STD. PKG. UM
<b>18-8 STAINLESS</b>					
JSRM40	81958	½-13	1	.44	50
JSRM41	81959	½-13	1¼	.49	50
JSRM42	81960	½-13	1½	.52	50
JSRM43	81961	½-13	2	.68	50
JSRM44	81962	½-13	3	.82	50
JSRM45	81963	½-13	4	1.04	50
<b>316 STAINLESS</b>					
JSRM261	85159	10-32	¾	.70	100/500
JSRM1461	85200	10-32	2	1.49	100/500
JSRM311	85160	¼-20	¾	.74	100/500
JSRM721	85161	5/16-18	¾	.76	100/500

OTHER SIZES AND QUANTITIES AVAILABLE BY REQUEST



Phillips

**ROUND HEAD PHILLIPS MACHINE SCREWS**

18-8 STAINLESS

PART#	UPC#	DIAMETER	LENGTH	WT. PER PKG.	STD. PKG. UM
JSRM10P	14647	6-32	½	.30	100/500
JSRM11P	93511	6-32	1	.44	100/500
JSRM13P	93513	6-32	1½	1.27	100/500
JSRM14P	93514	6-32	2	.72	100/500
JSRM15P	93515	8-32	½	.42	100/500
JSRM16P	93516	8-32	¾	.53	100/500
JSRM17P	93517	8-32	1	.64	100/500
JSRM19P	93519	8-32	1½	.86	100/500
JSRM20P	93520	8-32	2	1.03	100/500
JSRM36P	93536	8-32	2½	1.21	100
JSRM21P	93521	10-24	½	.55	100/500
JSRM22P	93522	10-24	¾	.70	100/500
JSRM23P	93523	10-24	1	.84	100/500
JSRM24P	93524	10-24	1¼	.99	100/500
JSRM74P	93574	10-24	1¾	1.32	100/500
JSRM146	85146	10-24	2	1.43	100/500
JSRM82P	93582	10-24	3	2.21	100/500
JSRM25P	93525	10-32	½	.57	100/500
JSRM26P	93526	10-32	¾	.75	100/500
JSRM27P	93527	10-32	1	.89	100/500
JSRM33P	93533	10-32	1½	1.19	100/500
JSRM148P	93648	10-32	2	1.53	100/500
JSRM190P	85194	10-32	3	2.21	100
JSRM100P	93600	12-24	¾	.92	100/500
JSRM101P	93601	12-24	1	1.13	100/500
JSRM102P	93602	12-24	1½	1.51	100/500
JSRM29P	93529	¼-20	3/8	.67	100/500
JSRM30P	93530	¼-20	½	1.02	100/500
JSRM31P	93531	¼-20	¾	1.31	100/500
JSRM32P	93532	¼-20	1	1.62	100/500
JSRM85P	93585	¼-20	1¼	1.78	100/500
JSRM90P	93590	¼-20	1½	2.03	100/500
JSRM95P	93595	¼-20	2	2.55	100/500
JSRM97P	93597	¼-20	2½	3.08	100/500
JSRM132P	93632	¼-20	4	4.74	100
JSRM137P	93637	3/8-16	¾	3.66	100/500
JSRM138P	93638	3/8-16	1	4.22	100/500
JSRM139P	93639	3/8-16	1½	5.39	100
JSRM140P	93640	3/8-16	2	6.49	100

OTHER SIZES AND QUANTITIES AVAILABLE BY REQUEST



Slotted

## ROUND HEAD SLOTTED MACHINE SCREWS

BRASS

PART#	UPC#	DIAMETER	LENGTH	WT. PER PKG.	STD. PKG. UM
JRMB69	83469	4-40	¾	.27	100
JRMB75	83475	4-40	1	.31	100/500
JRMB6	83406	6-32	¾	.27	100/500
JRMB61	80104	6-32	½	.29	100/500
JRMB62	80105	6-32	¾	.37	100/500
JRMB63	80106	6-32	1	.45	100/500
JRMB64	83464	6-32	1¼	.53	100/500
JRMB65	83465	6-32	1½	.59	100/500
JRMB66	83466	6-32	2	.79	100/500
JRMB140	83540	6-32	2½	.89	100/500
JRMB77	83477	6-32	3	1.47	100/500
JRMB8	83408	8-32	¾	.34	100/500
JRMB83	80107	8-32	½	.43	100/500
JRMB85	80108	8-32	¾	.54	100/500
JRMB86	80109	8-32	1	.61	100/500
JRMB87	83487	8-32	1¼	.80	100/500
JRMB88	83488	8-32	1½	.88	100/500
JRMB91	80110	8-32	2	1.16	100/500
JRMB90	83490	8-32	2½	1.33	100/500
JRMB78	83478	8-32	.3	1.65	100/500
JRMB7	83407	10-24	¾	.45	100/500
JRMB49	83449	10-24	½	.58	100/500
JRMB92	83450	10-24	¾	.79	100/500
JRMB93	83493	10-24	1	.84	100/500
JRMB94	83494	10-24	1¼	.99	100/500
JRMB96	83495	10-24	2	1.46	100/500
JRMB1	83401	10-24	2½	1.37	100/500
JRMB103	83403	10-32	¼	.41	100/500
JRMB95	80111	10-32	½	.57	100/500
JRMB48	80112	10-32	¾	.73	100/500
JRMB98	80113	10-32	1	.91	100/500
JRMB73	83473	10-32	1½	1.35	100/500
JRMB113	83537	10-32	2	1.46	100/500
JRMB105	83529	10-32	2½	1.80	100/500
JRMB76	83476	12-24	½	.75	100/500
JRMB79	83479	12-24	¾	.77	100/500
JRMB80	83480	12-24	1	1.15	100/500
JRMB22	83422	¼-20	¾	.90	100/500
JRMB99	83499	¼-20	½	1.00	100/500
JRMB100	83524	¼-20	¾	1.32	100/500
JRMB30	86268	¼-20	1	1.59	100/500
JRMB102	83526	¼-20	1¼	1.78	100/500
JRMB15	83404	¼-20	1½	1.93	100/500
JRMB104	83528	¼-20	2	2.52	100/500
JRMB108	40170	¼-20	3	3.84	100/500
JRMB2	83402	¼-28	½	1.03	100/500

OTHER SIZES AND QUANTITIES AVAILABLE BY REQUEST





Slotted



Phillips

Two drives  
in one head!



## STOVE BOLTS

STEEL ZINC

Standard Package Square Plastic Jar

Round Head "Combo" (Slotted and Phillips) Machine Screws with Hex Nuts

PART#	UPC#	DIAMETER	LENGTH	WT. PER PKG.	STD. PKG. UM
RSB63	10488	6-32	1	.88	100/500
RSB85	84285	8-32	1/2	.66	100/500
RSB86	10491	8-32	1	.99	100/500
RSB89	10492	8-32	2	1.30	100/500
RSB90	10493	8-32	2 1/2	1.56	100/500
RSB91	84291	8-32	3	1.83	100/500
RSB94	10173	8-32	4	2.23	100/500
RSB92	10466	10-24	3/4	.97	100/500
RSB93	10158	10-24	1	1.14	100/500
RSB95	10467	10-24	1 1/2	1.31	100/500
RSB16	10340	10-32	1/2	.86	100/500
RSB17	10341	10-32	3/4	.98	100/500
RSB18	10342	10-32	1	1.13	100/500
RSB19	10343	10-32	1 1/4	1.28	100/500
RSB20	10344	10-32	1 1/2	1.42	100/500
RSB21	10345	10-32	2	1.72	100
RSB22	10159	1/4-20	3/8	1.58	100/500
RSB99	10160	1/4-20	1/2	1.67	100/500
RSB100	10161	1/4-20	3/4	1.96	100/500
RSB105	13037	1/4-20	2 1/2	3.98	100
RSB106	13045	1/4-20	3	4.30	100
RSB66	10157	3/8-16	1	5.67	100
RSB72	10489	3/8-16	1 1/4	6.64	100
RSB78	10490	3/8-16	1 1/2	7.68	100
RSB116	13038	3/8-16	2	9.60	100
RSB101	10162	1/4-20	1	2.22	100/500
RSB102	10163	1/4-20	1 1/4	2.42	100/500
RSB103	10164	1/4-20	1 1/2	2.68	100
RSB104	10165	1/4-20	2	3.22	100

OTHER SIZES AND QUANTITIES AVAILABLE BY REQUEST



Slotted



## STOVE BOLTS

18-8 STAINLESS

PART#	UPC#	DIAMETER	LENGTH	WT. PER PKG.	STD. PKG. UM
RSB100S	98800	1/4-20	3/4	2.07	100/500
RSB101S	98801	1/4-20	1	2.37	100/500
RSB103S	98803	1/4-20	1 1/2	2.79	100
RSB104S	98804	1/4-20	2	3.31	100
RSB72SS	84589	3/8-16	1 1/4	6.75	100

OTHER SIZES AND QUANTITIES AVAILABLE BY REQUEST



Slotted



## PAN HEAD SLOTTED MACHINE SCREWS

18-8 STAINLESS

PART#	UPC#	DIAMETER	LENGTH	WT. PER PKG.	STD. PKG. UM
<b>18-8 STAINLESS</b>					
JSPM344SS	84534	4-40	3/8	.14	100/500
JSPM30SS	84530	4-40	7/16	.19	100/500
JSPM6SS	84506	6-32	1/4	.21	100/500
JSPM50SS	84550	6-32	3/8	.24	100/500

OTHER SIZES AND QUANTITIES AVAILABLE BY REQUEST

CONTINUED ON NEXT PAGE

[www.metallics.us](http://www.metallics.us)



CONTINUED  
**PAN HEAD SLOTTED MACHINE SCREWS**  
 18-8 STAINLESS



PART#	UPC#	DIAMETER	LENGTH	WT. PER PKG.	STD. PKG. UM
<b>18-8 STAINLESS</b>					
JSPM8SS	84508	6-32	1/2	.29	100/500
JSPM9SS	84509	6-32	3/4	.35	100/500
JSPM10SS	84510	6-32	1	.43	100/500
JSPM11SS	84511	6-32	1 1/4	.51	100/500
JSPM12SS	84512	8-32	3/8	.36	100/500
JSPM13SS	84513	8-32	1/2	.44	100/500
JSPM14SS	84514	8-32	3/4	.52	100/500
JSPM15SS	84515	8-32	1	.63	100/500
JSPM16SS	84516	10-24	1/2	.55	100/500
JSPM17SS	84517	10-24	3/4	.70	100/500
JSPM18SS	84518	10-24	1	.83	100/500
JSPM19SS	84519	10-32	1/2	.59	100/500
JSPM20SS	84520	10-32	1	.89	100/500
JSPM28SS	84528	10-32	1 1/4	.96	100/500
JSPM102SS	92281	12-24	3/4	.95	100/500
JSPM103SS	92282	12-24	1	1.13	100/500
JSPM104SS	92283	12-24	1 1/4	1.33	100/500
JSPM115SS	92294	1/4-20	1 1/2	2.13	100/500

OTHER SIZES AND QUANTITIES AVAILABLE BY REQUEST



**PAN HEAD PHILLIPS/COMBO MACHINE SCREWS**  
 STEEL ZINC • BLACK OXIDE

PART#	UPC#	DIAMETER	LENGTH	WT. PER PKG.	STD. PKG. UM
<b>PHILLIPS</b>					
JPMP66	86310	4-40	1/4	.16	100/500
JPMP118	85992	4-40	1/2	.20	100/500
JPMP119	85993	4-40	1	.40	100/500
JPMP120	85994	4-40	2	.73	100/500
JPMP78	86312	6-32	1/4	.23	100/500
JPMP23	86253	6-32	3/8	.34	100/500
JPMP80	86261	6-32	1/2	.30	100/500
JPMP24	86254	6-32	5/8	.34	100/500
JPMP81	86262	6-32	3/4	.34	100/500
JPMP63	86263	6-32	1	.44	100/500
JPMP82	86265	6-32	1 1/4	.49	100/500
JPMP113	82296	6-32	1 1/2	.56	100/500
JPMP13	86278	6-32	2	.70	100/500
JPMP21	86293	6-32	2 1/2	.84	100
JPMP4	86255	8-32	1/4	.34	100/500
JPMP90	86276	8-32	3/8	.38	100/500
JPMP84	86270	8-32	1/2	.43	100/500
JPMP43	86326	8-32	5/8	.50	100/500
JPMP85	86271	8-32	3/4	.55	100/500
JPMP86	86272	8-32	1	.66	100/500
JPMP87	86273	8-32	1 1/4	.73	100/500
JPMP88	86266	8-32	1 1/2	.83	100/500
JPMP89	86275	8-32	2	1.08	100/500
JPMP22	86297	8-32	2 1/2	1.33	100
JPMP39	86259	10-24	1/2	.58	100/500
JPMP37	86308	10-24	3/4	.65	100/500
JPMP40	86319	10-24	1	.81	100/500

OTHER SIZES AND QUANTITIES AVAILABLE BY REQUEST

CONTINUED

**PAN HEAD PHILLIPS/COMBO  
MACHINE SCREWS**  
STEEL ZINC • BLACK OXIDE



Phillips

A

PART#	UPC#	DIAMETER	LENGTH	WT. PER PKG.	STD. PKG. UM
<b>PHILLIPS</b>					
JPMP42	86325	10-24	1¼	.95	100/500
JPMP41	86323	10-24	1½	1.14	100/500
JPMP6	86257	10-32	¼	.47	100/500
JPMP20	86288	10-32	¾	.56	100/500
JPMP33	72033	10-32	½	.61	100/500
JPMP36	86307	10-32	¾	.68	100/500
JPMP1032	86234	10-32	1	.95	100/500
JPMP69	86292	10-32	1¼	1.05	100/500
JPMP75	86294	10-32	1½	1.27	100/500
JPMP76	86295	10-32	1¾	1.38	100/500
JPMP114	86322	10-32	2	1.75	100/500
JPMP5	85977	12-24	½	.77	100
JPMP38	86269	12-24	¾	1.00	100
JPMP99	86298	¼-20	½	1.15	100/500
JPMP100	86299	¼-20	¾	1.45	100/500
JPMP101	86300	¼-20	1	1.62	100/500
JPMP102	86301	¼-20	1¼	1.92	100/500
JPMP103	86302	¼-20	1½	2.09	100/500
JPMP104	86303	¼-20	2	2.67	100/500
JPMP128	86305	¼-20	3	3.58	100
<b>BLACK OXIDE</b>					
JPMP1032BLK	86330	10-32	1	.95	100/500

OTHER SIZES AND QUANTITIES AVAILABLE BY REQUEST



Phillips

**PAN HEAD PHILLIPS MACHINE SCREWS**  
18-8 STAINLESS

PART#	UPC#	DIAMETER	LENGTH	WT. PER PKG.	STD. PKG. UM
<b>18-8 STAINLESS</b>					
JSPMP144SS	98744	4-40	¼	.16	100/500
JSPMP141SS	98930	4-40	1	.30	100/500
JSPMP78SS	98978	6-32	¼	.22	100/500
JSPMP17SS	98917	6-32	¾	.26	100/500
JSPMP80SS	98980	6-32	½	.30	100/500
JSPMP15SS	98915	8-32	½	.44	100/500
JSPMP16SS	98916	8-32	¾	.63	100/500
JSPMP18SS	98918	8-32	1	.65	100/500
JSPMP1SS	98901	8-32	1½	.86	100/500
JSPMP20SS	98920	8-32	2	1.11	100/500
JSPMP22SS	98922	8-32	2½	1.27	100
JSPMP21SS	98921	10-24	½	.61	100/500
JSPMP2SS	98902	10-24	¾	.74	100/500
JSPMP7SS	98907	10-24	1	.90	100/500
JSPMP4SS	98904	10-24	1¼	1.04	100/500
JSPMP5SS	98905	10-24	1½	1.15	100/500
JSPMP30SS	98930	10-32	¾	.54	100/500
JSPMP33SS	98933	10-32	½	.59	100/500
JSPMP33SSV	79333	10-32	½	.59	500
JSPMP3SS	98903	10-32	¾	.73	100/500

OTHER SIZES AND QUANTITIES AVAILABLE BY REQUEST

CONTINUED ON NEXT PAGE  
www.metallics.us

CONTINUED

## PAN HEAD PHILLIPS MACHINE SCREWS

18-8 STAINLESS



Phillips



PART#	UPC#	DIAMETER	LENGTH	WT. PER PKG.	STD. PKG. UM
<b>18-8 STAINLESS</b>					
JSPMP23SS	98923	10-32	7/8	.77	100/500
JSPMP35SS	98935	10-32	1	1.02	100/500
JSPMP36SS	98936	10-32	1½	1.14	100/500
JSPMP37SS	98937	10-32	2	1.60	100/500
JSPMP38SS	98938	10-32	2½	1.90	100
JSPMP122434SS	99122	12-24	¾	1.00	100/500
JSPMP29SS	98929	¼-20	¾	1.01	100/500
JSPMP99SS	98699	¼-20	½	.80	100/500
JSPMP44SS	98644	¼-20	5/8	1.17	100/500
JSPMP100SS	98700	¼-20	¾	1.31	100/500
JSPMP102SS	98702	¼-20	1¼	1.78	100/500
JSPMP116SS	96116	¼-20	2½	3.20	100
JSPMP132SS	99132	¼-20	4	4.61	100

OTHER SIZES AND QUANTITIES AVAILABLE BY REQUEST

## PAN HEAD PHILLIPS METRIC MACHINE SCREWS

STEEL ZINC • 18-8 STAINLESS



Phillips



PART#	UPC#	DIAMETER	LENGTH	WT. PER PKG.	STD. PKG. UM
<b>STEEL ZINC</b>					
JMPMP36	79788	M3	6	.20	100
JMPMP38	79790	M3	8	.22	100
JMPMP310	79792	M3	10	.24	100
JMPMP46	79789	M4	6	.36	100
JMPMP48	79822	M4	8	.39	100
JMPMP410	79824	M4	10	.41	100
JMPMP412	79826	M4	12	.44	100
JMPMP414	62917	M4	14	.47	100
JMPMP420	79834	M4	20	.53	100
JMPMP430	79844	M4	30	.58	100
JMPMP58	62921	M5	8	.66	100
JMPMP510	79854	M5	10	.71	100
JMPMP512	79856	M5	12	.82	100
JMPMP516	79860	M5	16	.86	100
JMPMP520	79864	M5	20	.96	100
JMPMP610	79926	M6	10	1.07	100
JMPMP612	62923	M6	12	1.17	100
JMPMP616	62927	M6	16	1.25	100
JMPMP620	62931	M6	20	1.46	100
JMPMP630	79938	M6	30	1.88	100
JMPMP635	79939	M6	35	2.03	100
JMPMP640	79940	M6	40	2.27	100
JMPMP812	79905	M8	12	2.45	100
JMPMP860	79936	M8	60	14.44	100
<b>18-8 STAINLESS</b>					
JMPMP258SS	62913	M2.5	8	.15	100
JMPMP38SS	62915	M3	8	.21	100
JMPMP46SS	79820	M4	6	.35	100

OTHER SIZES AND QUANTITIES AVAILABLE BY REQUEST

CONTINUED ON NEXT PAGE

www.metallics.us

CONTINUED

PAN HEAD PHILLIPS METRIC MACHINE SCREWS

STEEL ZINC • 18-8 STAINLESS



PART#	UPC#	DIAMETER	LENGTH	WT. PER PKG.	STD. PKG. UM
<b>18-8 STAINLESS</b>					
JMPMP465SS	79820	M4	65	35.30	100
JMPMP510SS	62919	M5	10	.69	100
JMPMP516SS	79916	M5	16	.86	100
JMPMP665SS	79843	M6	65	3.90	100
JMPMP830SS	79934	M8	30	.91	100

OTHER SIZES AND QUANTITIES AVAILABLE BY REQUEST



FLAT HEAD SLOTTED MACHINE SCREWS

STEEL ZINC

PART#	UPC#	DIAMETER	LENGTH	WT. PER PKG.	STD. PKG. UM
JFM15	92019	4-40	<sup>3</sup> / <sub>8</sub>	.12	100/500
JFM30	83830	4-40	<sup>1</sup> / <sub>2</sub>	.18	100/500
JFM46	83846	4-40	<sup>3</sup> / <sub>4</sub>	.23	100/500
JFM61	92027	4-40	1	.25	100/500
JFM73	92029	4-40	<sup>1</sup> / <sub>2</sub>	.27	100/500
JFM31	92020	5-40	<sup>1</sup> / <sub>2</sub>	.21	100/500
JFM38	92021	5-40	<sup>5</sup> / <sub>8</sub>	.23	100/500
JFM47	83847	5-40	<sup>3</sup> / <sub>4</sub>	.23	100/500
JFM62	83862	5-40	1	.33	100/500
JFM74	43128	5-40	<sup>1</sup> / <sub>2</sub>	.35	100/500
JFM3	83803	6-32	<sup>1</sup> / <sub>4</sub>	.18	100/500
JFM10	92009	6-32	<sup>5</sup> / <sub>16</sub>	.21	100/500
JFM17	83817	6-32	<sup>3</sup> / <sub>8</sub>	.21	100/500
JFM80	80114	6-32	<sup>1</sup> / <sub>2</sub>	.24	100/500
JFM39	83839	6-32	<sup>5</sup> / <sub>8</sub>	.28	100/500
JFM81	80115	6-32	<sup>3</sup> / <sub>4</sub>	.30	100/500
JFM63	80116	6-32	1	.39	100/500
JFM68	80117	6-32	<sup>1</sup> / <sub>4</sub>	.46	100/500
JFM82	80118	6-32	<sup>1</sup> / <sub>2</sub>	.53	100/500
JFM79	83879	6-32	<sup>1</sup> / <sub>3</sub>	.62	100/500
JFM83	80119	6-32	2	.62	100/500
JFM140	80120	6-32	<sup>2</sup> / <sub>2</sub>	.82	100/500
JFM142	80121	6-32	3	.97	100/500
JFM142W*	92265	6-32	3	1.05	100/500
JFM144	81916	6-32	4	1.28	100/500
JFM4	92022	8-32	<sup>1</sup> / <sub>4</sub>	.20	100/500
JFM11	92011	8-32	<sup>5</sup> / <sub>16</sub>	.22	100/500
JFM18	83818	8-32	<sup>3</sup> / <sub>8</sub>	.27	100/500
JFM84	80122	8-32	<sup>1</sup> / <sub>2</sub>	.33	100/500
JFM40	92023	8-32	<sup>5</sup> / <sub>8</sub>	.36	100/500
JFM85	80123	8-32	<sup>3</sup> / <sub>4</sub>	.48	100/500
JFM86	80124	8-32	1	.55	100/500
JFM87	80125	8-32	<sup>1</sup> / <sub>4</sub>	.64	100/500
JFM88	80126	8-32	<sup>1</sup> / <sub>2</sub>	.77	100/500
JFM106	83906	8-32	<sup>1</sup> / <sub>3</sub>	.87	100/500
JFM89	80127	8-32	2	1.00	100/500
JFM90	80128	8-32	<sup>2</sup> / <sub>2</sub>	1.25	100/500
JFM91	80129	8-32	3	1.46	100/500
JFM117	83917	8-32	<sup>a</sup> / <sub>4</sub>	1.94	100
JFM5	92026	10-24	<sup>1</sup> / <sub>4</sub>	.26	100/500
JFM19	83819	10-24	<sup>3</sup> / <sub>8</sub>	.38	100/500

OTHER SIZES AND QUANTITIES AVAILABLE BY REQUEST

CONTINUED ON NEXT PAGE



CONTINUED

## FLAT HEAD SLOTTED MACHINE SCREWS

STEEL ZINC

PART#	UPC#	DIAMETER	LENGTH	WT. PER PKG.	STD. PKG. UM
JFM32	83832	10-24	½	.50	100/500
JFM41	92024	10-24	⅝	.56	100/500
JFM194	76594	10-24	¾	.58	100/500
JFM113	83913	10-24	1	.76	100/500
JFM109	83909	10-24	1¼	.99	100/500
JFM95	83895	10-24	1½	1.04	100/500
JFM107	92010	10-24	1¾	1.28	100/500
JFM96	83896	10-24	2	1.38	100/500
JFM97	92035	10-24	2½	1.89	100
JFM127	83927	10-24	3	1.96	100
JFM150	84430	10-24	4	2.51	100
JFM152	92041	10-24	5	2.61	100
JFM154	92043	10-24	6	2.87	100
JFM6	83806	10-32	¼	.28	100
JFM20	83820	10-32	⅜	.38	100/500
JFM33	80130	10-32	½	.50	100/500
JFM42	83842	10-32	⅝	.56	100/500
JFM48	80131	10-32	¾	.73	100/500
JFM98	80132	10-32	1	.76	100/500
JFM69	80133	10-32	1¼	.96	100/500
JFM92	81175	10-32	1½	1.04	100/500
JFM108	83908	10-32	1¾	1.23	100/500
JFM93	81176	10-32	2	1.41	100/500
JFM94	81177	10-32	3	2.08	100/500
JFM196	76596	12-24	½	.59	100/500
JFM9	83809	12-24	1	1.04	100/500
JFM195	92050	12-24	1½	1.36	100/500
JFM76	83876	12-24	2	1.73	100/500
JFM7	83807	¼-20	¼	.95	100/500
JFM22	83822	¼-20	⅜	.69	100/500
JFM14	83814	¼-20	⅝	.58	100/500
JFM99	80134	¼-20	½	.89	100/500
JFM44	92025	¼-20	⅝	.93	100/500
JFM100	80135	¼-20	¾	1.06	100/500
JFM101	80136	¼-20	1	1.30	100/500
JFM102	83902	¼-20	1¼	1.54	100/500
JFM103	81900	¼-20	1½	1.83	100/500
JFM110	92012	¼-20	1¾	1.98	100/500
JFM104	80137	¼-20	2	2.55	100/500
JFM128	83928	¼-20	2½	2.81	100
JFM105	81185	¼-20	3	3.38	100
JFM131	92016	¼-20	3½	4.02	100
JFM132	84086	¼-20	4	4.41	100
JFM133	92017	¼-20	5	5.21	100
JFM134	92018	¼-20	6	6.74	100
JFM35	83835	⅝-18	½	.95	100/500
JFM50	83850	⅝-18	¾	1.74	100/500
JFM65	83865	⅝-18	1	2.26	100/500
JFM71	81897	⅝-18	1¼	2.46	100/500
JFM77	81898	⅝-18	1½	2.73	100/500
JFM115	81901	⅝-18	2	2.81	100
JFM122	81902	⅝-18	2½	2.90	100
JFM129	76529	⅝-18	3	5.70	100
JFM36	83836	⅜-16	½	2.06	100/500
JFM51	83851	⅜-16	¾	2.96	100/500

\*WHITE HEAD – OTHER SIZES AND QUANTITIES AVAILABLE BY REQUEST

CONTINUED ON NEXT PAGE  
[www.metallics.us](http://www.metallics.us)



CONTINUED  
**FLAT HEAD SLOTTED MACHINE SCREWS**  
 STEEL ZINC

A

PART#	UPC#	DIAMETER	LENGTH	WT. PER PKG.	STD. PKG. UM
JFM66	83866	3/8-16	1	3.32	100
JFM72	83872	3/8-16	1¼	3.80	100
JFM78	83878	3/8-16	1½	5.41	100
JFM116	83916	3/8-16	2	6.47	100
JFM123	83923	3/8-16	2½	6.94	100
JFM130	84084	3/8-16	3	8.19	100
JFM135	84089	3/8-16	4	2.76	25
FM136	10302	3/8-16	5	3.41	25
FM137	10316	3/8-16	6	4.08	25
JFM114	92013	½-13	1	5.52	100
JFM112	83912	½-13	1¼	6.42	100

\*WHITE HEAD – OTHER SIZES AND QUANTITIES AVAILABLE BY REQUEST



**FLAT HEAD SLOTTED MACHINE SCREWS**  
 18-8 STAINLESS

PART#	UPC#	DIAMETER	LENGTH	WT. PER PKG.	STD. PKG. UM
<b>18-8 STAINLESS</b>					
FM39SS	10267	6-32	5/8	.30	100/500
JFM63SS	91963	6-32	1	.39	100/500
JFM82SS	91982	6-32	1½	.50	100/500
JFM83SS	91983	6-32	2	.60	100/500
JFM142SS	93242	6-32	3	.80	100/500
JFM17SS	91917	8-32	3/8	.28	100/500
JFM84SS	91984	8-32	½	.35	100/500
JFM97SS	91997	8-32	5/8	.41	100/500
JFM85SS	91985	8-32	¾	.45	100/500
JFM95SS	91995	8-32	7/8	.52	100/500
JFM86SS	91986	8-32	1	.56	100/500
JFM110SS	93210	8-32	1 1/8	.60	100/500
JFM87SS	91987	8-32	1¼	.67	100/500
JFM33SS	91933	10-32	½	.49	100/500
JFM48SS	91900	10-32	¾	.71	100/500
JFM92SS	91992	10-32	1½	1.08	100/500
JFM190SS	92850	12-24	½	.60	100/500
JFM194SS	92854	12-24	¾	.98	100/500
JFM193SS	92853	12-24	1	.98	100/500
JFM99SS	91999	¼-20	½	.81	100/500
JFM100SS	92000	¼-20	¾	1.08	100/500
JFM101SS	93201	¼-20	1	1.32	100/500
JFM102SS	93202	¼-20	1¼	1.56	100/500
JFM103SS	93203	¼-20	1½	1.83	100/500
JFM106SS	93206	¼-20	1¾	2.12	100
JFM104SS	93204	¼-20	2	2.55	100
JFM107SS	93207	¼-20	2½	2.89	100
JFM200SS	92860	3/8-16	1	3.39	100

OTHER SIZES AND QUANTITIES AVAILABLE BY REQUEST





## FLAT HEAD PHILLIPS MACHINE SCREWS

STEEL ZINC

PART#	UPC#	DIAMETER	LENGTH	WT. PER PKG.	STD. PKG. UM
JFMP80	84116	6-32	½	.23	100/500
JFMP81	84117	6-32	¾	.33	100/500
JFMP63	84063	6-32	1	.39	100/500
JFMP68	84068	6-32	1¼	.46	100/500
JFMP82	84118	6-32	1½	.54	100/500
JFMP82M	75482	6-32	1½	5.40	1000
JFMP83	84119	6-32	2	.69	100/500
JFMP140	85740	6-32	2½	.83	100/500
JFMP91	84126	6-32	3	1.42	100
JFMP142	85742	6-32	3	.99	100
JFMP64	84064	6-32	4	1.03	100
JFMP4	84054	8-32	¼	.18	100/500
JFMP84	84120	8-32	½	.33	100/500
JFMP85	84121	8-32	¾	.44	100/500
JFMP86	84122	8-32	1	.55	100/500
JFMP87	84123	8-32	1¼	.64	100/500
JFMP89	84125	8-32	2	1.00	100/500
JFMP90	84127	8-32	2½	1.26	100/500
JFMP91	84126	8-32	3	1.51	100/500
JFMP70	84070	10-24	½	.50	100/500
JFMP75	84075	10-24	¾	.48	100/500
JFMP72	84072	10-24	1	.76	100/500
JFMP30	72030	10-24	1¼	.90	100/500
JFMP31	72031	10-24	2	1.41	100/500
JFMP127	85727	10-24	3	2.01	100
JFMP47	72047	10-32	⅜	.40	100/500
JFMP49	72049	10-32	½	.50	100/500
JFMP48	72048	10-32	¾	.60	100/500
JFMP98	84134	10-32	1	.76	100/500
JFMP69	84069	10-32	1¼	.96	100/500
JFMP92	84128	10-32	1½	1.04	100/500
JFMP93	84129	10-32	2	1.41	100/500
JFMP94	84130	10-32	3	2.01	100
JFMP96	84132	10-32	4	1.36	50
JFMP194	85794	12-24	¾	.70	100/500
JFMP22	72022	¼-20	⅜	.63	100/500
JFMP100	85700	¼-20	¾	1.12	100/500
JFMP101	84137	¼-20	1	1.30	100/500
JFMP102	84138	¼-20	1¼	1.56	100
JFMP103	84139	¼-20	1½	1.77	100/500
JFMP105	84141	¼-20	3	3.91	100
JFMP88	84124	8-32	1½	.74	100/500

OTHER SIZES AND QUANTITIES AVAILABLE BY REQUEST



## FLAT HEAD PHILLIPS MACHINE SCREWS

18-8 STAINLESS

PART#	UPC#	DIAMETER	LENGTH	WT. PER PKG.	STD. PKG. UM
<b>18-8 STAINLESS</b>					
JFMP64SS	93464	6-32	¼	.17	100/500
JFMP80SS	91980	6-32	½	.20	100/500
JFMP81SS	93481	6-32	¾	.32	100/500
JFMP63SS	93463	6-32	1	.39	100/500
JFMP68SS	93468	6-32	1¼	.45	100/500
JFMP82SS	93482	6-32	1½	.52	100/500
JFMP83SS	93483	6-32	2	.69	100/500

OTHER SIZES AND QUANTITIES AVAILABLE BY REQUEST

CONTINUED ON NEXT PAGE

www.metallics.us





Phillips

CONTINUED

FLAT HEAD PHILLIPS MACHINE SCREWS

18-8 STAINLESS

PART#	UPC#	DIAMETER	LENGTH	WT. PER PKG.	STD. PKG. UM
<b>18-8 STAINLESS</b>					
JFMP140SS	98440	6-32	2½	2.34	100
JFMP142SS	98442	6-32	3	1.03	100
JFMP84SS	93484	8-32	½	.31	100/500
JFMP85SS	93485	8-32	¾	.44	100/500
JFMP86SS	93486	8-32	1	.56	100/500
JFMP87SS	93487	8-32	1¼	.66	100/500
JFMP88SS	93488	8-32	1½	.73	100/500
JFMP89SS	93489	8-32	2	1.10	100/500
JFMP90SS	93490	8-32	2½	1.17	100
JFMP91SS	93491	8-32	3	1.40	100
JFMP19SS	98500	10-24	¾	.38	100/500
JFMP70SS	93970	10-24	½	.44	100/500
JFMP71SS	93971	10-24	¾	.58	100/500
JFMP72SS	93972	10-24	1	.73	100/500
JFMP127SS	98427	10-24	3	2.01	100
JFMP49SS	93949	10-32	½	.44	100/500
JFMP50SS	93950	10-32	5/8	.53	100/500
JFMP48SS	91948	10-32	¾	.61	100/500
JFMP51SS	93951	10-32	1	.77	100/500
JFMP69SS	93469	10-32	1¼	.89	100/500
JFMP92SS	93492	10-32	1½	1.06	100/500
JFMP93SS	93493	10-32	2	1.34	100/500
JFMP94SS	93494	10-32	3	1.95	100
JFMP99SS	93499	¼-20	½	.78	100/500
JFMP100SS	93500	¼-20	¾	1.15	100/500
JFMP101SS	92280	¼-20	1	1.30	100/500
JFMP102SS	98410	¼-20	1¼	1.57	100/500
JFMP103SS	98403	¼-20	1½	1.83	100/500
JFMP104SS	98404	¼-20	2	2.55	100
JFMP107SS	98407	¼-20	2½	3.03	100
JFMP105SS	98405	¼-20	3	3.51	100
JFMP65SS	93965	5/16-18	1	2.08	100/500
JFMP66SS	98408	5/16-18	1¼	2.54	100
JFMP67SS	98409	5/16-18	1½	2.91	100

OTHER SIZES AND QUANTITIES AVAILABLE BY REQUEST

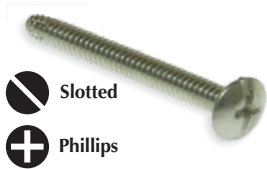

Slotted  
Phillips

TRUSS HEAD COMBO RECEPTACLE AND WIRING DEVICE SCREWS

SLOTTED/PHILLIPS HARDENED TYPE F - STEEL ZINC

PART#	UPC#	DIAMETER	LENGTH	WT. PER PKG.	STD. PKG. UM
TM80	43138	6-32	½	.26	100
TM81	43141	6-32	¾	.37	100
JTM81	84781	6-32	¾	.36	100
TM63	43144	6-32	1	.44	100
JTM63	84763	6-32	1	.42	100
TM63M	43152	6-32	1	3.86	1000
TM68	43147	6-32	1¼	.52	100
TM82	43150	6-32	1½	.62	100
JTM82	84782	6-32	1½	.58	100
TM83	43153	6-32	2	.79	100
JTM83	84783	6-32	2	.74	100

J=JAR PACKAGE – NO J=PLASTIC CLAMSHELL HANGING BOX

OTHER SIZES AND QUANTITIES AVAILABLE BY REQUEST

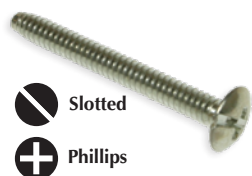

 Slotted  
 Phillips

**TRUSS HEAD COMBO RECEPTACLE  
AND WIRING DEVICE SCREWS**  
SLOTTED/PHILLIPS LEAD POINT - STEEL ZINC



PART#	UPC#	SIZE	SIZE	WT. PER PKG.	STD. PKG. UM
TM80LP	43154	6-32	1/2	.28	100
JTM80LP	43139	6-32	1/2	.28	100
TM81LP	43155	6-32	3/4	.38	100
JTM81LP	43142	6-32	3/4	.38	100
TM81LP4M	41801	6-32	3/4	12.16	4000
TM81LPB	41781	6-32	3/4	34.20	9000
TM63LP	43156	6-32	1	.44	100
JTM63LP	43145	6-32	1	.44	100
TM68LP	43157	6-32	1 1/4	.52	100
JTM68LP	43148	6-32	1 1/4	.52	100
TM82LP	43158	6-32	1 1/2	.59	100
JTM82LP	43151	6-32	1 1/2	.59	100
TM83LP	43159	6-32	2	.72	100

J=JAR PACKAGE – NO J=PLASTIC CLAMSHELL HANGING BOX  
OTHER SIZES AND QUANTITIES AVAILABLE BY REQUEST



 Hex

**SOCKET BUTTON HEAD CAP SCREWS**  
ALLOY STEEL BLACK

PART#	UPC#	DIAMETER	LENGTH	WT. PER PKG.	STD. PKG. UM
JBSC5	72205	4-40	1/2	.18	100/500
JBSC614	66172	6-32	1/4	.20	100/500
JBSC638	66174	6-32	3/8	.23	100/500
JBSC612	66176	6-32	1/2	.26	100/500
JBSC634	66180	6-32	3/4	.31	100/500
JBSC61	66170	6-32	1	.46	100/500
JBSC814	66201	8-32	1/4	.31	100/500
JBSC838	66023	8-32	3/8	.35	100/500
JBSC812	66205	8-32	1/2	.40	100/500
JBSC834	66189	8-32	3/4	.47	100/500
JBSC81	66184	8-32	1	.53	100/500
JBSC8112	66185	8-32	1 1/2	.61	100/500
JBSC82	66186	8-32	2	.72	100/500
JBSC1038	66232	10-24	3/8	.50	100/500
JBSC1012	66234	10-24	1/2	.54	100/500
JBSC1034	66238	10-24	3/4	.69	100/500
JBSC103212	66193	10-32	1/2	.54	100/500
JBSC103234	66195	10-32	3/4	.69	100/500
JBSC10321	66191	10-32	1	.73	100/500
JBSC1032112	66192	10-32	1 1/2	.75	100/500
JBSC10322	66194	10-32	2	.81	100/500
JBSC1438	66261	1/4-20	3/8	.93	100/500
JBSC1412	66263	1/4-20	1/2	1.07	100/500
JBSC1458	66265	1/4-20	5/8	1.14	100/500
JBSC1434	66267	1/4-20	3/4	1.32	100/500
JBSC141	66270	1/4-20	1	1.59	100/500
JBSC14112	66187	1/4-20	1 1/2	2.01	100/500
BSC14112M	32696	1/4-20	1 1/2	20.10	1000
JBSC51638	66415	5/16-18	3/8	1.35	100/500
JBSC51612	66417	5/16-18	1/2	1.40	100/500
JBSC51658	66419	5/16-18	5/8	1.55	100/500
JBSC51634	66421	5/16-18	3/4	1.72	100/500
JBSC51678	66423	5/16-18	7/8	1.89	100/500
JBSC5161	66424	5/16-18	1	2.10	100/500

OTHER SIZES AND QUANTITIES AVAILABLE BY REQUEST



**SOCKET HEAD CAP SCREWS**

ALLOY STEEL BLACK

A

PART#	UPC#	DIAMETER	LENGTH	WT. PER PKG.	STD. PKG. UM
JSHC614	67271	6-32	¼	.27	100/500
JSHC638	67273	6-32	3/8	.33	100/500
JSHC612	67276	6-32	½	.32	100/500
JSHC658	67277	6-32	5/8	.38	100/500
JSHC634	67279	6-32	¾	.41	100/500
JSHC61	67282	6-32	1	.63	100/500
JSHC814	67300	8-32	¼	.27	100/500
JSHC838	67302	8-32	3/8	.42	100/500
JSHC812	67304	8-32	½	.47	100/500
JSHC858	67306	8-32	5/8	.52	100/500
JSHC834	67308	8-32	¾	.58	100/500
JSHC878	67310	8-32	7/8	.63	100/500
JSHC81	67311	8-32	1	.92	100/500
JSHC1038	67331	10-24	3/8	.42	100/500
JSHC1012	67333	10-24	½	.82	100/500
JSHC1058	67335	10-24	5/8	.70	100/500
JSHC1034	67337	10-24	¾	.79	100/500
JSHC1078	67339	10-24	7/8	.92	100/500
JSHC101	67340	10-24	1	.98	100/500
JSHC10114	67343	10-24	1¼	1.13	100/500
JSHC10112	67347	10-24	1½	1.60	100/500
JSHC10134	67351	10-24	1¾	1.79	100/500
JSHC102	67354	10-24	2	1.66	100/500
JSHC1438	67360	¼-20	3/8	1.08	100/500
JSHC1412	67362	¼-20	½	1.14	100/500
JSHC1458	67364	¼-20	5/8	1.25	100/500
JSHC1434	67366	¼-20	¾	1.38	100/500
JSHC1478	67522	¼-20	7/8	1.52	100/500
JSHC141	67523	¼-20	1	1.66	100/500
JSHC14114	67526	¼-20	1¼	1.92	100/500
JSHC14112	67530	¼-20	1½	2.31	100/500
JSHC14134	67534	¼-20	1¾	2.67	100/500
JSHC142	67537	¼-20	2	3.02	100/500
JSHC14414	67568	¼-20	4¼	6.16	100
JSHC51612	67670	5/16-18	½	2.09	100/500
JSHC51658	67672	5/16-18	5/8	2.18	100/500
JSHC51634	67674	5/16-18	¾	2.48	100/500
JSHC51678	67676	5/16-18	7/8	2.32	100/500
JSHC5161	67677	5/16-18	1	2.83	100/500
JSHC516114	67680	5/16-18	1¼	3.31	100/500
JSHC516112	67684	5/16-18	1½	3.91	100/500
JSHC516134	67688	5/16-18	1¾	4.36	100/500
JSHC5162	67691	5/16-18	2	4.98	100/500
JSHC516212	67698	5/16-18	2½	6.09	100
JSHC5163	67978	5/16-18	3	7.75	100
JSHC3812	67824	3/8-16	½	2.91	100
JSHC3858	67826	3/8-16	5/8	3.33	100
JSHC3834	67828	3/8-16	¾	3.80	100
JSHC3878	67830	3/8-16	7/8	4.02	100
JSHC381	67831	3/8-16	1	4.72	100
JSHC38114	67834	3/8-16	1¼	5.20	100
JSHC38112	67838	3/8-16	1½	5.47	100
JSHC38134	67842	3/8-16	1¾	5.74	100
JSHC382	67845	3/8-16	2	1.80	25
JSHC71612	67975	7/16-14	½	4.73	100
JSHC71634	67982	7/16-14	¾	5.03	100
JSHC7161	67985	7/16-14	1	5.83	100
JSHC716114	67988	7/16-14	1¼	7.01	100

OTHER SIZES AND QUANTITIES AVAILABLE BY REQUEST

CONTINUED ON NEXT PAGE

www.metallics.us



CONTINUED  
**SOCKET HEAD CAP SCREWS**  
 ALLOY STEEL BLACK



PART#	UPC#	DIAMETER	LENGTH	WT. PER PKG.	STD. PKG. UM
JSHC716112	67992	7/16-14	1½	8.18	100
JSHC716134	67996	7/16-14	1¾	6.80	100
JSHC7162	67999	7/16-14	2	9.06	100
JSHC71234	68136	½-13	¾	3.46	100
JSHC7121	68139	½-13	1	3.95	100
JSHC712114	68142	½-13	1¼	4.49	100
JSHC712112	68146	½-13	1½	5.20	100
JSHC712134	68150	½-13	1¾	6.00	50
JSHC7122	68153	½-13	2	6.65	50
JSHC712212	86160	½-13	2½	7.48	50
JSHC712234	68164	½-13	2¾	8.15	50
JSHC7123	68167	½-13	3	8.82	50
JSHC712312	68174	½-13	3½	9.72	50
JSHC7124	68181	½-13	4	11.50	50
JSHC581	68293	5/8-11	1	4.25	50
JSHC58114	68296	5/8-11	1¼	4.50	50
JSHC58112	68300	5/8-11	1½	4.62	50
JSHC58134	68304	5/8-11	1¾	4.89	50
JSHC582	68307	5/8-11	2	5.50	50
JSHC58214	68310	5/8-11	2¼	3.50	25
JSHC58212	68314	5/8-11	2½	3.75	25
JSHC58234	68318	5/8-11	2¾	4.00	25
JSHC583	68321	5/8-11	3	4.50	25
JSHC58312	68328	5/8-11	3½	5.00	25
JSHC584	68335	5/8-11	4	5.75	25
JSHC58412	58342	5/8-11	4½	6.30	25
JSHC585	68349	5/8-11	5	7.25	25
JSHC34114	68444	¾-10	1¼	2.35	25
JSHC34112	68447	¾-10	1½	2.48	25
JSHC34134	68458	¾-10	1¾	2.75	25
JSHC342	68461	¾-10	2	3.10	25
JSHC34214	68464	¾-10	2¼	3.75	25
JSHC34212	68468	¾-10	2½	4.10	25
JSHC343	68475	¾-10	3	4.89	25
JSHC34312	68482	¾-10	3½	5.26	25
JSHC344	68489	¾-10	4	6.29	25
JSHC345	68503	¾-10	5	7.78	25

OTHER SIZES AND QUANTITIES AVAILABLE BY REQUEST



**SOCKET HEAD CAP SCREWS**  
 18-8 STAINLESS • 316 STAINLESS

PART#	UPC#	DIAMETER	LENGTH	WT. PER PKG.	STD. PKG. UM
<b>18-8 STAINLESS</b>					
JSHC614SS	91165	6-32	¼	.27	100/500
JSHC612SS	91163	6-32	½	.32	100/500
JSHC634SS	91167	6-32	¾	.41	100/500
JSHC61SS	91129	6-32	1	.49	100/500
JSHC838SS	91391	8-32	3/8	.42	100/500
JSHC812SS	91932	8-32	½	.47	100/500
JSHC858SS	91393	8-32	5/8	.52	100/500
JSHC834SS	91394	8-32	¾	.58	100/500
JSHC81SS	91395	8-32	1	.71	100/500
JSHC614SS	91165	6-32	¼	.27	100/500
JSHC612SS	91163	6-32	½	.32	100/500
JSHC634SS	91167	6-32	¾	.41	100/500
JSHC61SS	91129	6-32	1	.49	100/500

OTHER SIZES AND QUANTITIES AVAILABLE BY REQUEST



SOCKET HEAD CAP SCREWS

18-8 STAINLESS • 316 STAINLESS

PART#	UPC#	DIAMETER	LENGTH	WT. PER PKG.	STD. PKG. UM
<b>18-8 STAINLESS</b>					
JSHC838SS	91391	8-32	3/8	.42	100/500
JSHC812SS	91932	8-32	1/2	.47	100/500
JSHC858SS	91393	8-32	5/8	.52	100/500
JSHC834SS	91394	8-32	3/4	.58	100/500
JSHC81SS	91395	8-32	1	.71	100/500
JSHC1012SS	91455	10-24	1/2	.82	100/500
JSHC1034SS	91477	10-24	3/4	.79	100/500
JSHC101SS	91139	10-24	1	.98	100/500
JSHC102SS	91140	10-24	2	1.66	100/500
JSHC3212SS	91271	10-32	1/2	.67	100/500
JSHC3234SS	91150	10-32	3/4	.81	100/500
JSHC321SS	91273	10-32	1	.98	100/500
JSHC325SS	91277	10-32	2	1.67	100/500
JSHC1412SS	91145	1/4-20	1/2	1.14	100/500
JSHC1434SS	93663	1/4-20	3/4	1.41	100/500
JSHC1458SS	93661	1/4-20	5/8	1.25	100/500
JSHC141SS	93667	1/4-20	1	1.66	100/500

OTHER SIZES AND QUANTITIES AVAILABLE BY REQUEST



SOCKET HEAD METRIC CAP SCREWS

18-8 STAINLESS • 316 STAINLESS • STEEL BLACK

PART#	UPC#	DIAMETER	LENGTH	WT. PER PKG.	STD. PKG. UM
<b>18-8 STAINLESS</b>					
JMSHC36SS	91316	M3	6mm	.21	100
JMSHC34SS	91314	M3	14mm	.29	100
JMSHC412SS	91309	M4	12mm	.48	100
JMSHC420SS	91311	M4	20mm	.60	100
JMSHC512SS	91310	M5	12mm	.78	100
JMSHC520SS	91312	M5	20mm	.95	100
JMSHC1230SS	91307	M12	30mm	9.44	100
<b>316 STAINLESS</b>					
MSHC305316SS	20872	M3	25mm	2.76	2500
<b>STEEL BLACK</b>					
JMSHC258	91315	M2.5	8mm	.17	100
JMSHC650	91306	M6	50mm	1.98	100
JMSHC1245	91308	M12	45mm	6.92	100

OTHER SIZES AND QUANTITIES AVAILABLE BY REQUEST



PAN HEAD TRI-DRIVE  
TELECOM CABINET SCREWS

STEEL ZINC • BLACK OXIDE

For Use In Telecom Cabinets, Relay Racks And Patch Panels



PART#	UPC#	DIAMETER	LENGTH	WT. PER PKG.	STD. PKG. UM
<b>STEEL ZINC</b>					
JTEL1032	84440	10-32	5/8	.64	100/500
JTEL103234	84442	10-32	3/4	.74	100/500
JTEL1224	84445	12-24	5/8	.48	50/250
TEL1224	39096	12-24	5/8	.48	50/250
JTEL1228	84450	12-28	5/8	.48	50/250
TEL1228	39095	12-28	5/8	.52	50/250

OTHER SIZES AND QUANTITIES AVAILABLE BY REQUEST

CONTINUED ON NEXT PAGE

www.metallics.us

CONTINUED

**PAN HEAD TRI-DRIVE  
TELECOM CABINET SCREWS**

STEEL ZINC • BLACK OXIDE

*For Use In Telecom Cabinets, Relay Racks And Patch Panels*

MADE IN USA



PART#	UPC#	DIAMETER	LENGTH	WT. PER PKG.	STD. PKG. UM
<b>BLACK OXIDE</b>					
TEL1024BLK	39250	10-24	5/8	.31	50/250
JTEL1024BLK	84444	10-24	5/8	.62	100/500
TEL1032BLK	39260	10-32	5/8	.33	50/250
JTEL1032BLK	84441	10-32	5/8	.64	100/500
TEL1032BLKV	39262	10-32	5/8	3.06	500
TEL1224BLK	39097	12-24	5/8	.48	50/250
JTEL1224BLK	84446	12-24	5/8	.85	100/500
TEL1224BLKV	39099	12-24	5/8	4.08	500

OTHER SIZES AND QUANTITIES AVAILABLE BY REQUEST



**FLAT HEAD PHILLIPS TAPPING SCREWS**

STEEL ZINC • 18-8 STAINLESS

PART#	UPC#	DIAMETER	LENGTH	WT. PER PKG.	STD. PKG. UM
<b>STEEL ZINC</b>					
JTSF10	81861	4	1/2	.15	100/500
JTSF101	81995	4	3/4	.20	100/500
JTSF11	81862	4	1	.25	100/500
JTSF13	83024	4	1 1/2	.34	100/500
JTSF7	83021	6	3/8	.18	100/500
JTSF12	80225	6	1/2	.23	100/500
JTSF14	80226	6	3/4	.30	100/500
JTSF15	80227	6	1	.35	100/500
JTSF9	80228	6	1 1/4	.40	100/500
JTSF38	83036	6	1 1/2	.49	100/500
JTSF16	81863	6	2	.63	100/500
JTSF44	81592	6	2 1/2	.79	100/500
JTSF17	83025	8	3/8	.25	100/500
JTSF18	81865	8	1/2	.26	100/500
JTSF20	80229	8	3/4	.36	100/500
JTSF21	80230	8	1	.46	100/500
TSF21V	10541	8	1	2.10	500
JTSF22	80231	8	1 1/4	.59	100/500
TSF22M	10518	8	1 1/4	5.90	1000
JTSF23	80232	8	1 1/2	.67	100/500
JTSF45	81593	8	1 3/4	.76	100/500
JTSF24	83027	8	2	.86	100/500
TSF24M	10519	8	2	8.60	1000
JTSF26	83029	8	2 1/2	1.05	100/500
TSF26M	10513	8	2 1/2	10.50	1000
JTSF19	83026	8	3	1.32	100
JTSF25	83028	10	1/2	.35	100/500
JTSF27	80233	10	3/4	.52	100/500
JTSF28	80234	10	1	.61	100/500
JTSF29	80235	10	1 1/4	.75	100/500
JTSF29V	81997	10	1 1/4	3.64	500
JTSF30	80236	10	1 1/2	.85	100/500
JTSF43	78243	10	1 3/4	.95	100/500
JTSF31	81866	10	2	1.15	100/500
JTSF42	78242	10	2 1/2	1.35	100
JTSF39	81998	10	3	1.66	100

OTHER SIZES AND QUANTITIES AVAILABLE BY REQUEST

CONTINUED ON NEXT PAGE  
www.metallics.us



CONTINUED

FLAT HEAD PHILLIPS TAPPING SCREWS

STEEL ZINC • 18-8 STAINLESS



Phillips

A

PART#	UPC#	DIAMETER	LENGTH	WT. PER PKG.	STD. PKG. UM
<b>STEEL ZINC</b>					
JTSF32	83030	12	½	.49	100/500
JTSF33	83031	12	¾	.68	100/500
JTSF34	83032	12	1	.85	100/500
JTSF35	83033	12	1¼	.95	100/500
JTSF36	83034	12	1½	.92	100/500
JTSF37	83035	12	2	1.40	100
JTSF41	78241	12	2½	1.86	100
JTSF40	83038	12	3	2.06	100
JTSF57	78257	14	¾	.87	100/500
JTSF59	78259	14	1	1.01	100/500
JTSF60	78260	14	1¼	1.30	100/500
JTSF61	78261	14	1½	1.46	100/500
JTSF62	78262	14	2	2.34	100/500
<b>18-8 STAINLESS</b>					
JTSF7SS	99707	6	⅜	.12	100/500
JTSF18SS	99718	8	½	.31	100/500
JTSF39SS	99729	14	1½	1.52	100

OTHER SIZES AND QUANTITIES AVAILABLE BY REQUEST



Slotted

PAN HEAD SLOTTED TAPPING SCREWS

18-8 STAINLESS

PART#	UPC#	DIAMETER	LENGTH	WT. PER PKG.	STD. PKG. UM
JSTS10	80206	6	½	.25	100/500
JSTS11	80207	6	¾	.32	100/500
JSTS12	80208	6	1	.33	100/500
JSTS38	12236	6	1½	.58	100/500
JSTS38	12236	6	1½	.58	100/500
JSTS50	12241	8	¼	.25	100/500
JSTS13	80209	8	½	.34	100/500
JSTS14	80210	8	¾	.47	100/500
JSTS15	80211	8	1	.54	100/500
JSTS16	80212	8	1¼	.63	100/500
JSTS17	80213	8	1½	.74	100/500
JSTS18	80214	8	2	.92	100/500
JSTS19	80215	10	½	.48	100/500
JSTS20	80216	10	⅝	.52	100/500
JSTS21	80217	10	¾	.60	100/500
JSTS22	80218	10	1	.70	100/500
JSTS23	80219	10	1¼	.87	100/500
JSTS24	80220	10	1½	.98	100/500
JSTS25	80221	10	2	1.23	100/500
JSTS26	80222	12	½	.66	100/500
JSTS27	80223	12	¾	.88	100/500
JSTS28	80224	12	1	.94	100/500
JSTS1412	12243	14	½	.83	100
JSTS60	12244	14	1½	1.84	100

OTHER SIZES AND QUANTITIES AVAILABLE BY REQUEST



## PAN HEAD PHILLIPS TAPPING SCREWS

18-8 STAINLESS

PART#	UPC#	DIAMETER	LENGTH	WT. PER PKG.	STD. PKG. UM
<b>18-8 STAINLESS</b>					
JSTSP41	84031	4	1/2	.20	100/500
JSTSP42	84031	4	3/4	.23	100/500
JSTSP39	84039	6	3/8	.23	100/500
JSTSP10	84010	6	1/2	.27	100/500
JSTSP11	84011	6	3/4	.29	100/500
JSTSP12	84012	6	1	.42	100/500
JSTSP40	84040	6	1 1/4	.48	100/500
JSTSP125	84427	6	1 1/2	.54	100/500
JSTSP37	84037	8	3/8	.19	100/500
JSTSP13	84013	8	1/2	.39	100/500
JSTSP14	84014	8	3/4	.47	100/500
JSTSP15	84015	8	1	.58	100/500
JSTSP16	84016	8	1 1/4	.67	100/500
JSTSP17	84017	8	1 1/2	.76	100/500
JSTSP18	84018	8	2	.98	100/500
JSTSP19	84019	10	1/2	.52	100/500
JSTSP20	84020	10	5/8	.61	100/500
JSTSP21	84021	10	3/4	.64	100/500
JSTSP22	84022	10	1	.77	100/500
JSTSP23	84023	10	1 1/4	1.22	100/500
JSTSP24	84024	10	1 1/2	.98	100/500
JSTSP25	84025	10	2	1.46	100/500
JSTSP29	84029	10	3	1.81	100
JSTSP26	84026	12	1/2	.49	100/500
JSTSP27	84027	12	3/4	.88	100/500
JSTSP28	84028	12	1	1.05	100/500
JSTSP33	84033	12	1 1/4	1.22	100/500
JSTSP32	84032	12	1 1/2	1.37	100/500
JSTSP34	84034	12	2	1.68	100
JSTSP35	84035	12	3	2.51	100
JSTSP30	84030	14	3/4	1.15	100/500
JSTSP38	84038	14	1 1/2	1.84	100/500
JSTSP31	84031	14	2	2.40	100/500
JSTSP36	84036	1/4	1	1.43	100/500

OTHER SIZES AND QUANTITIES AVAILABLE BY REQUEST



Slotted



Phillips



Square Drive



## PAN HEAD TRI-DRIVE TAPPING SCREWS

STEEL ZINC

Introduced nationally in 1994 by Metallics

MADE IN USA





PART#	UPC#	DIAMETER	LENGTH	WT. PER PKG.	STD. PKG. UM
JTTS12	80138	6	1/2	.29	100/500
JTTS14	80139	6	3/4	.36	100/500
JTTS14M	75500	6	3/4	3.60	1000
JTTS15	80140	6	1	.42	100/500
JTTS38	80141	6	1 1/2	.56	100/500
JTTS18	80142	8	1/2	.37	100/500
JTTS20	80143	8	3/4	.48	100/500
JTTS21	80144	8	1	.58	100/500
TTS21-5M	17321	8	1	5.80	5000
JTTS22	80145	8	1 1/4	.64	100/500
JTTS23	80146	8	1 1/2	.75	100/500
JTTS24	80147	8	2	.97	100/500

OTHER SIZES AND QUANTITIES AVAILABLE BY REQUEST

CONTINUED ON NEXT PAGE  
[www.metallics.us](http://www.metallics.us)





-  Slotted
-  Phillips
-  Square Drive



CONTINUED  
**PAN HEAD TRI-DRIVE  
TAPPING SCREWS**

STEEL ZINC

*Introduced nationally in 1994 by Metallics*



PART#	UPC#	DIAMETER	LENGTH	WT. PER PKG.	STD. PKG. UM
JTTS25	80148	10	½	.50	100/500
JTTS27	80149	10	¾	.64	100/500
JTTS28	80150	10	1	.75	100/500
JTTS29	80151	10	1¼	.88	100/500
JTTS30	80152	10	1½	1.01	100/500
JTTS31	80153	10	2	1.26	100/500
TTS31B	27125	10	2	20.16	1600
JTTS33	80154	12	¾	.82	100/500
TTS33B	27124	12	¾	18.64	2440
JTTS34	80155	12	1	.98	100/500
JTTS35	80156	12	1¼	1.23	100/500
JTTS36	80157	12	1½	1.32	100/500
JTTS37	80158	12	2	1.68	100

OTHER SIZES AND QUANTITIES AVAILABLE BY REQUEST



-  Square Drive

**PAN HEAD SQUARE DRIVE  
TAPPING SCREWS**

STEEL ZINC • 18-8 STAINLESS

PART#	UPC#	DIAMETER	LENGTH	WT. PER PKG.	STD. PKG. UM
<b>STEEL ZINC</b>					
JTSS1	80237	6	½	.26	100/500
JTSS2	80238	6	¾	.35	100/500
JTSS3	80239	6	1	.40	100/500
JTSS4	80240	6	1¼	.43	100/500
JTSS5	80241	6	1½	.54	100/500
JTSS6	80242	6	2	.66	100/500
JTSS7	80243	8	½	.38	100/500
JTSS8	80244	8	¾	.49	100/500
JTSS9	80245	8	1	.59	100/500
JTSS10	80246	8	1¼	.66	100/500
JTSS11	80247	8	1½	.77	100/500
JTSS12	80248	8	2	.92	100/500
JTSS25	80249	10	½	.49	100/500
JTSS27	80250	10	¾	.62	100/500
JTSS28	80251	10	1	.76	100/500
JTSS29	80252	10	1¼	.90	100/500
JTSS30	80253	10	1½	1.02	100/500
JTSS31	80254	10	2	1.29	100/500
JTSS32	80255	10	2½	1.58	100
JTSS81	80256	10	3	1.73	100
JTSS33	80257	12	¾	.88	100/500
JTSS34	80258	12	1	1.04	100/500
JTSS35	80259	12	1¼	1.28	100/500
JTSS36	80260	12	1½	1.38	100/500
JTSS37	80261	12	2	1.75	100
JTSS83	80262	12	3	2.44	100
JTSS83V	96844	12	3	11.92	500
<b>18-8 STAINLESS</b>					
JTSS7SS	96407	8	½	.39	100/500
JTSS8SS	96408	8	¾	.51	100/500
JTSS9SS	96409	8	1	.60	100/500

OTHER SIZES AND QUANTITIES AVAILABLE BY REQUEST

CONTINUED ON NEXT PAGE

[www.metallics.us](http://www.metallics.us)

CONTINUED

## PAN HEAD SQUARE DRIVE TAPPING SCREWS

STEEL ZINC • 18-8 STAINLESS

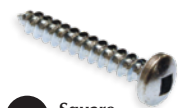

PART#	UPC#	DIAMETER	LENGTH	WT. PER PKG.	STD. PKG. UM
<b>18-8 STAINLESS</b>					
JTSS10SS	96410	8	1¼	.68	100/500
JTSS11SS	96411	8	1½	.79	100/500
JTSS25SS	96425	10	½	.52	100/500
JTSS27SS	96427	10	¾	.60	100/500
JTSS28SS	96428	10	1	.99	100/500
JTSS29SS	96429	10	1¼	.87	100/500
JTSS30SS	96430	10	1½	.94	100/500
JTSS31SS	96431	10	2	1.25	100/500
JTSS81SS	96841	10	3	1.82	100/500

OTHER SIZES AND QUANTITIES AVAILABLE BY REQUEST

## ROUND WASHER HEAD SQUARE/PHILLIPS TAPPING SCREWS

STEEL ZINC

MADE IN USA



PART#	UPC#	DIAMETER	LENGTH	WT. PER PKG.	STD. PKG. UM
<b>100 PACK</b>					
JRWS7	80263	8	½	.41	100/500
JRWS8	80264	8	¾	.52	100/500
JRWS9	80265	8	1	.59	100/500
JRWS10	80266	8	1¼	.69	100/500
JRWS11	80267	8	1½	.83	100/500
JRWS12	80268	8	2	1.00	100/500
JRWS26	80269	10	½	.55	100/500
JRWS27	80270	10	¾	.68	100/500
JRWS28	80271	10	1	.81	100/500
JRWS29	80272	10	1¼	.89	100/500
JRWS30	80273	10	1½	1.10	100/500
JRWS31	80274	10	2	1.30	100/500
<b>500 PACK</b>					
JRWS7V	97607	8	½	2.05	500
JRWS8V	97608	8	¾	2.60	500
JRWS9V	97609	8	1	2.95	500
JRWS10V	97610	8	1¼	3.45	500
JRWS11V	97611	8	1½	4.15	500
JRWS12V	97612	8	2	5.00	500
JRWS26V	97626	10	½	2.75	500
JRWS27V	97627	10	¾	3.16	500
JRWS28V	97628	10	1	4.05	500
JRWS29V	97629	10	1¼	4.45	500
JRWS30V	97630	10	1½	5.50	500
JRWS31V	97631	10	2	6.38	500
<b>BULK</b>					
RWS75B	54030	8	½	17.90	5000
RWS710B	54031	8	½	35.82	10000
JRWS10M	88910	8	1¼	6.90	1000
RWS105B	54052	8	1¼	34.50	5000
JRWS29M	88929	10	1¼	8.94	1000
<b>WHITE</b>					
JRWS12W	60420	8	2	1.00	100

OTHER SIZES AND QUANTITIES AVAILABLE BY REQUEST



**PAN HEAD SLOTTED/PHILLIPS/  
COMBO TAPPING SCREWS**  
STEEL ZINC

PART#	UPC#	DIAMETER	LENGTH	WT. PER PKG.	STD. PKG. UM
<b>SLOTTED</b>					
JTS85	86204	6	1¾	.60	100/500
JTS65	82584	14	2½	2.69	100
TS65B	98365	14	2½	48.42	1800
TS66	10585	14	3	3.08	100
TS66M	73466	14	3	31.73	1000
<b>PHILLIPS</b>					
TS0-10M	10350	2	5/16	5.30	10000
JTSP12	98188	6	½	.26	100
TSP10M	97085	6	5/8	2.80	1000
JTSP14	98189	6	¾	.33	100
TSP14M	97086	6	¾	3.30	1000
TSP15M	97087	6	1	3.90	1000
JTSP39	98183	6	2	.66	100/500
JTSP16	95247	8	¼	.29	100/500
TSP17M	97088	8	5/8	3.50	1000
JTSP20	98178	8	¾	.42	100/500
TSP18M	97089	8	1	5.70	1000
TSP19M	97090	8	1¼	6.60	1000
JTSP23	12843	8	1½	.73	100/500
TSP85B	12861	8	2½	32.50	3000
JTSP43	98185	8	3	1.41	100
JTSP27	98182	10	¾	.61	100
JTSP28	98179	10	1	.74	100
TSP28M	97091	10	1	7.40	1000
JTSP29	98180	10	1¼	.93	100/500
TSP29M	97092	10	1¼	9.30	1000
JTSP30	98181	10	1½	.99	100/500
TS99	82618	10	4	2.39	100
TSP80M	97093	12	½	6.50	1000
TSP81M	97094	12	5/8	7.40	1000
TSP82M	97095	12	¾	7.90	1000
TSP83M	97096	12	1	10.00	1000
TSP84M	97097	12	1¼	11.50	1000
JTSP85	97098	12	1½	1.33	100
JTSP87	97099	12	2	1.60	100
JTSP86	98186	12	4	3.01	100
TSP67B	12859	14	2¼	19.90	800
TSP68V	98184	14	3½	19.16	500
TSP70B	12862	14	4	12.68	300
<b>COMBO</b>					
JTS1	82553	4	¼	.14	100/500
JTS2	82554	4	3/8	.17	100/500
JTS10	80159	4	½	.20	100/500
JTS3	82555	4	5/8	.22	100/500
JTS4	80160	4	¾	.23	100/500
JTS11	80161	4	1	.28	100/500
JTS6	80162	6	¼	.19	100/500
JTS7	80163	6	3/8	.23	100/500
JTS12	80164	6	½	.26	100/500
JTS12M	73412	6	½	2.60	1000
JTS13	80165	6	5/8	.28	100/500
JTS14	80166	6	¾	.33	100/500
JTS14M	81171	.6	¾	3.30	1000
JTS15	80167	6	1	.39	100/500
JTS15M	73415	6	1	3.53	1000

OTHER SIZES AND QUANTITIES AVAILABLE BY REQUEST

CONTINUED

PAN HEAD SLOTTED/PHILLIPS/  
COMBO TAPPING SCREWS  
STEEL ZINC



PART#	UPC#	DIAMETER	LENGTH	WT. PER PKG.	STD. PKG. UM
<b>PHILLIPS</b>					
JTS9	80168	6	1¼	.47	100/500
JTS38	80169	6	1½	.53	100/500
JTS85	86204	6	1¾	.60	100/500
JTS39	82558	6	2	.66	100/500
JTS40	80170	7	½	.31	100/500
JTS42	82570	7	¾	.39	100/500
JTS44	82572	7	1	.48	100/500
JTS17	80171	8	¾	.32	100/500
JTS18	80172	8	½	.37	100/500
JTS18M	81172	8	½	3.20	1000
JTS19	80173	8	⅝	.41	100/500
TS19M	10514	8	⅝	4.10	10000
JTS20	80174	8	¾	.47	100/500
JTS21	80175	8	1	.57	100/500
JTS21M	81173	8	1	5.09	1000
TS215M	17323	8	1	25.47	5000
TS2110M	17324	8	1	51.11	10000
JTS22	80176	8	1¼	.66	100/500
TS22B	90722	8	1¼	9.90	1500
TS225M	17325	8	1¼	29.89	5000
TS22M	10515	8	1¼	6.60	1000
JTS23	80177	8	1½	.73	100/500
TS23M	10516	8	1½	7.30	1000
JTS48	80178	8	1¾	.86	100/500
JTS24	80179	8	2	1.00	100/500
TS24M	10517	8	2	10.00	1000
JTS84	82603	8	2½	1.14	100
JTS49	80180	10	¾	.44	100/500
JTS25	80181	10	½	.50	100/500
JTS25M	73425	10	½	4.57	1000
TS25B	90725	10	½	47.82	10000
JTS26	80182	10	⅝	.57	100/500
JTS27	80183	10	¾	.63	100/500
JTS27V	95248	10	¾	2.95	500
JTS27M	73427	10	¾	5.90	1000
TS27B	20336	10	1	22.84	4000
JTS28	80184	10	1	.74	100/500
JTS28V	95249	10	1	3.75	500
TS285M	17326	10	1	34.14	5000
TS28B	90728	10	1	68.55	10000
JTS29	80185	10	1¼	.86	100/500
JTS29M	73429	10	1¼	8.07	1000
TS29B	90729	10	1¼	80.25	10000
JTS30	80186	10	1½	.95	100/500
JTS30M	73430	10	1½	9.40	1000
TS30B	90730	10	1½	47.00	5000
JTS51	80187	10	1¾	1.14	100/500
JTS51M	73451	10	1¾	11.12	1000
JTS31	80188	10	2	1.29	100/500
JTS80	80189	10	2½	1.54	100
JTS81	80190	10	3	1.82	100
TS81M	72981	10	3	17.65	1000

OTHER SIZES AND QUANTITIES AVAILABLE BY REQUEST



CONTINUED  
**PAN HEAD SLOTTED/PHILLIPS/COMBO**  
**TAPPING SCREWS**  
 STEEL ZINC

PART#	UPC#	DIAMETER	LENGTH	WT. PER PKG.	STD. PKG. UM
<b>COMBO</b>					
JTS32	80191	12	1/2	.65	100/500
JTS52	82577	12	5/8	.74	100/500
JTS33	80192	12	3/4	.79	100/500
JTS33M	73433	12	3/4	7.90	1000
JTS34	80193	12	1	1.00	100/500
TS34B	90734	12	1	50.00	5000
JTS35	80194	12	1 1/4	1.15	100/500
JTS36	80195	12	1 1/2	1.33	100/500
JTS54	80196	12	1 3/4	1.53	100/500
JTS37	80197	12	2	1.60	100
JTS82	80198	12	2 1/2	2.06	100
JTS83	80199	12	3	2.37	100
JTS55	80200	14	1/2	.93	100/500
TS55B	98355	14	1/2	45.15	5000
JTS56	81174	14	5/8	1.03	100/500
JTS57	80201	14	3/4	1.13	100/500
TS57B	98357	14	3/4	32.53	3000
JTS59	80202	14	1	1.44	100/500
TS59B	98359	14	1	38.80	3000
JTS60	80203	14	1 1/4	1.55	100/500
TS60B	98360	14	1 1/4	34.03	2000
JTS61	80204	14	1 1/2	1.84	100/500
TS61B	98361	14	1 1/2	52.90	3000
JTS62	82582	14	1 3/4	2.04	100
TS62B	98362	14	1 3/4	36.13	1800
JTS63	80205	14	2	2.34	100
TS63B	98363	14	2	34.78	1500
JTS47	81999	14	3	3.19	100

OTHER SIZES AND QUANTITIES AVAILABLE BY REQUEST



**INDENTED HEX HEAD SLOTTED**  
**TAPPING SCREWS**  
 STEEL ZINC • 18-8 STAINLESS

PART#	UPC#	DIAMETER	LENGTH	WT. PER PKG.	STD. PKG. UM
<b>STEEL ZINC</b>					
<b>1/4 HEAD</b>					
JDS150	10700	6	3/8	.27	100/500
JDS150V	97450	6	3/8	1.35	500
JDS150M	53089	6	3/8	2.70	1000
JDS161	10701	6	1/2	.30	100/500
JDS161V	97461	6	1/2	1.50	500
JDS161M	88062	6	1/2	2.43	1000
JDS160	10702	6	3/4	.37	100/500
JDS160V	97460	6	3/4	1.85	500
JDS163	10703	6	1	.43	100/500
JDS163V	97463	6	1	2.15	500
JDS164	10704	6	1 1/4	.51	100/500
JDS164V	97464	6	1 1/4	2.55	500
JDS165	10705	6	1 1/2	.62	100/500
JDS165V	97465	6	1 1/2	3.10	500

OTHER SIZES AND QUANTITIES AVAILABLE BY REQUEST

CONTINUED

## INDENTED HEX HEAD SLOTTED TAPPING SCREWS

STEEL ZINC • 18-8 STAINLESS



PART#	UPC#	DIAMETER	LENGTH	WT. PER PKG.	STD. PKG. UM
<b>STEEL ZINC</b>					
<b>1/4 HEAD</b>					
JDS151	10709	7	½	.33	100/500
JDS151V	97451	7	½	1.65	500
JDS166	10710	7	¾	.43	100/500
JDS166V	97466	7	¾	1.80	500
JDS152	10715	8	½	.37	100/500
JDS152V	97452	8	½	1.85	500
JDS152M	14795	8	½	3.11	1000
DS1525M	26515	8	½	15.94	5000
DS152B	14552	8	½	37.00	10000
JDS153	10716	8	¾	.45	100/500
JDS153V	97453	8	¾	2.25	500
JDS153M	14796	8	¾	4.50	1000
JDS155	10725	10	½	.37	100/500
JDS155V	97455	10	½	1.85	500
JDS156	10726	10	¾	.51	100/500
JDS156V	97456	10	¾	2.55	500
JDS158	10727	10	1	.61	100/500
JDS158V	97458	10	1	3.05	500
JDS168	10729	10	1½	.88	100/500
JDS168V	97468	10	1½	4.23	500
JDS169	10730	10	2	1.12	100/500
<b>5/16 HEAD</b>					
JDS169V	97469	10	2	5.60	500
JDS180	10760	10	½	.55	100/500
JDS180V	97480	10	½	2.75	500
JDS88	10761	10	5/8	.51	100/500
JDS181	80296	10	¾	.63	100/500
JDS181V	97481	10	¾	3.15	500
DS181B	92181	10	¾	17.87	3000
JDS182	10762	10	1	.75	100/500
JDS182V	92782	10	1	1.15	500
JDS182M	97500	10	1	6.10	1000
DS182B	92182	10	1	29.25	4000
JDS183	10763	10	1¼	.89	100/500
JDS183V	97483	10	1¼	4.30	500
DS183M	88083	10	1¼	2.47	1000
JDS184	10764	10	1½	1.03	100/500
JDS184V	97484	10	1½	5.00	500
DS184M	88084	10	1½	9.68	1000
DS184B	10754	10	1½	29.04	3000
JDS185	10766	10	2	1.30	100
JDS185V	97485	10	2	6.25	500
DS185M	10786	10	2	12.00	1000
DS185B	92185	10	2	39.11	3125
JDS80	10780	10	2½	1.53	100
JDS80V	97380	10	2½	7.75	500
DS80M	82780	10	2½	14.74	1000
JDS81	10751	10	3	1.81	100
JDS81V	97381	10	3	9.05	500
JDS87	81711	10	4	2.29	100
JDS186	10767	12	½	.67	100/500
JDS170	10735	12	¾	.79	100/500

OTHER SIZES AND QUANTITIES AVAILABLE BY REQUEST

CONTINUED ON NEXT PAGE  
[www.metallics.us](http://www.metallics.us)



CONTINUED  
**INDENTED HEX HEAD SLOTTED  
 TAPPING SCREWS**  
 STEEL ZINC • 18-8 STAINLESS

PART#	UPC#	DIAMETER	LENGTH	WT. PER PKG.	STD. PKG. UM
<b>STEEL ZINC</b>					
<b>5/16 HEAD</b>					
JDS170V	97470	12	3/4	3.95	500
JDS171	10736	12	1	1.00	100/500
JDS171V	97471	12	1	5.00	500
DS1715M	13979	12	1	48.17	5000
JDS172	10737	12	1 1/4	1.17	100/500
JDS172V	97472	12	1 1/4	5.85	500
DS172M	69772	12	1 1/4	11.70	1000
JDS173	10738	12	1 1/2	1.32	100/500
JDS173V	97473	12	1 1/2	6.60	500
DS1735M	13981	12	1 1/2	66.50	5000
JDS174	80307	12	2	1.66	100
JDS174V	97474	12	2	8.15	500
DS174M	69774	12	2	16.35	1000
DS1745M	69799	12	2	83.00	5000
JDS86	81710	12	2 1/2	2.05	100
JDS83	10752	12	3	2.47	100
DS835M	10782	12	3	23.50	5000
<b>3/8 HEAD</b>					
JDS85	81709	14	1/2	.94	100/500
JDS191	81772	14	5/8	1.17	100/500
JDS175	10744	14	3/4	.97	100/500
JDS175V	97475	14	3/4	4.85	500
JDS176	10745	14	1	1.53	100/500
JDS176V	97476	14	1	7.65	500
JDS177	10746	14	1 1/4	1.70	100
JDS177V	97477	14	1 1/4	8.50	500
JDS178	10747	14	1 1/2	1.96	100
DS178M	10749	14	1 1/2	19.60	1000
JDS178V	97478	14	1 1/2	10.05	500
JDS179	10748	14	2	2.45	100
DS179V	97479	14	2	12.25	500
DS179M	10753	14	2	24.50	1000
JDS187	81768	14	2 1/2	2.91	100
JDS143	10750	14	3	3.38	100
JDS143V	97443	14	3	16.90	500
<b>STEEL ZINC</b>					
<b>1/2 HEAD</b>					
JDS5161	90401	5/16	1	2.77	100/500
<b>18-8 STAINLESS</b>					
<b>1/4 HEAD</b>					
JDS152SS	92752	8	1/2	.38	100/500
JDS153SS	92753	8	3/4	.46	100/500
JDS154SS	92754	8	1	.54	100/500
JDS162SS	92762	8	1 1/4	.69	100/500
JDS157SS	92757	8	1 1/2	.77	100/500
JDS159SS	92759	8	2	.98	100/500
JDS192SS	92792	8	3	1.40	100
JDS158SS	92758	10	1	.81	100/500
<b>5/16 HEAD</b>					
JDS180SS	92780	10	1/2	.52	100/500
JDS181SS	92781	10	3/4	.67	100/500
JDS182SS	92782	10	1	.80	100/500
JDS183SS	92783	10	1 1/4	.87	100/500

OTHER SIZES AND QUANTITIES AVAILABLE BY REQUEST

CONTINUED ON NEXT PAGE  
[www.metallics.us](http://www.metallics.us)



CONTINUED  
**INDENTED HEX HEAD SLOTTED  
 TAPPING SCREWS**  
 STEEL ZINC • 18-8 STAINLESS



PART#	UPC#	DIAMETER	LENGTH	WT. PER PKG.	STD. PKG. UM
JDS184SS	81764	10	1½	1.02	100/500
JDS185SS	81765	10	2	1.33	100
JDS80SS	92680	10	2½	1.53	100
JDS81SS	92681	10	3	1.83	100
JDS186SS	92786	12	½	.75	100/500
JDS170SS	92770	12	¾	.89	100/500
JDS171SS	92771	12	1	1.04	100/500
JDS172SS	92772	12	1¼	1.17	100
JDS173SS	92773	12	1½	1.35	100/500
JDS174SS	92774	12	2	1.70	100/500
<b>3/8 HEAD</b>					
JDS176SS	72776	14	1	1.43	100/500
JDS177SS	92777	14	1¼	1.81	100
JDS178SS	92778	14	1½	2.22	100
JDS179SS	92779	14	2	2.69	100

OTHER SIZES AND QUANTITIES AVAILABLE BY REQUEST

Four drives in  
one head



**HEX HEAD QUADRIVE  
 TAPPING SCREWS**

*Indented Hex Washer, Slotted, Phillips, Square Recess Head*  
 STEEL ZINC

**First In The World**

*The Ideal Fastener For Light Gauge Sheet Metal*



Introduced in 1999

PART#	UPC#	DIAMETER	LENGTH	WT. PER PKG.	STD. PKG. UM
<b>1/4 HEAD</b>					
QDS152	39100	8	½	.39	100/500
QDS152V	39116	8	½	1.95	500
QDS153	39101	8	¾	.48	100/500
QDS153V	39117	8	¾	2.40	500
QDS154	39102	8	1	.59	100/500
QDS156	39103	10	¾	.55	100/500
QDS158	39104	10	1	.66	100/500
<b>5/16 HEAD</b>					
QDS181	39106	10	¾	.68	100/500
QDS181V	39119	10	¾	3.36	500
QDS182	39107	10	1	.82	100/500
QDS183	39108	10	1¼	.95	100/500
QDS184	39109	10	1½	1.09	100/500
QDS185	39110	10	2	1.36	100
QDS185V	39118	10	2	6.80	500
QDS80	39111	10	2½	1.62	100
QDS171	39112	12	1	.97	100/500
QDS172	39113	12	1¼	1.12	100/500
QDS174	39114	12	2	1.71	100

OTHER SIZES AND QUANTITIES AVAILABLE BY REQUEST





Phillips

PHILLIPS HEAD HEX TAPPING SCREWS  
STEEL ZINC

PART#	UPC#	DIAMETER	LENGTH	WT. PER PKG.	STD. PKG. UM
<b>STEEL ZINC</b>					
<b>1/4 HEAD</b>					
JDSP154	92055	8	1	.56	100
JDSP157	92057	8	1½	.75	100
<b>5/16 HEAD</b>					
JDSP180	92062	10	½	.55	100
JDSP181	92061	10	¾	.63	100
JDSP182	92063	10	1	.75	100
JDSP183	92064	10	1¼	.89	100
JDSP184	92065	10	1½	1.03	100
JDSP185	92066	10	2	1.30	100
JDSP80	92067	10	2½	1.53	100
JDSP81	92068	10	3	1.81	100
JDSP171	92071	12	1	1.02	100
JDSP173	92072	12	1½	1.32	100
JDSP174	92073	12	2	1.66	100
JDSP86	92075	12	2½	2.05	100
<b>3/8 HEAD</b>					
JDSP179	92080	14	2	2.45	100

OTHER SIZES AND QUANTITIES AVAILABLE BY REQUEST



Hex  
Slotted

HEX HEAD SLOTTED SHARP POINT  
SELF-PIERCING/TAPPING SCREWS  
STEEL ZINC

PART#	UPC#	DIAMETER	LENGTH	WT. PER PKG.	STD. PKG. UM
<b>STEEL ZINC</b>					
<b>1/4 HEAD</b>					
JQK1	80314	7	½	.32	100/500
JQK1V	97501	7	½	1.60	500
QK1M	10660	7	½	2.76	1000
QK1-5M	27865	7	½	13.80	5000
QK18M	78308	7	½	25.60	8000
JQK5	80315	8	½	.35	100/500
JQK5V	97505	8	½	1.75	500
QK5M	10661	8	½	3.02	1000
QK55M	78315	8	½	15.14	5000
QK510M	90221	8	½	29.52	10000
QK512M	78314	8	½	36.24	12000
QK515M	78321	8	½	49.87	15000
JQK10	80316	8	¾	.43	100/500
JQK10V	97510	8	¾	2.15	500
QK10M	10662	8	¾	3.86	1000
QK10B	77359	8	¾	38.80	10000
QK10-5M	53067	8	¾	19.30	5000
JQK15V	97515	8	1	2.70	500
QK15M	10663	8	1	4.95	1000
QK155M	78310	8	1	24.75	5000
QK158M	78311	8	1	43.20	8000
QK1510M	78312	8	1	54.00	10000
JQK15	80317	8	1	.54	100/500
JQK16	75816	8	1¼	.63	100/500
JQK16V	97516	8	1¼	3.10	500
QK16M	27890	8	1¼	6.03	1000

OTHER SIZES AND QUANTITIES AVAILABLE BY REQUEST



## HEX HEAD SLOTTED SHARP POINT SELF-PIERCING/TAPPING SCREWS

STEEL ZINC

A

PART#	UPC#	DIAMETER	LENGTH	WT. PER PKG.	STD. PKG. UM
<b>STEEL ZINC</b>					
<b>1/4 HEAD</b>					
QK168M	27886	8	1¼	47.06	8000
QK1610M	27877	8	1¼	60.30	10000
JQK17	80318	8	1½	.71	100/500
QK17CCL	78317	8	1½	1.78	250
JQK17V	97517	8	1½	3.55	500
QK17M	10664	8	1½	6.59	1000
QK175M	27617	8	1½	32.95	5000
QK178M	27905	8	1½	52.72	8000
QK1710M	27904	8	1½	65.90	10000
JQK19	80319	8	2	.88	100/500
QK19CCL	73819	8	2	2.20	250
JQK19V	97519	8	2	4.40	500
QK19M	10665	8	2	8.45	1000
JQK20	80320	10	½	.53	100/500
JQK20V	97520	10	½	2.65	500
QK20M	10666	10	½	3.53	1000
QK205M	78325	10	½	17.65	5000
JQK25	80321	10	¾	.51	100/500
JQK25V	97525	10	¾	2.55	500
QK25M	10667	10	¾	4.85	1000
QK254M5V	10773	10	¾	22.95	4500
QK258M	27925	10	¾	38.30	8000
JQK30	80322	10	1	.61	100/500
JQK30V	97525	10	1	2.99	500
QK30M	10668	10	1	7.10	1000
JQK21	75821	10	1¼	.82	100/500
JQK21CCL	69421	10	1¼	2.05	250
JQK21V	97521	10	1¼	4.10	500
JQK22	75822	10	1½	.87	100/500
JQK22V	80865	10	1½	4.22	500
JQK23	75823	10	2	1.25	100/500
JQK23V	80866	10	2	6.25	500
<b>5/16 HEAD</b>					
JQK59	75859	10	1	.71	100/500
JQK59V	75830	10	1	3.55	500
JQK60	75860	10	2	1.25	100/500
QK60M	51387	10	2	2.50	1000
JQK12114	85983	12	1¼	1.11	100/500

OTHER SIZES AND QUANTITIES AVAILABLE BY REQUEST

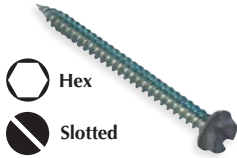

Hex  
Slotted

**GRAY HEX HEAD SLOTTED SHARP POINT  
SELF-PIERCING/TAPPING SCREWS**  
STEEL ZINC

PART#	UPC#	DIAMETER	LENGTH	WT. PER PKG.	STD. PKG. UM
<b>GRAY 1/4 HEAD</b>					
JQK15GR	50072	8	1	.54	100/500
JQK15GRV	50073	8	1	2.70	500
QK15GRM	27871	8	1	5.40	1000
QK15GR8M	27872	8	1	43.20	8000
QK15GR10M	27870	8	1	54.00	10000
JQK16GR	27880	8	1¼	.63	100/500
JQK16GRV	27881	8	1¼	3.10	500
QK16GRM	27888	8	1¼	6.08	1000
QK16GR8M	27889	8	1¼	45.57	8000
QK16GR-10M	27887	8	1¼	60.87	10000
JQK17GR	27897	8	1½	.71	100/500
JQK17GRV	27898	8	1½	3.55	500
QK17GRM	27908	8	1½	7.10	1000
QK17GR8M	27907	8	1½	56.80	8000
QK17GR10M	27906	8	1½	71.00	10000

OTHER SIZES AND QUANTITIES AVAILABLE BY REQUEST

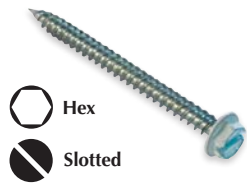

Hex  
Slotted

**WHITE HEX HEAD SLOTTED  
SHARP POINT SELF-PIERCING/  
TAPPING SCREWS**  
STEEL ZINC

PART#	UPC#	DIAMETER	LENGTH	WT. PER PKG.	STD. PKG. UM
<b>WHITE 1/4 HEAD</b>					
JQK15W	50074	8	1	.54	100/500
JQK15WV	50075	8	1	2.70	500
QK15WM	27875	8	1	5.40	1000
QK15W8M	27874	8	1	43.20	8000
QK15W10M	27873	8	1	54.00	10000
JQK16W	27884	8	1¼	.63	100/500
JQK16WV	27883	8	1¼	3.10	500
QK16WM	27894	8	1¼	6.08	1000
QK16W8M	27892	8	1¼	45.57	8000
QK16W-10M	27891	8	1¼	60.8	10000
JQK17W	27899	8	1½	.71	100/500
JQK17WV	27900	8	1½	3.55	500
QK17WM	27911	8	1½	7.10	1000
QK17W8M	27910	8	1½	56.80	8000
QK17W10M	27909	8	1½	71.00	10000
JQK19W	97522	8	2	.88	100/500
JQK19WCCL	97600	8	2	2.50	250
QK19WM	10686	8	2	8.90	1000

OTHER SIZES AND QUANTITIES AVAILABLE BY REQUEST



## PAN HEAD PHILLIPS SELF-DRILLING & TAPPING SCREWS

STEEL ZINC • 410 STAINLESS

A

PART#	UPC#	DIAMETER	LENGTH	WT. PER PKG.	STD. PKG. UM
<b>#2 DRILL POINT STEEL ZINC</b>					
JTEK34P	82294	6	3/8	.22	100/500
JTEK10P	80333	6	1/2	.25	100/500
JTEK10PV	97710	6	1/2	1.25	500
TEK10PB	62410	6	1/2	20.78	10000
JTEK11P	80334	6	3/4	.32	100/500
JTEK11PV	97711	6	3/4	1.41	500
JTEK12P	80335	6	1	.39	100/500
JTEK12PV	97712	6	1	1.95	500
JTEK13P	82276	6	1	.44	100/500
JTEK71P	84578	6	1 1/2	.53	100
JTEK1P	80336	8	1/2	.36	100/500
JTEK1PV	97701	8	1/2	1.65	500
TEK1P5M	74705	8	1/2	15.82	5000
TEK1P10M	74706	8	1/2	31.23	10000
JTEK2P	80337	8	3/4	.49	100/500
JTEK2PV	97702	8	3/4	2.45	500
JTEK16P	90080	8	5/8	.41	100/500
JTEK14P	80338	8	1	.55	100/500
JTEK14PV	97714	8	1	2.75	500
JTEK114P	77714	8	1 1/4	.61	100/500
JTEK15P	80339	8	1 1/2	.74	100/500
JTEK15PV	97715	8	1 1/2	3.70	500
JTEK82P	77682	8	2	.94	100/500
JTEK4P	80340	10	1/2	.51	100/500
JTEK4PV	97704	10	1/2	2.55	500
TEK4PM	94404	10	1/2	4.46	1000
JTEK3P	80341	10	3/4	.61	100/500
JTEK3PV	97703	10	3/4	3.05	500
JTEK7P	80342	10	1	.75	100/500
TEK7PB	11597	10	1	1.88	250
JTEK7PV	97707	10	1	3.75	500
JTEK18P	80343	10	1 1/4	.87	100/500
JTEK18PV	97718	10	1 1/4	4.35	500
JTEK19P	80344	10	1 1/2	.98	100/500
JTEK19PV	97719	10	1 1/2	4.90	500
JTEK20P	81311	10	2	1.23	100/500
<b>#3 DRILL POINT STEEL ZINC</b>					
JTEK8P	81313	10	5/8	.57	100
JTEK32P	82292	12	2	1.60	100
<b>#2 DRILL POINT 410 STAINLESS</b>					
JTEK10PSS	84560	6	1/2	.24	100/500
JTEK11PSS	84561	6	3/4	.31	100/500
JTEK12PSS	84562	6	1	.38	100
JTEK71PSS	84579	6	1 1/2	.53	100
JTEK1PSS	84563	8	1/2	.38	100/500
JTEK2PSS	84564	8	3/4	.46	100/500
JTEK14PSS	84565	8	1	.54	100/500
JTEK4PSS	84567	10	1/2	.47	100/500
JTEK3PSS	84553	10	3/4	.61	100/500
JTEK7PSS	84569	10	1	.72	100/500
JTEK19PSS	84571	10	1 1/2	1.03	100/500
JTEK20PSS	84572	10	2	1.22	100

OTHER SIZES AND QUANTITIES AVAILABLE BY REQUEST



HEX "HIGH HAT" WASHER HEAD  
SELF-DRILLING & TAPPING SCREWS

STEEL ZINC

For Maximum Drilling Engagement "Don't Slip When You Drive"



PART#	UPC#	DIAMETER	LENGTH	DRILL POINT	WT. PER PKG.	STD. PKG. UM
<b>5/16 HEAD #3 DRILL POINT</b>						
<b>100 PACK</b>						
JTEKDHH6	19728	10	¾	#3	.65	100
JTEKDHH7	19732	10	1	#3	.77	100
JTEKDHH19	19736	10	1½	#3	1.05	100
<b>1000 PACK</b>						
JTEKDHH6M	19729	10	¾	#3	6.50	1000
JTEKDHH7M	19733	10	1	#3	7.70	1000
JTEKDHH19M	19737	10	1½	#3	10.50	1000
<b>BULK PACK</b>						
TEKDHH65M	19730	10	¾	#3	32.50	5000
TEKDHH75M	19734	10	1	#3	38.50	5000
TEKDHH195M	19738	10	1½	#3	52.50	5000
TEKDHH6B	19731	10	¾	#3	65.00	10000
TEKDHH7B	19735	10	1	#3	77.00	10000
TEKDHH19B	19739	10	1½	#3	105.00	10000

OTHER SIZES AND QUANTITIES AVAILABLE BY REQUEST

- Hex
- Slotted
- Phillips
- Square Drive



HEX HEAD QUADRIVE SELF-DRILLING  
AND TAPPING SCREWS

FIRST IN THE WORLD  
DOMESTIC STEEL ZINC

Four drives in one head • Introduced in 1999



PART#	UPC#	DIAMETER	LENGTH	WT. PER PKG.	STD. PKG. UM
<b>1/4 HEAD #2 DRILL POINT</b>					
QTEKD1	39120	8	½	.38	100/500
QTEKD1V	98001	8	½	1.60	500
QTEKD2	39121	8	¾	.48	100/500
QTEKD2V	98002	8	¾	2.40	500
QTEKD14	39122	8	1	.58	100/500
QTEKD14V	98014	8	1	2.90	500
QTEKD4	39123	10	½	.41	100/500
QTEKD4V	98004	10	½	2.05	500
QTEKD3	39124	10	¾	.52	100/500
QTEKD3V	98003	10	¾	2.60	500
<b>5/16 HEAD #2 DRILL POINT</b>					
QTEKD5	39125	10	½	.54	100/500
QTEKD5V	98005	10	½	2.70	500
QTEKD5M	39141	10	½	5.80	1000
QTEKD17	39126	10	5/8	.59	100/500
QTEKD17V	98017	10	5/8	2.88	500
QTEKD17M	39133	10	5/8	5.40	1000
QTEKD6	39127	10	¾	.66	100/500
QTEKD6V	98006	10	¾	3.30	500
QTEKD6M	39142	10	¾	7.00	1000
QTEKD7	39128	10	1	.79	100/500
QTEKD7V	98007	10	1	3.95	500

OTHER SIZES AND QUANTITIES AVAILABLE BY REQUEST

-  Hex
-  Slotted
-  Phillips
-  Square Drive



CONTINUED  
**HEX HEAD QUADRIVE SELF-DRILLING  
 AND TAPPING SCREWS**

FIRST IN THE WORLD  
 DOMESTIC STEEL ZINC

*Four drives in one head • Introduced in 1999*



PART#	UPC#	DIAMETER	LENGTH	WT. PER PKG.	STD. PKG. UM
<b>5/16 HEAD #2 DRILL POINT</b>					
QTEKD7M	39143	10	1	8.70	1000
QTEKD18	39129	10	1¼	.91	100/500
QTEKD18V	98018	10	1¼	4.55	500
QTEKD18M	39134	10	1¼	9.90	1000
QTEKD19	39130	10	1½	1.05	100/500
QTEKD19V	98019	10	1½	5.25	500
QTEKD19M	39132	10	1½	11.40	1000
<b>5/16 HEAD #3 DRILL POINT</b>					
QTEKD12	39135	10	¾	.69	100/500
QTEKD12V	98012	10	¾	3.45	500
QTEKD13	39136	10	1	.81	100/500
QTEKD13V	98013	10	1	4.05	500
QTEKD20	39137	12	¾	.77	100/500
QTEKD20V	98020	12	¾	3.85	500
QTEKD8	39138	12	1	.95	100/500
QTEKD8V	98008	12	1	4.75	500

OTHER SIZES AND QUANTITIES AVAILABLE BY REQUEST

**HEX HEAD SELF-DRILLING/TAPPING SCREWS  
 INDENTED HEX WASHER**

STEEL ZINC • 410 STAINLESS



-  Hex

PART#	UPC#	DIAMETER	LENGTH	WT. PER PKG.	STD. PKG. UM
<b>STEEL ZINC</b>					
<b>1/4 HEAD #2 DRILL POINT</b>					
JTEKD26	83324	6	3/8	.28	100/500
JTEKD25	83323	6	½	.32	100/500
TEKD25B	62219	6	½	.32	10000
JTEKD63	35466	6	¾	.38	100/500
JTEKD27	83326	6	1	.44	100/500
JTEKD64	35467	6	1¼	.45	100/500
JTEKD65	35468	6	1½	.52	100/500
JTEKD66	35469	6	2	.56	100/500
JTEKD1	10800	8	½	.37	100/500
JTEKD1V	97801	8	½	1.69	500
TEKD175	11067	8	½	2.78	750
JTEKD1M	81450	8	½	3.22	1000
TEKD15M	33900	8	½	15.66	5000
JTEKD16	10831	8	5/8	.44	100/500
JTEKD16V	97816	8	5/8	1.42	500
TEKD16M	33016	8	5/8	3.84	1000
JTEKD2	10801	8	¾	.46	100/500
JTEKD2V	97802	8	¾	2.30	500
JTEKD2M	81452	8	¾	4.11	1000
TEKD25M	10795	8	¾	20.35	5000
TEKD210M	10796	8	¾	41.61	10000
JTEKD14	10802	8	1	.54	100/500
JTEKD14V	97814	8	1	2.70	500

OTHER SIZES AND QUANTITIES AVAILABLE BY REQUEST

CONTINUED

HEX HEAD SELF-DRILLING/TAPPING SCREWS  
INDENTED HEX WASHER

METRIC • STEEL ZINC • 410 STAINLESS • ALUMINUM



A

PART#	UPC#	DIAMETER	LENGTH	WT. PER PKG.	STD. PKG. UM
<b>STEEL ZINC</b>					
<b>1/4 HEAD #2 DRILL POINT</b>					
JTEKD114	10825	8	1¼	.36	50/250
JTEKD114V	90662	8	1¼	1.80	500
JTEKD15	10804	8	1½	.78	100/500
JTEKD15V	97815	8	1½	3.63	500
TEKD155M	19740	8	1½	36.30	5000
JTEKD82	83382	8	2	1.02	100/500
JTEKD88	35491	8	2½	1.15	100
JTEKD91AF	62691	9	1½	.81	100/500
JTEKD4	10806	10	½	.46	100/500
JTEKD4V	97804	10	½	2.30	500
JTEKD4M	81455	10	½	4.60	1000
JTEKD3	10807	10	¾	.54	100/500
JTEKD3V	97803	10	¾	2.70	500
JTEKD3M	81456	10	¾	5.40	1000
<b>5/16 HEAD #2 DRILL POINT</b>					
JTEKD5	10808	10	½	.52	100/500
JTEKD5V	97805	10	½	2.50	500
JTEKD5M	81457	10	½	5.00	1000
TEKD55M	28429	10	½	22.76	5000
JTEKD17	10830	10	5/8	.57	100/500
JTEKD17V	97817	10	5/8	2.85	500
JTEKD6	10809	10	¾	.64	100/500
JTEKD6V	10821	10	¾	3.06	500
TEKD675	11068	10	¾	4.76	750
JTEKD6M	33006	10	¾	6.05	1000
TEKD65M	33905	10	¾	29.78	5000
TEKD610M	33810	10	¾	59.10	10000
JTEKD7	10810	10	1	.76	100/500
JTEKD7V	10826	10	1	3.75	500
JTEKD7M	81460	10	1	7.50	1000
TEKD75M	10829	10	1	36.59	5000
JTEKD18	10832	10	1¼	.88	100/500
JTEKD18V	97818	10	1¼	4.45	500
JTEKD19	10833	10	1½	1.04	100/500
JTEKD19V	97819	10	1½	4.76	500
JTEKD24	83322	10	2½	1.57	100
JTEKD23	83321	10	3	1.86	100
JTEKD28	83327	12	½	.67	100/500
<b>5/16 HEAD #3 DRILL POINT</b>					
TEKD55B	11117	10	½	26.90	5000
JTEKD12	10811	10	¾	.62	100/500
JTEKD12V	97812	10	¾	3.10	500
TEK12M	39003	10	¾	6.20	1000
TEKD125M	33912	10	¾	29.65	5000
TEKD1210M	10797	10	¾	59.30	10000
JTEKD13	80359	10	1	.75	100/500
JTEKD13V	97813	10	1	3.75	500
TEK13M	39004	10	1	7.50	1000
TEKD135M	10798	10	1	37.50	5000

OTHER SIZES AND QUANTITIES AVAILABLE BY REQUEST

CONTINUED ON NEXT PAGE

www.metallics.us



CONTINUED

## HEX HEAD SELF-DRILLING/TAPPING SCREWS INDENTED HEX WASHER

METRIC • STEEL ZINC • 410 STAINLESS • ALUMINUM



PART#	UPC#	DIAMETER	LENGTH	WT. PER PKG.	STD. PKG. UM
<b>STEEL ZINC</b>					
<b>5/16 HEAD #3 DRILL POINT</b>					
TEKD1310M	10799	10	1	75.00	10000
JTEKD22	10854	10	2	1.28	100/500
JTEKD22V	97822	10	2	6.40	500
JTEKD20	10835	12	¾	.81	100/500
JTEKD20V	97820	12	¾	4.05	500
JTEKD20M	56087	12	¾	7.68	1000
TEKD20B	62214	12	¾	40.50	5000
JTEKD8	10817	12	1	1.00	100/500
JTEKD8V	97808	12	1	5.00	500
JTEKD8M	81467	12	1	10.00	1000
JTEKD35	83335	12	1¼	1.03	100/500
JTEKD94	19726	12	1½	1.05	100
JTEKD21	10837	12	1½	1.33	100/500
JTEKD21V	97821	12	1½	6.65	500
JTEKD32	10827	12	2	1.71	100
JTEKD32V	97832	12	2	8.55	500
JTEKD32M	53078	12	2	17.10	1000
<b>5/16 HEAD #2 DRILL POINT</b>					
JTEKD12212	90655	12	2½	2.07	100
JTEKD30	10836	12	3	2.29	100
JTEKD38	83339	5/16	¾	2.33	100
JTEKD41	83341	5/16	1¼	3.04	100
<b>5/16 HEAD #4 DRILL POINT - ALUMINUM</b>					
TEKD6AL-10M	92500	10	¾	24.09	1000
<b>5/16 HEAD #3 DRILL POINT</b>					
JTEKD31	83331	12	7/8	.88	100/500
<b>3/8 HEAD #3 DRILL POINT</b>					
JTEKD9	10822	14	¾	1.23	100/500
JTEKD9V	97809	14	¾	6.15	500
JTEKD9M	81470	14	¾	12.30	1000
TEKD95M	33909	14	¾	61.50	5000
JTEKD10	10823	14	1	1.41	100/500
JTEKD10V	97810	14	1	7.05	500
TEKD10M	39011	14	1	14.10	1000
TEKD105M	33910	14	1	70.50	5000
JTEKD37	83337	14	1¼	1.69	100/500
TEKD37M	33037	14	1¼	17.00	1000
JTEKD11	10824	14	1½	1.75	100/500
JTEKD11V	97811	14	1½	9.72	500
TEK11M	39012	14	1½	17.50	1000
JTEKD5163	79700	14	1½	5.87	100
JTEKD34	10015	14	2	2.44	100
JTEKD34V	97834	14	2	12.20	500
TEKD34M	61137	14	2	24.40	1000
JTEKD90	83390	14	2½	2.84	100
JTEKD36	83336	14	3	3.41	100
JTEKD99	83399	14	4	4.39	100
JTEKD146	83312	14	6	6.32	100
<b>#5 DRILL POINT</b>					
JTEKD143	83333	¼	3	3.35	100

OTHER SIZES AND QUANTITIES AVAILABLE BY REQUEST

CONTINUED

HEX HEAD SELF-DRILLING/TAPPING SCREWS  
INDENTED HEX WASHER

METRIC • STEEL ZINC • 410 STAINLESS • ALUMINUM



A

PART#	UPC#	DIAMETER	LENGTH	WT. PER PKG.	STD. PKG. UM
<b>410 STAINLESS</b>					
<b>1/4 HEAD #2 DRILL POINT</b>					
JTEKD1SS	10803	8	1/2	.38	100/500
JTEKD2SS	85213	8	3/4	.50	100/500
JTEKD14SS	10805	8	1	.57	100/500
JTEKD114SS	19723	8	1 1/4	.68	100
JTEKD15SS	10813	8	1 1/2	.78	100/500
<b>5/16 HEAD #2 DRILL POINT</b>					
JTEKD5SS	10815	10	1/2	.43	100/500
JTEKD6SS	85222	10	3/4	.63	100/500
<b>5/16 HEAD #3 DRILL POINT</b>					
JTEKD4SS	10814	10	1/2	.40	100/500
JTEKD12SS	85227	10	3/4	.64	100/500
JTEKD7SS	10816	10	1	.78	100/500
TEKD7SSM	11607	10	1	7.51	1000
JTEKD18SS	85244	10	1 1/4	.91	100/500
<b>410 STAINLESS STEEL</b>					
<b>5/16 HEAD #3 DRILL POINT</b>					
JTEKD19SS	85255	10	1 1/2	1.02	100/500
JTEKD8SS	85217	10	1 3/4	1.14	100/500
JTEKD22SS	85229	10	2	1.26	100/500
JTEKD27SS	85243	10	3	1.78	100
JTEKD20SS	85230	12	3/4	.85	100/500
JTEKD29SS	79629	12	1	1.00	100/500
JTEKD21SS	85231	12	1 1/2	1.34	100/500
JTEKD32SS	69326	12	2	1.70	100
JTEKD12212SS	69327	12	2 1/2	2.07	100
JTEKD30SS	69328	12	3	2.29	100
JTEKD37SS	83338	14	1 1/4	1.65	100
JTEKD92SS	79692	14	1 1/2	2.00	100/500
JTEKD93SS	79693	14	2	2.44	100
<b>3/8 HEAD #3 DRILL POINT</b>					
JTEKD9SS	85235	14	3/4	1.25	100/500
JTEKD10SS	85236	14	1	1.42	100/500
JTEKD23SS	85238	14	3	3.32	100
TEKD44SSB	61175	14	3 1/2	54.65	1425
<b>METRIC</b>					
JTEKDM416	19727	M4.2	16	.42	100

OTHER SIZES AND QUANTITIES AVAILABLE BY REQUEST



HEX HEAD METAL TO WOOD SCREWS

STEEL ZINC/ALL-WEATHER COATING

PART#	UPC#	DIAMETER	LENGTH	HEAD SIZE	WT. PER PKG.	STD. PKG. UM
<b>WITH BONDED WASHER</b>						
TGW9151	25735	9-15	1	1/4	.43	50/250
TGW9151M	72683	9-15	1	1/4	7.48	1000
TGW91515M	14297	9-15	1 1/2	1/4	9.55	1000
TGW12212	14290	12	2 1/2	1/4	2.03	100
<b>WITHOUT WASHER</b>						
TG9151	25740	9-15	1	1/4	.36	50/250

OTHER SIZES AND QUANTITIES AVAILABLE BY REQUEST

MADE IN USA



### HEX HEAD HEAVY DUTY DRILL SCREWS

Heavy Duty Steel-To-Steel Application Steel Zinc/All-Weather Coating



PART#	JAR UPC#	DIAMETER	LENGTH	DRILL POINT	WT. PER PKG.	STD. PKG. UM
<b>DOMESTIC</b>						
<b>5/16 HEAD #5 DRILL POINT CORROSION RESISTANT</b>						
TXV1278D	25816	12-24	1¼	#4	.98	100
TXV12114D	25817	12-24	1¼	#5	.78	50/250
TXV12112D	25818	12-24	1½	#5	.78	50
TXV12200D	25819	12-24	2	#5	.97	50
TXV143D	25826	¼-28	3	#5	1.70	50
TXV144D	25827	¼-28	4	#5	2.20	50
TXV145D	25828	¼-28	5	#5	2.60	50
TXV146D	25829	¼-28	6	#5	1.80	25
TXV148D	25831	¼-28	8	#5	2.33	25
<b>5/16 HEAD #5 DRILL POINT CORROSION RESISTANT</b>						
TXV1278	25729	12-24	7/8	#4	.98	100
TXV12114	25730	12-24	1¼	#5	.66	50/250
TXV12114B	62181	12-24	1¼	#5	31.00	2500
TXV12114VLB	20865	12-24	1¼	#5	5.00	450
TXV12112	25728	12-24	1½	#5	.78	50/250
TXV12112VLB	20864	12-24	1½	#5	5.00	320
TXV12200	25925	12-24	2	#5	.97	50
TXV12200VLB	20862	12-24	2	#5	5.00	265
TXV123	25731	12-24	3	#5	2.30	100
TXV14112	25786	14-10	1½	TYPE 17	.78	100
TXV143	25779	¼-20	3	#5	3.40	100
TXV14400	25780	¼-20	4	#5	4.43	100
TXV144	25781	¼-20	4	#5	2.20	50
TXV14400VLB	20863	¼-20	4	#5	5.00	114
TXV145	25782	¼-20	5	#5	2.60	50
TXV148	25784	¼-20	8	#5	2.00	25
<b>5/16 HEAD #5 DRILL POINT STEEL ZINC</b>						
TXV101Z	25778	10	1	#5	.77	100
TXV12114Z	25785	12	1¼	#5	1.08	100/500
TXV12114ZVLB	25788	12	1¼	#5	5.00	456
TXV123Z	25722	12	3	#5	2.31	100

OTHER SIZES AND QUANTITIES AVAILABLE BY REQUEST

### HEX HEAD BONDED SEALING WASHER SELF-DRILLING

STEEL ZINC/ALL-WEATHER COATING

Economical fasteners for applications requiring a weather-tight seal



PART#	UPC#	DIAMETER	LENGTH	DRILL POINT	WT. PER PKG.	STD. PKG. UM
<b>5/16 HEAD #5 Drill Point Corrosion Resistant</b>						
TXW1034	25811	10-16	¾	#3	.41	100
TXW10112	25809	10-16	1½	#3	.79	100
TXW1234	25765	12-14	¾	#3	.62	50
TXW12114	25806	12-14	1¼	#3	.84	100
TXW12112	25804	12-14	1½	#3	.92	100
TXW121	25807	12-14	1	#3	1.32	100
TXW122	25803	12-14	2	#3	2.06	100
TXW123	25802	12-14	3	#3	2.81	100

OTHER SIZES AND QUANTITIES AVAILABLE BY REQUEST

A



Hex

CONTINUED  
**HEX HEAD BONDED  
 SEALING WASHER SELF-DRILLING**

STEEL ZINC/ALL-WEATHER COATING

*Economical fasteners for applications requiring a weather-tight seal*

PART#	UPC#	DIAMETER	LENGTH	DRILL POINT	WT. PER PKG.	STD. PKG. UM
<b>5/16 HEAD #5 Drill Point Corrosion Resistant</b>						
TXW1278	25808	12-24	7/8	#4	1.27	100
TXW1224112	25799	12-24	1 1/2	#5	1.64	100
TXW1478	25770	1/4-14	7/8	#1	.69	50
TXW1434	25798	1/4-14	3/4	#3	1.72	100
TXW141	25796	1/4-14	1	#3	1.86	100
TXW14114	25795	1/4-14	1 1/4	#3	2.07	100
TXW14112	25794	1/4-14	1 1/2	#3	2.31	100
TXW142	25793	1/4-14	2	#3	2.89	100
<b>WITH BONDED WASHERS</b>						
TXW1234	25765	12-14	3/4	#3	.62	50/250
TXW1224114	25791	12-24	1 1/4	#5	1.45	100/500
TXW1478	25770	1/4-14	7/8	#1	.69	50/250
<b>WITH NEO-EPDM WASHER No. 3 POINT STEEL ZINC</b>						
TXW1478	25770	1/4-14	7/8	#3	.69	50
TXW141	83704	1/4-14	1	#3	1.86	100
JTXW381Z	83706	3/8-12	1	#3	2.38	50

OTHER SIZES AND QUANTITIES AVAILABLE BY REQUEST



Hex

**HEX HEAD METAL TO METAL  
 SELF-DRILLING SCREWS**

STEEL ZINC/ALL-WEATHER COATING

*Fasteners for attaching standing roof clips and wall/roof metal panels to steel framing (purlin/bar joist).*

PART#	UPC#	DIAMETER	LENGTH	SIZE/ HEAD STYLE	DRILL POINT	WT. PER PKG.	STD. PKG. UM
<b>WITHOUT WASHER</b>							
TX103HL17	25725	10	3	5/16 Hex	Type 17	.98	50
TX1234	25755	12-14	3/4	5/16 Hex	#3	.44	50/250
TX1478	25760	1/4-14	7/8	3/8 Hex	#1	.54	50/250
TX1478M	25761	1/4-14	7/8	3/8 Hex	#1	10.39	1000
<b>410 STAINLESS STEEL WITH BONDED WASHER</b>							
TX121SS	25747	12-14	1	5/16 Hex	#3	1.22	100
TX12114SS	25775	12-14	1 1/4	5/16 Hex	#3	.81	50/250
TX12114SSB	25732	12-14	1 1/4	5/16 Hex	#3	4.05	250

OTHER SIZES AND QUANTITIES AVAILABLE BY REQUEST



Slotted

**FLAT HEAD SLOTTED WOOD SCREWS**

STEEL ZINC

PART#	UPC#	DIAMETER	LENGTH	WT. PER PKG.	STD. PKG. UM
JFW120	81934	4	1/2	.16	100
JFW19	85919	4	5/8	.21	100/500
JFW121	81935	4	3/4	.23	100/500
JFW122	81936	4	1	.25	100/500
JFW123	81937	4	1 1/4	.30	100/500
JFW20	85920	5	5/8	.22	100/500
JFW125	81939	5	3/4	.25	100/500
JFW126	81940	5	1	.30	100/500
JFW127	81941	5	1 1/4	.40	100/500

OTHER SIZES AND QUANTITIES AVAILABLE BY REQUEST

CONTINUED ON NEXT PAGE  
[www.metallics.us](http://www.metallics.us)



Slotted

CONTINUED  
**FLAT HEAD SLOTTED WOOD SCREWS**  
 STEEL ZINC

PART#	UPC#	DIAMETER	LENGTH	WT. PER PKG.	STD. PKG. UM
JFW128	81942	6	½	.26	100/500
JFW129	81943	6	¾	.28	100/500
JFW130	81944	6	1	.37	100/500
JFW49	85349	6	1¼	.46	100/500
JFW56	85356	6	1½	.27	100/500
JFW131	81945	8	¾	.40	100/500
JFW132	81946	8	1	.49	100/500
JFW133	81947	8	1¼	.68	100/500
JFW134	81948	8	1½	.76	100/500
JFW85	87385	8	2½	1.24	100/500
JFW136	81950	10	1	.66	100/500
JFW138	81952	10	1½	.90	100/500
JFW139	81816	10	2	1.16	100
JFW80	87380	10	2¼	1.48	100
JFW92	84380	10	2¾	1.80	100
JFW140	81954	12	1½	1.29	100
JFW89	87389	14	2½	2.61	100

OTHER SIZES AND QUANTITIES AVAILABLE BY REQUEST



Phillips

**FLAT HEAD PHILLIPS WOOD SCREWS**  
 STEEL ZINC

PART#	UPC#	DIAMETER	LENGTH	WT. PER PKG.	STD. PKG. UM
JFWP120	88120	4	½	.11	100/500
JFWP61	84661	4	¾	.20	100/500
JFWP62	84662	4	1	.24	100/500
JFWP08	81849	5	½	.18	100/500
JFWP69	84669	5	¾	.25	100/500
JFW126	81940	5	1	.30	100/500
JFWP09	81850	5	1	.31	100/500
JFWP9	84609	6	½	.27	100/500
JFW129	81943	6	¾	.28	100/500
JFWP10	80369	6	¾	.28	100/500
JFWP10M	81852	6	¾	2.53	1000
JFWP11	80370	6	1	.35	100/500
JFWP11M	81857	6	1	3.50	1000
JFWP12	81853	6	1¼	.43	100/500
JFWP13	84613	6	1½	.49	100/500
JFWP14	81855	6	2	.64	100/500
JFWP17	84617	8	½	.31	100/500
JFWP18	80371	8	¾	.34	100/500
JFWP19	80372	8	1	.48	100/500
JFWP20	80373	8	1¼	.61	100/500
JFWP21	80374	8	1½	.67	100/500
JFWP65	84665	8	1¾	.69	100/500
JFWP22	80375	8	2	.84	100/500
JFWP22M	81859	8	2	8.45	1000
JFWP23	84623	8	2½	1.05	100/500
JFWP24	80376	8	3	1.34	100
JFWP25	84625	8	3½	1.68	100
JFWP15	81856	8	4	1.94	100
JFWP27	84627	10	½	.40	100/500
JFWP28	80377	10	¾	.53	100/500
JFWP29	80378	10	1	.67	100/500

OTHER SIZES AND QUANTITIES AVAILABLE BY REQUEST

CONTINUED ON NEXT PAGE  
[www.metallics.us](http://www.metallics.us)



CONTINUED  
**FLAT HEAD PHILLIPS WOOD SCREWS**  
 STEEL ZINC

A

PART#	UPC#	DIAMETER	LENGTH	WT. PER PKG.	STD. PKG. UM
JFWP30	80379	10	1¼	.72	100/500
JFWP31	80380	10	1½	.99	100/500
JFWP67	84667	10	1¾	1.12	100/500
JFWP32	80381	10	2	1.12	100/500
JFWP33	80382	10	2½	1.59	100
JFWP34	84634	10	3	1.63	100
JFWP35	84635	10	3½	2.33	100
JFWP36	84636	10	4	2.51	100
JFWP39	84639	12	1	.91	100/500
JFWP40	80383	12	1¼	.96	100/500
JFWP41	80384	12	1½	1.30	100/500
JFWP42	80385	12	2	1.45	100/500
JFWP43	80386	12	2½	1.74	100
JFWP43V	11043	12	2½	8.70	500
JFWP44	84644	12	3	2.07	100
JFWP45	84645	12	3½	2.89	100
JFWP46	84646	12	4	3.68	100
JFWP49	84649	14	1½	1.67	100/500
JFWP47	84647	14	1¾	1.77	100/500
JFWP48	84648	14	2	2.05	100
JFWP89	84689	14	2½	2.28	100
JFWP50	84650	14	3	3.07	100

OTHER SIZES AND QUANTITIES AVAILABLE BY REQUEST



**FLAT HEAD PHILLIPS WOOD SCREW**  
 18-8 STAINLESS

PART#	UPC#	DIAMETER	LENGTH	WT. PER PKG.	STD. PKG. UM
JFWP9SS	92209	6	½	.27	100
JFWP10SS	92210	6	¾	.28	100
JFWP11SS	92211	6	1	.35	100
JFWP12SS	92212	6	1¼	.48	100
JFWP13SS	92213	6	1½	.49	100
JFWP14SS	92214	6	2	.55	100
JFWP18SS	92218	8	¾	.40	100
JFWP19SS	92219	8	1	.50	100
JFWP20SS	92220	8	1¼	.61	100
JFWP21SS	92221	8	1½	.67	100
JFWP65SS	92315	8	1¾	.69	100
JFWP22SS	92222	8	2	.84	100
JFWP23SS	92223	8	2½	1.05	100
JFWP24SS	92224	8	3	1.34	100
JFWP28SS	92228	10	¾	.53	100
JFWP29SS	92229	10	1	.67	100
JFWP30SS	92230	10	1¼	.72	100
JFWP31SS	92231	10	1½	1.04	100
JFWP67SS	92317	10	1¾	1.12	100
JFWP32SS	92232	10	2	1.12	100
JFWP33SS	92233	10	2½	1.59	100
JFWP34SS	92234	10	3	1.63	100
JFWP35SS	92235	10	3½	1.85	100
JFWP39SS	92239	12	1	0.91	100
JFWP40SS	92240	12	1¼	1.20	100
JFWP41SS	92241	12	1½	1.30	100
JFWP42SS	92242	12	2	1.45	100
JFWP43SS	92243	12	2½	1.74	100
JFWP44SS	92244	12	3	2.40	100

OTHER SIZES AND QUANTITIES AVAILABLE BY REQUEST



## FLAT HEAD PHILLIPS WOOD SCREW

BRASS

PART#	UPC#	DIAMETER	LENGTH	WT. PER PKG.	STD. PKG. UM
JFWPB45	73145	4	½	.17	100
JFWPB61	73161	4	¾	.21	100
JFWPB62	73162	4	1	.27	100
JFWPB63	73163	4	1¼	.32	100
JFWPB64	73164	4	1½	.37	100
JFWPB04	73086	6	¾	.26	100
JFWPB89	20953	6	½	.24	100
JFWPB05	73087	6	5/8	.28	100
JFWPB10	73110	6	¾	.28	100
JFWPB11	73111	6	1	.35	100
JFWPB12	73112	6	1¼	.61	100
JFWPB13	73113	6	1½	.67	100
JFWPB06	73088	6	1¾	.68	100
JFWPB14	73114	6	2	.84	100
JFWPB15	73115	6	2½	1.05	100
JFWPB16	73116	6	3	1.34	100
JFWPB07	73089	8	5/8	.33	100
JFWPB17	73117	8	½	.30	100
JFWPB18	73118	8	¾	.34	100
JFWPB08	73090	8	7/8	.36	100
JFWPB19	73119	8	1	.48	100
JFWPB20	73120	8	1¼	.61	100
JFWPB21	73121	8	1½	.75	100
JFWPB09	73091	8	1¾	.77	100
JFWPB22	73122	8	2	.91	100
JFWPB23	73123	8	2½	1.05	100
JFWPB24	73124	8	3	1.34	100
JFWPB27	73127	10	½	.50	100
JFWPB51	73092	10	5/8	.43	100
JFWPB28	73128	10	¾	.53	100
JFWPB29	73129	10	1	.67	100
JFWPB30	73130	10	1¼	.72	100
JFWPB31	73131	10	1½	.89	100
JFWPB32	73132	10	2	1.12	100
JFWPB33	73133	10	2½	1.59	100
JFWPB34	73134	10	3	1.82	100
JFWPB38	73138	12	¾	.78	100
JFWPB39	73139	12	1	.91	100
JFWPB40	73140	12	1¼	.96	100
JFWPB41	73141	12	1½	1.30	100
JFWPB52	73093	12	1¾	1.36	100
JFWPB42	73142	12	2	1.45	100
JFWPB43	73143	12	2½	1.59	100
JFWPB44	73144	12	3	2.99	100

OTHER SIZES AND QUANTITIES AVAILABLE BY REQUEST

## STAR DRIVE ROUND WASHER HEAD RUGGED STRUCTURAL WOOD SCREW

T-30 305 STAINLESS STEEL RSS™

For anywhere you would use a traditional lag screw and more.



PART#	UPC#	SIZE	WT. PER PKG.	STD. PKG. UM
MGRK4SS	19691	5/16 X 4	1.94	100





**BUGLE HEAD PHILLIPS COARSE THREAD DRYWALL SCREWS**

STEEL BLACK PHOSPHATE • GALVANIZED



PART#	UPC#	DIAMETER	LENGTH	WT. PER PKG.	STD. PKG. UM
<b>100 PACK</b>					
JDWC1C	90501	6	1	.35	100/500
JDWC3C	90503	6	1¼	.43	100/500
JDWC4C	90504	6	1 <sup>5</sup> / <sub>8</sub>	.51	100/500
JDWC5C	90505	6	2	.60	100/500
JDWC6C	90506	6	2¼	.70	100/500
JDWC101C	90519	8	2	.70	100
JDWC7C	90507	8	2½	1.00	100/500
JDWC9C	90509	8	3	1.12	100/500
JDWC11C	90511	10	4	2.12	100
JDWC13C	74013	10	5	2.48	100
<b>500 PACK</b>					
JDWC3V	90513	6	1¼	2.15	500
DWC4V	91464	6	1 <sup>5</sup> / <sub>8</sub>	2.38	500
<b>1000 PACK IN SQUARE PLASTIC JAR — 1 Power Bit included FREE in 1000 Pack</b>					
DWC1M	90331	6	1	3.03	1000
DWC3M	90333	6	1¼	3.74	1000
DWC4M	90334	6	1 <sup>5</sup> / <sub>8</sub>	4.84	1000
DWC5M	90335	6	2	5.63	1000
DWC9M	90339	8	3	10.80	1000
<b>BULK PACK IN CARTON — 3 Power Bits included FREE in Bulk Pack</b>					
DWC3B	83308	6	1¼	29.99	8000
DWC4B	83309	6	1 <sup>5</sup> / <sub>8</sub>	23.40	5000
DWC5B	83515	6	2	19.29	3500
DWC6B	83516	6	2¼	18.57	3000
DWC7B	83517	8	2½	22.98	2500
DWC75B	15556	8	2½	50.00	5000
DWC9B	83519	8	3	22.25	2000
DWC10B	83520	10	3½	27.05	1500

OTHER SIZES AND QUANTITIES AVAILABLE BY REQUEST



**BUGLE HEAD PHILLIPS FINE  
THREAD DRYWALL SCREWS**

DOMESTIC STEEL BLACK PHOSPHATE



PART#	UPC#	DIAMETER	LENGTH	WT. PER PKG.	STD. PKG. UM
JDWS3CD	76503	6	1¼	.46	100
JDWS4CD	76504	6	1 <sup>5</sup> / <sub>8</sub>	.56	100
JDWS5CD	76505	6	2	.71	100
JDWS2MD	61148	6	1 <sup>1</sup> / <sub>8</sub>	3.80	1000
DWS3MD	76843	6	1¼	3.75	1000
DWS4MD	76844	6	1 <sup>5</sup> / <sub>8</sub>	4.75	1000
DWS5MD	76845	6	2	5.52	1000
DWS4BD	27119	6	1 <sup>5</sup> / <sub>8</sub>	13.42	2551
DWS5BD	27118	6	2	11.13	2015



## BUGLE HEAD PHILLIPS FINE THREAD DRYWALL SCREWS

STEEL BLACK PHOSPHATE



PART#	UPC#	DIAMETER	LENGTH	WT. PER PKG.	STD. PKG. UM
<b>100 PACK</b>					
JDWS75C	75975	6	¾	.31	100/500
JDWS1C	80387	6	1	.37	100/500
JDWS3C	80388	6	1¼	.41	100/500
JDWS4C	80389	6	1 <sup>5</sup> / <sub>8</sub>	.50	100/500
JDWS5C	80390	6	2	.56	100/500
JDWS6C	80391	6	2¼	.69	100/500
JDWS7C	80392	8	2½	.98	100/500
JDWS9C	80393	8	3	1.16	100
JDWS10C	84099	10	3½	1.86	100
<b>500 PACK</b>					
DWS1V	27115	6	1	1.83	500
DWS3V	27043	6	1¼	1.93	500
JDWS4V	76854	6	1 <sup>5</sup> / <sub>8</sub>	5.03	500
DWS5V	27045	6	2	2.87	500
DWS9V	27049	8	3	5.43	500
<b>1000 PACK IN SQUARE PLASTIC JAR – #2 DRIVE POWER BIT INCLUDED FREE IN 1000 PACK – SAVE OVER 100 PACK</b>					
DWS1M	27001	6	1	3.65	1000
DWS3M	27007	6	1¼	3.75	1000
DWS4M	27010	6	1 <sup>5</sup> / <sub>8</sub>	4.70	1000
DWS5M	27013	6	2	5.52	1000
DWS6M	27016	6	2¼	6.40	1000
DWS7M	27019	8	2½	6.43	1000
DWS9M	27025	8	3	10.55	1000
<b>BULK PACK IN CARTON – THREE #2 DRIVE POWER BITS INCLUDED FREE IN BULK PACK – SAVE OVER 100 PACK</b>					
DWS1B	27002	6	1	36.50	10000
DWS3B	27008	6	1¼	32.80	8000
DWS4B	27011	6	1 <sup>5</sup> / <sub>8</sub>	23.40	5000
DWS5B	27014	6	2	21.35	3500
DWS55B	15530	6	2	26.15	5000
DWS6B	27017	6	2¼	24.00	3000
DWS7B	27020	8	2½	27.00	2500
DWS75B	15535	8	2½	45.60	5000
DWS9B	27026	8	3	26.00	2000
DWS93B	15543	8	3	29.00	3000
DWS10B	10695	10	3½	19.50	10000
DWS11B	27311	10	5	13.89	200

OTHER SIZES AND QUANTITIES AVAILABLE BY REQUEST



## BUGLE HEAD SQUARE DRIVE DRYWALL SCREW COARSE THREAD

STEEL BLACK PHOSPHATE



PART#	UPC#	DIAMETER	LENGTH	WT. PER PKG.	STD. PKG. UM
JDWSR1C	80394	6	1	.35	100
JDWSR3C	80395	6	1¼	.41	100
JDWSR4C	80396	6	1 <sup>5</sup> / <sub>8</sub>	.52	100
JDWSR5C	80397	6	2	.60	100
JDWSR6C	80398	6	2¼	.60	100
JDWSR2C	82422	8	1	.41	100
JDWSR7C	80399	8	2½	.95	100
JDWSR9C	80400	8	3	1.19	100

OTHER SIZES AND QUANTITIES AVAILABLE BY REQUEST

CONTINUED

**BUGLE HEAD SQUARE DRIVE  
DRYWALL SCREW COARSE THREAD**

STEEL BLACK PHOSPHATE



Square Drive

PART#	UPC#	DIAMETER	LENGTH	WT. PER PKG.	STD. PKG. UM
DWSR1M	26066	6	1	3.47	1000
DWSR3M	26069	6	1¼	3.67	1000
DWSR4M	26072	6	1 <sup>5</sup> / <sub>8</sub>	5.20	1000
DWSR5M	26075	6	2	5.59	1000
DWSR6M	26078	6	2¼	8.00	1000
DWSR7M	26081	8	2½	9.35	1000
DWSR9M	26084	8	3	13.00	1000
DWSR1B	26067	6	1	35.00	10000
DWSR3B	26070	6	1¼	32.80	8000
DWSR4B	26073	6	1 <sup>5</sup> / <sub>8</sub>	26.00	5000
DWSR5B	26076	6	2	25.90	3500
DWSR6B	26079	6	2¼	24.00	3000
DWSR7B	26082	8	2½	27.00	2500
DWSR9B	26085	8	3	26.00	2000

OTHER SIZES AND QUANTITIES AVAILABLE BY REQUEST

**BUGLE HEAD PHILLIPS FINE THREAD SELF-DRILLING/TAPPING  
DRYWALL SCREWS**

STEEL ZINC



Phillips

PART#	UPC#	DIAMETER	LENGTH	WT. PER PKG.	STD. PKG. UM
<b>100 PACK</b>					
JSDS1C	80405	6	1	.39	100/500
JSDS3C	80406	6	1¼	.43	100/500
JSDS4C	80407	6	1 <sup>5</sup> / <sub>8</sub>	.53	100/500
JSDS5C	80408	6	1 <sup>7</sup> / <sub>8</sub>	.61	100/500
JSDS6C	83101	7	2	.65	100/500
JSDS7C	80409	8	2 <sup>5</sup> / <sub>8</sub>	1.10	100
JSDS9C	80410	8	3	1.24	100
<b>1000 PACK IN SQUARE PLASTIC JAR – POWER BIT INCLUDED FREE IN 1000 PACK</b>					
SDS1M	27051	6	1	3.45	1000
SDS3M	27057	6	1¼	4.04	1000
SDS4M	27060	6	1 <sup>5</sup> / <sub>8</sub>	5.25	1000
SDS5M	27063	6	1 <sup>7</sup> / <sub>8</sub>	7.00	1000
SDS7M	27069	8	2 <sup>5</sup> / <sub>8</sub>	10.49	1000
SDS9M	27075	8	3	12.07	1000
<b>BULK PACK IN BOX CARTON – 3 POWER BITS INCLUDED FREE IN BULK PACK</b>					
SDS1B	27052	6	1	39.00	10000
SDS3B	27058	6	1¼	36.80	8000
SDS4B	27061	6	1 <sup>5</sup> / <sub>8</sub>	29.00	5000
SDS5B	27064	6	1 <sup>7</sup> / <sub>8</sub>	28.00	4000
SDS7B	27070	8	2 <sup>5</sup> / <sub>8</sub>	23.00	2000
SDS8B	27073	8	2 <sup>3</sup> / <sub>8</sub>	29.33	3000
SDS9B	27076	8	3	18.45	1500

OTHER SIZES AND QUANTITIES AVAILABLE BY REQUEST



## FLAT HEAD PHILLIPS COARSE THREAD DECK SCREWS

STEEL YELLOW ZINC

A

PART#	UPC#	DIAMETER	LENGTH	WT. PER PKG.	STD. PKG. UM
<b>100 PACK – BIT NOT INCLUDED</b>					
JGDS0	81679	6	1	.35	100/500
JGDS1	81680	6	1¼	.42	100/500
JGDS2	81681	6	1 <sup>5</sup> / <sub>8</sub>	.51	100/500
JGDS3	81682	6	2	.61	100/500
JGDS4	81683	8	2½	.96	100
JGDS5	81684	8	3	1.16	100
JGDS6	81685	10	3½	1.88	100
JGDS7	81686	10	4	2.16	100
<b>500 PACK – 1 POWER BIT INCLUDED FREE IN 500 PACK SAVE</b>					
JGDS1V	80417	6	1¼	1.97	500
JGDS2V	80418	6	1 <sup>5</sup> / <sub>8</sub>	2.40	500
JGDS3V	80419	6	2	2.99	500
JGDS4V	80420	8	2½	4.68	500
JGDS5V	80421	8	3	5.62	500
GDS6V	12725	10	3½	9.09	500
GDS7V	12726	10	4	12.50	500
<b>1000 PACK – 1 POWER BIT INCLUDED FREE IN 1000 PACK SAVE</b>					
JGDS1M	82730	6	1¼	3.74	1000
JGDS2M	82731	6	1 <sup>5</sup> / <sub>8</sub>	4.70	1000
JGDS3M	82732	6	2	6.10	1000
GDS4M	12733	8	2½	10.42	1000
GDS5M	12734	8	3	11.13	1000
GDS6M	12735	10	3½	18.18	1000
GDS7M	12736	10	4	25.00	1000
<b>BULK PACK</b>					
GDS25B	54065	6	1 <sup>5</sup> / <sub>8</sub>	25.50	5000
GDS55B	54070	8	3	29.00	5000

OTHER SIZES AND QUANTITIES AVAILABLE BY REQUEST



## WAFFER HEAD PHILLIPS SHARP POINT SELF-PIERCING/TAPPING DRYWALL SCREWS

STEEL ZINC

PART#	UPC#	DIAMETER	LENGTH	WT. PER PKG.	STD. PKG. UM
<b>100 PACK</b>					
JWDW1C	80411	8	½	.36	100/500
JWDW2C	80412	8	¾	.43	100/500
JWDW3C	80413	8	1	.59	100/500
JWDW4C	81039	8	1¼	.68	100/500
<b>500 PACK</b>					
JWDW1V	74401	8	½	1.57	500
<b>1000 PACK IN VISUAL PLASTIC JAR – POWER BIT INCLUDED FREE IN 1000 PACK</b>					
WDW1M	27034	8	½	3.91	1000
WDW2M	27091	8	¾	4.77	1000
WDW3M	27092	8	1	5.59	1000
WDW4M	27089	8	1¼	6.22	1000
<b>BULK PACK IN BOX CARTON – 3 POWER BITS INCLUDED FREE IN BULK PACK</b>					
WDW1B	62163	8	½	36.95	10000
WDW2B	27093	8	¾	45.98	10000
WDW3B	27094	8	1	59.00	10000
WDW45B	54035	8	1¼	34.00	5000
WDW4B	27099	8	1¼	69.85	10000

OTHER SIZES AND QUANTITIES AVAILABLE BY REQUEST



**WAFER HEAD PHILLIPS SELF-DRILLING/  
TAPPING DRYWALL SCREWS**  
STEEL ZINC

PART#	UPC#	DIAMETER	LENGTH	WT. PER PKG.	STD. PKG. UM
<b>100 PACK</b>					
JWDS1C	80414	8	½	.38	100/500
JWDS2C	80415	8	¾	.56	100/500
JWDS3C	82043	8	1	.62	100/500
JWDS4C	80416	8	1¼	.70	100/500
JWDS6C	82046	8	1 <sup>5</sup> / <sub>8</sub>	.87	100
<b>500 PACK</b>					
JWDS1V	77194	8	½	1.66	500
JWDS4V	40004	8	1¼	3.50	500
<b>1000 PACK IN VISUAL PLASTIC JAR – POWER BIT INCLUDED FREE IN 1000 PACK</b>					
WDS1M	27084	8	½	3.27	1000
WDS2M	27095	8	¾	4.85	1000
WDS3M	27040	8	1	7.90	1000
WDS4M	27098	8	1¼	6.73	1000
WDS6M	82052	8	1 <sup>5</sup> / <sub>8</sub>	8.70	1000
<b>BULK PACK IN BOX CARTON – 3 POWER BITS INCLUDED FREE IN BULK PACK</b>					
WDS15B	27102	8	½	17.10	5000
WDS1B	27085	8	½	33.25	10000
WDS2B	27096	8	¾	55.00	10000
WDS3B	27104	8	1	79.00	10000
WDS45B	54042	8	1¼	35.00	5000
WDS4B	27097	8	1¼	87.10	10000

OTHER SIZES AND QUANTITIES AVAILABLE BY REQUEST



**PAN HEAD PHILLIPS SHARP POINT  
SELF-PIERCING FRAMING SCREWS**  
STEEL BLACK PHOSPHATE



PART#	UPC#	DIAMETER	LENGTH	WT. PER PKG.	STD. PKG. UM
JPDW1C	80401	6	7/16	.30	100
<b>1000 PACK IN SQUARE PLASTIC JAR – POWER BIT INCLUDED FREE IN 1000 PACK</b>					
PDW1M	27031	6	7/16	2.68	1000
<b>BULK PACK IN BOX CARTON – 3 POWER BITS INCLUDED FREE IN BULK PACK</b>					
PDW1B	27032	6	7/16	39.75	15000

OTHER SIZES AND QUANTITIES AVAILABLE BY REQUEST



**PAN HEAD PHILLIPS SELF-DRILLING/  
TAPPING FRAMING SCREWS**  
STEEL BLACK PHOSPHATE



PART#	UPC#	DIAMETER	LENGTH	WT. PER PKG.	STD. PKG. UM
JPDS1C	80403	6	7/16	.33	100/500
JPDS1V	82689	6	7/16	1.32	500
<b>1000 PACK IN SQUARE PLASTIC JAR – POWER BIT INCLUDED FREE IN 1000 PACK</b>					
PDS1M	27081	6	7/16	2.82	1000
<b>BULK PACK – 3 POWER BITS INCLUDED FREE IN BULK PACK</b>					
PDS1B	27082	6	7/16	42.30	15000

OTHER SIZES AND QUANTITIES AVAILABLE BY REQUEST



Square Drive

## BUGLE HEAD SQUARE DRIVE TYPE 17 COARSE THREAD DECK SCREWS

STEEL ZINC/ALL-WEATHER COATING • 316 STAINLESS

PART#	UPC#	DIAMETER	LENGTH	WT. PER PKG.	STD. PKG. UM
<b>100 PACK</b>					
JRDS1	81727	8	1¼	.50	100
JRDS2	81728	8	1 <sup>5</sup> / <sub>8</sub>	.74	100
JRDS3	81729	9	2	.81	100
JRDS4	81737	9	2½	1.23	100
JRDS5	81738	9	3	1.41	100
JRDS6	81739	10	4	2.50	100
<b>500 PACK – 1 POWER BIT INCLUDED FREE IN 500 PACK</b>					
JRDS1V	81740	8	1¼	2.28	500
JRDS2V	81741	8	1 <sup>5</sup> / <sub>8</sub>	3.62	500
JRDS3V	81742	9	2	4.94	500
JRDS4V	81743	9	2½	6.15	500
RDS5V	12744	9	3	6.02	500
RDS6V	12745	10	4	9.09	500
<b>1000 PACK – 1 POWER BIT INCLUDED FREE IN 1000 PACK</b>					
JRDS1M	81750	8	1¼	4.55	1000
JRDS2M	81751	8	1 <sup>5</sup> / <sub>8</sub>	4.81	1000
RDS3M	12752	9	2	6.29	1000
RDS4M	12753	9	2½	10.42	1000
RDS5M	12754	9	3	13.95	1000
RDS6M	12755	10	4	18.18	1000
<b>316 STAINLESS</b>					
RDS7M316SS	71747	8	2	7.80	1000

OTHER SIZES AND QUANTITIES AVAILABLE BY REQUEST



Phillips

## BUGLE HEAD SQUARE/PHILLIPS TYPE 17 COARSE THREAD DECK SCREWS

STEEL CERAMIC COATED

PART#	UPC#	DIAMETER	LENGTH	WT. PER PKG.	STD. PKG. UM
<b>100 PACK</b>					
JCPD1	77007	8	1 <sup>5</sup> / <sub>8</sub>	.68	100
JCPD2	77009	8	2	.89	100
JCPD3	77010	9	2½	1.18	100
JCPD4	77025	9	3	1.39	100
JCPD5	77040	10	3½	1.86	100
<b>500 PACK – 1 POWER BIT INCLUDED FREE IN 500 PACK</b>					
CPD1V	77057	8	1 <sup>5</sup> / <sub>8</sub>	3.14	500
CPD2V	77059	8	2	3.56	500
CPD3V	77074	9	2½	5.79	500
CPD4V	77075	9	3	6.84	500
CPD5V	77090	10	3½	9.32	500
<b>1000 PACK – 1 POWER BIT INCLUDED FREE IN 1000 PACK</b>					
CPD1M	77107	8	1 <sup>5</sup> / <sub>8</sub>	6.27	1000
CPD2M	77109	8	2	6.94	1000
CPD3M	77124	9	2½	11.50	1000
CPD4M	77125	9	3	13.22	1000
CPD5M	77140	10	3½	18.64	1000

OTHER SIZES AND QUANTITIES AVAILABLE BY REQUEST

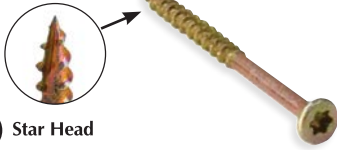

BUGLE HEAD STAR DRIVE TYPE 17 DECK SCREWS

STEEL YELLOW ZINC



PART#	UPC#	DIAMETER	LENGTH	WT. PER PKG.	STD. PKG. UM
<b>100 PACK</b>					
JRSDS1	31970	8	1¼	.61	100
JRSDS2	31971	8	1 <sup>5</sup> / <sub>8</sub>	.72	100
JRSDS3	31972	8	1¾	.83	100
JRSDS4	31973	8	2	.87	100
JRSDS5	31974	9	2½	1.20	100
JRSDS6	31975	9	3	1.47	100
JRSDS7	31976	10	3½	1.70	100
<b>500 PACK</b>					
RSDS1V	31977	8	1¼	3.05	500
RSDS2V	31978	8	1 <sup>5</sup> / <sub>8</sub>	3.60	500
RSDS3V	31979	8	1¾	4.15	500
RSDS4V	31980	8	2	4.35	500
RSDS5V	31981	9	2½	6.00	500
RSDS6V	31982	9	3	7.35	500
<b>BULK PACK</b>					
RSDS1B	31983	8	1¼	15.74	2580
RSDS2B	31984	8	1 <sup>5</sup> / <sub>8</sub>	14.40	2000
RSDS3B	31985	8	1¾	15.56	1875
RSDS4B	31986	8	2	15.23	1750
RSDS5B	31987	9	2½	14.28	1190
RSDS6B	31988	9	3	12.21	722
RSDS7B	31989	9	3½	7.48	440

OTHER SIZES AND QUANTITIES AVAILABLE BY REQUEST

FLAT/PAN/ROUND HEAD SPANNER TAMPER-RESIST MACHINE SCREWS

18-8 STAINLESS

ALL ITEMS LISTED ARE SPECIAL ORDER ITEMS  
PLEASE ALLOW 1-2 WEEKS FOR DELIVERY



SIZE	FLAT STOCK#	WT. PER PKG.	PAN STOCK#	WT. PER PKG.	STD. PKG. UM
<b>6-32</b>	<b>DRIVER SIZE #6</b>				
¼	TP324SFC	.15	-		100
3/8	TP326SFC	.20	-		100
½	TP300SFC	.23	TP300SPC	.28	100
5/8	TP327SFC	.29	-		100
¾	TP301SFC	.31	TP301SPC	.31	100
1	TP302SFC	.38	TP302SPC	.38	100
1¼	TP303SFC	.46	TP303SPC	.46	100
1½	TP304SFC	.53	TP304SPC	.53	100
2	TP305SFC	.68	TP305SPC	.76	100
3	TP701SFC	.98	TP326SPC	.99	100
4	TP353SFC	1.12	-		100
<b>8-32</b>	<b>DRIVER SIZE #8</b>				
3/8	TP328SFC	.30	-		100
½	TP306SFC	.33	TP306SPC	.35	100
5/8	TP329SFC	.41	TP328SPC	.41	100
¾	TP307SFC	.47	TP307SPC	.47	100
1	TP308SFC	.58	TP308SPC	.58	100
1¼	TP309SFC	.69	TP309SPC	.69	100
1½	TP310SFC	.80	TP310SPC	.80	100
2	TP311SFC	1.03	TP311SPC	1.03	100
3	-		TP327SPC	1.07	100

OTHER SIZES AND QUANTITIES AVAILABLE BY REQUEST



CONTINUED  
**FLAT/PAN/ROUND HEAD SPANNER TAMPER-RESIST  
 MACHINE SCREWS**  
 18-8 STAINLESS

**ALL ITEMS LISTED ARE SPECIAL ORDER ITEMS  
 PLEASE ALLOW 1-2 WEEKS FOR DELIVERY**



**SPANNER**



SIZE	FLAT STOCK#	WT. PER PKG.	PAN STOCK#	WT. PER PKG.	STD. PKG. UM
<b>10-24</b>	<b>DRIVER SIZE #10</b>				
3/8	TP330SFC	.42	-		100
1/2	TP312SFC	.49	TP312SPC	.49	100
5/8	TP331SFC	.57	-		100
3/4	TP313SFC	.57	TP313SPC	.64	100
1	TP314SFC	.78	TP314SPC	.80	100
1 1/4	TP315SFC	.93	TP315SPC	.93	100
1 1/2	TP316SFC	1.07	TP316SPC	1.07	100
2	TP317SFC	1.36	TP317SPC	1.39	100
2	-		TP624SFC	1.37	100
2 1/2	TP625SFC	1.41	-		100
<b>10-32</b>	<b>DRIVER SIZE #10</b>				
3/8	TP333SFC	.42	-		100
1/2	TP334SFC	.49	TP332SPC	.49	100
5/8	TP335SFC	.57	TP351SPC	.57	100
3/4	TP336SFC	.64	TP333SPC	.64	100
1	TP337SFC	.78	TP334SPC	.57	100
1 1/4	TP338SFC	.93	TP335SPC	.93	100
1 1/2	TP339SFC	1.07	TP336SPC	1.07	100
2	TP340SFC	1.36	TP337SPC	1.36	100
2 1/2	TP341SFC	1.35	TP338SPC	1.36	100
<b>12-24</b>	<b>DRIVER SIZE #10</b>				
1	TP124SFC	1.08	TP702SPC	1.08	100

OTHER SIZES AND QUANTITIES AVAILABLE BY REQUEST

**FLAT/PAN/ROUND HEAD SPANNER  
 TAMPER-RESIST MACHINE SCREWS**  
 18-8 STAINLESS

**ALL ITEMS LISTED ARE SPECIAL ORDER ITEMS  
 PLEASE ALLOW 1-2 WEEKS FOR DELIVERY**



**SPANNER**



SIZE	FLAT STOCK#	WT. PER PKG.	PAN STOCK#	WT. PER PKG.	STD. PKG. UM
<b>1/4-20</b>	<b>DRIVER SIZE #14</b>				
3/8	TP342SFC	.85	-		
1/2	TP318SFC	.98	TP318SPC	.98	100
1/2	-		-		
5/8	TP344SFC	1.11	-		100
3/4	TP319SFC	1.24	TP319SPC	1.24	100
1	TP346SFC	1.50	TP320SPC	1.72	100
1 1/4	TP321SFC	1.76	TP321SPC	1.76	100
1 1/2	TP322SFC	2.02	TP322SPC	2.02	100
2	TP323SFC	2.50	TP323SPC	2.54	100
2 1/2	TP350SFC	3.13	-		100
3	-		TP352SPC	3.88	100
<b>1/4-20</b>	<b>DRIVER SIZE #14</b>				
3/4	-		TP325SPC	2.40	100
4	TP353SFC	5.22	-		100

OTHER SIZES AND QUANTITIES AVAILABLE BY REQUEST

FLAT & BUTTON HEAD HEX & STAR PIN  
TAMPER-RESIST SHEET METAL SCREWS

18-8 STAINLESS



ALL ITEMS LISTED ARE SPECIAL ORDER ITEMS  
PLEASE ALLOW 1-2 WEEKS FOR DELIVERY



HEX PIN						STAR PIN					
Hex SIZE	FLAT STOCK#	WT. PER PKG.	BUTTON STOCK#	WT. PER PKG.	STD. PKG. UM	FLAT STOCK#	WT. PER PKG.	BUTTON STOCK#	WT. PER PKG.	STD. PKG. UM	Star
<b>6</b>	<b>DRIVER SIZE 1/8</b>					<b>DRIVER SIZE T10</b>		<b>DRIVER SIZE T10</b>			
3/8	TP520SFC	.23	TP520SBC	.23	100	-	-	-	-	-	-
1/2	TP500SFC	.24	TP500SBC	.25	100	TP600SFC	.18	TP600SBC	.20	100	-
5/8	TP521SFC	.28	TP521SBC	.28	100	-	-	-	-	-	-
3/4	TP501SFC	.31	TP501SBC	.31	100	TP601SFC	.25	TP601SBC	.27	100	-
1	TP502SFC	.30	TP502SBC	.34	100	TP602SFC	.32	TP602SBC	.34	100	-
1 1/2	TP503SFC	.51	TP503SBC	.55	100	TP603SFC	.48	TP603SBC	.50	100	-
<b>8</b>	<b>DRIVER SIZE 5/32</b>					<b>DRIVER SIZE T15</b>		<b>DRIVER SIZE T15</b>			
5/16	-	-	TP050SBC	.32	100	-	-	-	-	-	-
3/8	-	-	TP522SBC	.25	100	-	-	-	-	-	-
1/2	TP504SFC	.30	TP504SBC	.34	100	TP604SFC	.27	TP604SBC	.29	100	-
5/8	TP522SFC	.40	TP523SBC	.40	100	-	-	-	-	-	-
3/4	TP505SFC	.40	TP505SBC	.42	100	TP605SFC	.39	TP605SBC	.39	100	-
1	TP506SFC	.68	TP506SBC	.68	100	TP606SFC	.48	TP606SBC	.48	100	-
1 1/4	TP523SFC	.67	-	-	-	-	-	-	-	-	-
1 1/2	TP507SFC	.83	TP507SBC	.83	100	TP607SFC	.72	TP607SBC	.67	100	-
2	TP524SFC	.95	TP524SBC	.95	100	-	-	-	-	-	-
<b>10</b>	<b>DRIVER SIZE 5/32</b>					<b>DRIVER SIZE T20</b>					
1/2	TP508SFC	.41	TP508SBC	.58	100	TP608SFC	.60	TP608SBC	.41	100	-
5/8	TP525SFC	.53	TP525SBC	.53	100	-	-	-	-	-	-
3/4	TP509SFC	.58	TP509SBC	.52	100	TP609SFC	.52	TP609SBC	.52	100	-
1	TP510SFC	.69	TP510SBC	.65	100	TP610SFC	.65	TP610SBC	.65	100	-
1 1/4	TP511SFC	1.04	TP511SBC	.65	100	TP611SFC	.80	TP611SBC	.80	100	-
1 1/2	TP512SFC	1.20	TP512SBC	.94	100	TP612SFC	.83	TP612SBC	.90	100	-
2	TP513SFC	1.20	TP513SBC	1.24	100	TP613SFC	1.06	TP613SBC	1.22	100	-
2	TP624SFC	1.20	-	-	100	-	-	-	-	-	-
2 1/2	TP526SFC	1.27	TP526SBC	1.52	100	-	-	-	-	-	-
2 1/2	TP625SFC	1.27	-	-	100	-	-	-	-	-	-
<b>12</b>	<b>DRIVER SIZE 5/32</b>					<b>DRIVER SIZE T30</b>					
1/2	TP527SFC	.64	TP527SBC	.65	100	-	-	-	-	-	-
3/4	TP528SFC	.70	TP528SBC	.72	100	-	-	-	-	-	-
1	TP529SFC	.98	TP529SBC	1.00	100	-	-	-	-	-	-
1 1/4	TP530SFC	1.13	-	-	100	-	-	-	-	-	-
1 1/2	TP531SFC	1.30	TP530SBC	1.33	100	-	-	-	-	-	-
<b>14</b>	<b>DRIVER SIZE 5/32</b>					<b>DRIVER SIZE T30</b>					
1/2	TP514SFC	1.15	TP514SBC	1.15	100	TP614SFC	1.30	TP614SBC	1.30	100	-
5/8	TP532SFC	.89	TP531SBC	.90	100	-	-	-	-	-	-
3/4	TP515SFC	1.36	TP515SBC	1.36	100	TP615SFC	1.40	TP615SBC	1.40	100	-
1	TP516SFC	1.60	TP516SBC	1.60	100	TP616SFC	1.60	TP616SBC	1.60	100	-
1 1/4	TP517SFC	1.87	TP517SBC	1.87	100	TP617SFC	1.90	TP617SBC	1.90	100	-
1 1/2	TP518SFC	2.00	TP518SBC	2.00	100	TP618SFC	2.12	TP618SBC	2.12	100	-
2	TP519SFC	2.62	TP519SBC	2.62	100	TP619SFC	2.12	TP619SBC	2.12	100	-

OTHER SIZES AND QUANTITIES AVAILABLE BY REQUEST

FLAT & BUTTON HEAD HEX & STAR PIN  
TAMPER-RESIST MACHINE SCREWS

18-8 STAINLESS

ALL ITEMS LISTED ARE SPECIAL ORDER ITEMS  
PLEASE ALLOW 1-2 WEEKS FOR DELIVERY



HEX PIN					STAR PIN					
SIZE	FLAT STOCK#	WT. PER PKG.	BUTTON STOCK#	WT. PER PKG.	STD. PKG. UM	FLAT STOCK#	WT. PER PKG.	BUTTON STOCK#	WT. PER PKG.	STD. PKG. UM
<b>4-40 DRIVER SIZE 1/8</b>					<b>DRIVER SIZE T10</b>					
1/4	-	-	-	-	-	-	-	TP122SBC	.09	-
<b>6-32 DRIVER SIZE 1/8</b>					<b>DRIVER SIZE T10</b>					
1/4	-	-	TP123SBC	.16	100	TP222SFC	.18	TP223SBC	.16	100
3/8	TP122SFC	.18	TP124SBC	.20	100	TP199SFC	.20	-	-	100
1/2	TP100SFC	.28	TP100SBC	.25	100	TP200SFC	.23	TP200SBC	.23	100
1/2	TP100SFC SI	.28	(Ivory)	-	100	-	-	-	-	-
3/4	TP101SFC	.35	TP101SBC	.35	100	TP201SFC	.31	TP201SBC	.31	100
1	TP102SFC	.40	TP102SBC	.41	100	TP202SFC	.41	TP202SBC	.42	100
1	TP102SFC SI	.40	(Ivory)	-	100	-	-	-	-	-
1 1/4	TP103SFC	.49	TP103SBC	.50	100	TP203SFC	.44	TP203SBC	.43	100
1 1/2	TP104SFC	.59	TP104SBC	.57	100	TP204SFC	.56	TP204SBC	.50	100
2	TP332SFC	.72	-	-	100	-	-	-	-	-
<b>8-32 DRIVER SIZE 5/32</b>					<b>DRIVER SIZE T25</b>					
1/4	-	-	-	-	-	TP224SFC	.22	TP225SBC	.24	100
3/8	TP125SFC	.27	TP125SBC	.34	100	TP225SFC	.30	TP226SBC	.30	100
1/2	TP105SFC	.31	TP105SBC	.35	100	TP205SFC	.35	TP205SBC	.35	100
3/4	TP106SFC	.41	TP106SBC	.47	100	TP206SFC	.48	TP206SBC	.47	100
1	TP107SFC	.52	TP107SBC	.58	100	TP207SFC	.58	TP207SBC	.58	100
1 1/4	TP108SFC	.72	TP108SBC	.72	100	TP208SFC	.61	TP208SBC	.67	100
1 1/2	TP109SFC	.84	TP109SBC	.80	100	TP209SFC	.84	TP209SBC	.78	100
2	TP110SFC	1.10	TP110SBC	1.11	100	TP210SFC	1.10	TP210SBC	1.12	100
<b>10-24 DRIVER SIZE 5/32</b>					<b>DRIVER SIZE T25</b>					
3/8	TP126SFC	.37	-	-	100	TP226SFC	.37	-	-	100
1/2	TP111SFC	.44	TP111SBC	.50	100	TP227SFC	.44	TP211SBC	.49	100
	-	-	-	-	100	TP228SFC	.57	-	-	100
3/4	TP112SFC	.58	TP112SBC	.64	100	TP212SFC	.64	TP212SBC	.64	100
1	TP113SFC	.78	TP113SBC	.78	100	TP213SFC	.76	TP213SBC	.78	100
1 1/4	TP114SFC	.87	TP114SBC	.95	100	TP214SFC	.93	TP214SBC	.93	100
1 1/2	TP115SFC	.98	TPS701SBC	1.07	100	TP215SFC	1.10	TP215SBC	1.11	100
<b>10-32 DRIVER SIZE 5/32</b>					<b>DRIVER SIZE T25</b>					
3/8	TP127SFC	.37	-	-	100	TP229SFC	.42	TP227SBC	.42	100
1/2	TP128SFC	.44	-	-	100	TP623SFC	.49	TP228SBC	.49	100
5/8	-	-	-	-	-	-	-	TP229SBC	.54	100
3/4	TP129SFC	.58	-	-	100	TP231SFC	.64	TP230SBC	.64	100
1	TP130SFC	.76	TP126SBC	.78	100	TP232SFC	.78	TP231SBC	.78	100
1 1/4	-	-	-	-	-	TP233SFC	.93	TP232SBC	.93	100
1 1/2	TP131SFC	1.08	-	-	100	TP707SFC	1.04	TP233SBC	1.05	100
2	-	-	-	-	-	TP708SFC	1.13	-	-	100
<b>12-24 DRIVER SIZE 5/32</b>										
*1/2	-	-	TP704SBC	.46	100	-	-	-	-	-
1/2	-	-	TP720SBC	.44	100	-	-	-	-	-
1	TP123SFC	.22	-	-	100	-	-	-	-	-

\*BLACK OXIDE - OTHER SIZES AND QUANTITIES AVAILABLE BY REQUEST

FLAT & BUTTON HEAD HEX & STAR PIN  
TAMPER-RESIST MACHINE SCREWS

18-8 STAINLESS



ALL ITEMS LISTED ARE SPECIAL ORDER ITEMS  
PLEASE ALLOW 1-2 WEEKS FOR DELIVERY



HEX PIN					STAR PIN					
SIZE	FLAT STOCK#	WT. PER PKG.	BUTTON STOCK#	WT. PER PKG.	STD. PKG. UM	FLAT STOCK#	WT. PER PKG.	BUTTON STOCK#	WT. PER PKG.	STD. PKG. UM
<b>5/16-18 DRIVER SIZE 5/32</b>					<b>DRIVER SIZE T30</b>					
3/8	-	-	TP127SBC	1.27	100	-	-	-	-	-
1/2	TP133SFC	1.48	TP128SBC	1.88	100	-	-	-	-	-
3/4	TP134SFC	1.96	TP129SBC	2.10	100	-	-	-	-	-
1	TP135SFC	2.34	TP130SBC	2.28	100	-	-	-	-	-
1 1/4	TP136SFC	2.72	TP131SBC	3.82	100	-	-	-	-	-
1 1/2	TP137SFC	3.09	TP132SBC	3.15	100	-	-	-	-	-
2	TP138SFC	4.06	TP133SBC	4.00	100	-	-	-	-	-
<b>1/4-20 DRIVER SIZE 5/32</b>					<b>DRIVER SIZE T30</b>					
3/8	-	-	-	-	-	TP235SFC	.78	TP234SBC	.79	100
1/2	TP116SFC	.88	TP116SBC	.98	100	TP216SFC	.98	TP216SBC	.98	100
5/8	-	-	-	-	-	TP236SFC	1.04	-	-	100
3/4	TP117SFC	1.06	TP117SBC	1.24	100	TP217SFC	1.24	TP217SBC	1.24	100
1	TP118SFC	1.35	TP118SBC	1.50	100	TP218SFC	1.50	TP218SBC	1.50	100
1 1/4	TP119SFC	1.58	TP119SBC	1.76	100	TP219SFC	1.76	TP219SBC	1.76	100
1 1/2	TP120SFC	1.82	TP120SBC	2.02	100	TP220SFC	2.02	TP220SBC	2.02	100
2	TP121SFC	2.46	TP121SBC	2.54	100	TP221SFC	2.38	TP221SBC	2.38	100
<b>3/8-16 DRIVER SIZE 5/32</b>					<b>DRIVER SIZE T30</b>					
1/2	TP139SFC	2.39	TP134SBC	2.34	100	-	-	-	-	-
3/4	TP140SFC	3.10	TP135SBC	3.08	100	-	-	TP222SBC	3.10	100
1	TP141SFC	3.66	TP136SBC	3.67	100	-	-	-	-	-
1 1/4	TP142SFC	4.21	TP137SBC	4.26	100	-	-	-	-	-
1 1/2	TP143SFC	4.76	TP138SBC	4.86	100	-	-	-	-	-
2	TP144SFC	5.85	TP139SBC	6.10	100	-	-	-	-	-
<b>1/2-13 DRIVER SIZE 5/32</b>										
1	-	-	TP140SBC	6.90	100	-	-	-	-	-
1 1/2	-	-	TP141SBC	9.00	100	-	-	-	-	-
2	-	-	TP142SBC	12.00	100	-	-	-	-	-
2 1/2	-	-	TP143SBC	13.67	100	-	-	-	-	-
3	-	-	TP144SBC	16.10	100	-	-	-	-	-
3 1/2	-	-	TP145SBC	18.70	100	-	-	-	-	-

\*BLACK OXIDE - OTHER SIZES AND QUANTITIES AVAILABLE BY REQUEST

30-PIECE TAMPER-RESIST KIT



PART#	UPC#	NO. OF PIECES	WT. PER PKG.	STD. PKG. UM
TPK30	41280	30	1.04	1
<b>INCLUDES</b>		<b>BIT/PT. SIZE</b>		
Driver		1/4 (magnetic w/storage handle)		
TORX® Bits		T8, T9, T10, T15, T20, T25, T27, T30, T40		
Hex Pin Bits		3/32; 1/8; 9/64; 1/32; 3/16; 7/32; 1/4; 5/16		
Spanner Bits		6; 8; 10		
TRI-WING® Bits		1; 2; 3		
POZIDRIV® Bit		1; 2; 3		
Socket Adapter		1		
Bit Holder		1		



TAMPER-RESIST BITS



POWER INSERT BITS



Spanner  
**SPANNER BIT**



PART#	UPC#	SIZE	WT. PER PKG.
00SP4B	25034	4	.01
00SP6B	25027	6	.01
00SP8B	10195	8	.01
00SP10B	10196	10	.01
00SP12B	10194	12	.01
00SP14B	10197	14	.01
00TP06	25035	T6	.01
00TP08	25036	T8	.01
00TP09	41199	T9	.01
00TP10	41200	T10	.01
00TP15	41210	T15	.01
00TP20	41215	T20	.01
00TP25	41220	T25	.01
00TP27	41222	T27	.01
00TP30	41230	T30	.01
00TP40	25037	T40	.01
00HP16B	41253	<sup>3</sup> / <sub>32</sub>	.01
00HP18B	41255	<sup>1</sup> / <sub>8</sub>	.01
00HP964B	25033	<sup>9</sup> / <sub>64</sub>	.01
00HP32B	41260	<sup>5</sup> / <sub>32</sub>	.01



Star  
**STAR PIN (TORX)**



Hex  
**HEX PIN**



OTHER SIZES AND QUANTITIES AVAILABLE BY REQUEST



MAGNETIC HAND DRIVER

BIT STORAGE IN HANDLE  
(Order bits separately)



PART#	UPC#	SIZE/TYPE	WT. PER PKG.	STD. PKG. UM
HDT14	41265	¼ Hex	.24	1



ISOMAX®

Assortment of Insert Bits  
100 Pc. Security & Non Security Bit Kit

PART#	UPC#	WT. PER PKG.	STD. PKG. UM
EVBK100	26720	2	1

Isomax® is a registered trademark

KIT CONTAINS THE FOLLOWING BITS

TIP TYPES	TIP SIZES	LENGTH
Socket Adapters	¼	1, 2
Female Socket Adapters	¼	1
Y-Cup Hook Installer/Remover	Fits All	1
Bit Holder	¼ Hex	2- <sup>3</sup> / <sub>8</sub>
Phillips® (2) each	#0, #1, #2, #3	2/ea
Octo-Drive® fits Pozi-Drive® - (2) each	#0, #1, #2, #3	2/ea
Slotted	2, 2.5, 3, 4, 4.5, 5, 6, 7, 8	1/ea
Tee*Star®	T8, T9, T10, T15, T20, T25, T27, T30, T40	1/ea
Security Tee*Star® (fits Security Torx®)	T8, T9, T10, T15, T20, T25, T27, T30, T40	1/ea

TIP TYPES	TIP SIZES	LENGTH
Hex Key (fits Allen®)	2mm, 2.5mm, 3mm, 4mm, 5mm, 5.5mm, 6mm, 7mm, 8mm, <sup>1</sup> / <sub>16</sub> , <sup>5</sup> / <sub>64</sub> , <sup>3</sup> / <sub>32</sub> , <sup>7</sup> / <sub>64</sub> , <sup>1</sup> / <sub>8</sub> , <sup>5</sup> / <sub>32</sub> , <sup>3</sup> / <sub>16</sub> , <sup>1</sup> / <sub>4</sub> , <sup>5</sup> / <sub>16</sub>	1/ea
Security Hex (fits Security Allen®)	2mm, 2.5mm, 3mm, 4mm, 5mm, 5.5mm, 6mm	1/ea
Spanner	#4, #6, #8, #10	1/ea
Triple-Y® (fits Tri-Wing®)	1, 2, 3, 4, 6	1/ea
Tee-Cross® (fits Torq-Set®)	6, 8, 10	1/ea
Square Recess	R0, R1, R2, R3	1/ea
Spline	#4, #5, #6	1/ea

A

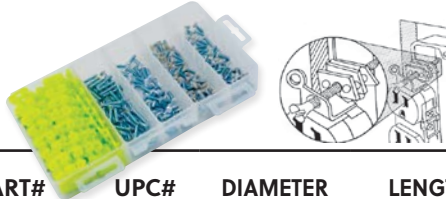

**SUPER WALL PLATE SCREW KIT**

*A complete wall plate kit to make insulation easy and safer.*

PART#	UPC#	DIAMETER	LENGTH	DESCRIPTION	WT. PER PKG.	STD. PKG. UM
SWPK1	20360	6-32	½	Slotted Oval Head White Painted Screw	.98	50
		6-32	½	Slotted Oval Head Ivory Painted Screw		
		6-32	½	Slotted Oval Head Almond Painted Screw		
		6-32	¾	Slotted Flat Head Machine Screw		
		6-32	1	Slotted Flat Head Machine Screw		
		-	-	Quick Fix GB® Spacers		

- Slotted
- Phillips
- Square Drive

Three drives in one head!



**ROUND HEAD TRI-DRIVE MACHINE SCREW KITS**  
STEEL ZINC



*Drive bit included in each pack.*



PART#	UPC#	DIAMETER	LENGTH	QTY.	WT. PER PKG.	STD. PKG. UM
TRMK632 (415 pcs)	76877	6-32	½	50	2.53	1
		6-32	¾	50		
		6-32	1	75		
		6-32	1½	100		
		6-32	2	140		
		#1	1 Square Power Bit	1		
TRMK832 (375 pcs)	76878	8-32	½	75	2.50	1
		8-32	¾	75		
		8-32	1	75		
		8-32	1¼	50		
		8-32	1½	50		
		8-32	2	50		
#2	1 Square Power Bit	1				
TRMK1032 (600 pcs)	76879	10-32	¼	200	3.92	1
		10-32	½	200		
		10-32	1	200		
		#3	2 Square Power Bit	1		
TRMK1420 (124 pcs)	76880	¼-20	½	35	2.08	1
		¼-20	¾	30		
		¼-20	1	20		
		¼-20	1¼	15		
		¼-20	1½	12		
		¼-20	2	12		
#3	2 Square Power Bit	1				

**OTHER SIZES AND QUANTITIES AVAILABLE BY REQUEST**





**MACHINE SCREW KIT**

18-8 STAINLESS STEEL



PART#	UPC#	DIAMETER	LENGTH	QTY.	WT. PER PKG.	STD. PKG. UM
SRMK1 (400 pcs)	76874	6-32	¾	50	3.72	1
		6-32	1	50		
		8-32	¾	50		
		8-32	1	50		
		10-32	¾	50		
		10-32	1	50		
		¼-20	¾	50		
¼-20	1	50				



**PAN HEAD SCREW KITS**

410 STAINLESS • 18-8 STAINLESS



Phillips





PART#	UPC#	DIAMETER	LENGTH	QTY.	WT. PER PKG.	STD. PKG. UM
TEKPK2SS 410 STAINLESS (231 pcs)	39612	6	1	100	1.54	1
		6	1½	40		
		10	1	40		
		10	1½	30		
		10	2	20		
		2	2 Phillips Power Bit			
TEKPK1SS 410 STAINLESS (381 pcs)	39611	8	½	100	1.89	1
		8	¾	60		
		8	1	50		
		10	½	80		
		10	¾	50		
		10	1	40		
2	2 Phillips Power Bit		1			
TSK10SS 18-8 STAINLESS (244 pcs)	39510	10	½	75	1.97	1
		10	¾	50		
		10	1	45		
		10	1¼	30		
		10	1½	25		
		10	2	20		
2	2 Phillips Power Bit		1			



**FLAT HEAD MACHINE SCREW KITS**

STEEL ZINC

Several popular drive styles in assorted sizes. Packed in a rigid plastic box with dividers

PART#	UPC#	DESCRIPTION OF CONTENTS	WT. PER PKG.	STD. PKG. UM
FMK632 	10263	<b>370 pcs - 6-32 Flat Head Slotted</b> 100 - ¾, 75 - 1, 75 - 1¼, 50 - 1½, 40 - 2, 30 - 3	1.79	1/25
FMK632 	10356	<b>370 pcs - 6-32 Flat Head Phillips</b> 100 - ¾, 75 - 1, 75 - 1¼, 50 - 1½, 40 - 2, 30 - 3	1.84	1/25
FMK832 	10883	<b>370 pcs - 8-32 Flat Head Slotted</b> 100 - ½, 75 - ¾, 75 - 1, 50 - 1¼, 40 - 1½, 30 - 2	1.81	1/25
FMK832 	10357	<b>370 pcs - 8-32 Flat Head Phillips</b> 100 - ¾, 75 - 1, 75 - 1¼, 50 - 1½, 40 - 2, 30 - 3	1.98	1/25

OTHER SIZES AND QUANTITIES AVAILABLE BY REQUEST





**TRUSS HEAD RECEPTACLE & WIRING DEVICE SCREW KIT**  
STEEL ZINC



Phillips/Slotted

Screws have a lead point and are steel zinc.  
Each kit includes a #1 Phillips x 2" Power Bit.

PART#	UPC#	DIAMETER	LENGTH	QTY.	WT. PER PKG.	STD. PKG. UM
TMSK1	39631	6-32	½	100	1.67	1
		6-32	¾	90		
		6-32	1	65		
		6-32	1¼	50		
		6-32	1½	40		
		6-32	2	35		



**PAN HEAD TRI-DRIVE SHEET METAL SCREW KITS**  
STEEL ZINC

Power bits and drivers included

PART#	UPC#	ITEM	WT. PER PKG.	STD. PKG. UM
TTSK8	76888	<b>300 pcs - #8 Pan Head Tri-Drive (square/phillips/slotted)</b> 100 - ½, 75 - ¾, 50 - 1, 30 - 1¼, 25 - 1½, 20 - 2 1 - #2 Bit 2 Long	1.61	1/25
		Slotted Phillips Square Drive		
TTSK10	10499	<b>245 pcs - #10 Pan Head Tri-Drive (square/phillips/slotted)</b> 75 - ½, 50 - ¾, 45 - 1, 30 - 1¼, 25 - 1½, 20 - 2 1 - #2 2 Square Drive Power Bit - 100R2B	1.75	1/25
		Slotted Phillips Square Drive		

OTHER SIZES AND QUANTITIES AVAILABLE BY REQUEST



**PAN HEAD SHEET METAL SCREW KITS**  
STEEL ZINC

Power bits and drivers included

PART#	UPC#	ITEM	WT. PER PKG.	STD. PKG. UM
TSSK8	10498	<b>300 pcs - #8 Pan Head Square Drive Recess</b> 100 - ½, 75 - ¾, 50 - 1, 30 - 1¼, 25 - 1½, 20 - 2 1 - #2 2 Square Drive Power Bit - 100R2B	1.50	1/25
		Square Drive		







OTHER SIZES AND QUANTITIES AVAILABLE BY REQUEST



**SLOTTED/HEX HEAD SHEET METAL  
SCREW KITS**  
STEEL ZINC

Power bits and  
drivers included



PART#	UPC#	ITEM	WT. PER PKG	STD. PKG. UM
<b>DSK8</b>	10496	<b>300 pcs - #8 ¼ Hex Slotted Washer Head</b> 100 - ½, 75 - ¾, 50 - 1, 30 - 1¼, 25 - 1½, 20 - 2 1 - ¼ x 1⅝ Hex Nut Driver - MT208B	1.69	1/25
 Hex				
 Slotted				
<b>DSK10</b>	10497	<b>245 pcs - #10 ⅝ Hex Slotted Washer Head</b> 75 - ½, 50 - ¾, 45 - 1, 30 - 1¼, 25 - 1½, 20 - 2 1 - ⅝ x 1⅝ Hex Nut Driver - MT210B	1.59	1/25
 Hex				
 Slotted				
<b>DSK12</b>	10473	<b>245 pcs - #12 ⅝ Hex Slotted Washer Head</b> 75 - ½, 50 - ¾, 45 - 1, 30 - 1¼, 25 - 1½, 20 - 2 1 - ⅝ x 1⅝ Hex Nut Driver - MT210B	2.47	1/25
 Hex				
 Slotted				

OTHER SIZES AND QUANTITIES AVAILABLE BY REQUEST

Four drives in  
one head

-  Hex
-  Slotted
-  Phillips
-  Square Drive



**QUADRIVE  
SELF-DRILLING TAPPING  
SCREW KIT**  
STEEL ZINC

Introduced in 1999

PART#	UPC#	DIAMETER	LENGTH	HEAD SIZE	QTY.	WT. PER PKG.	STD. PKG. UM
<b>QDSK10 (247 Pcs)</b>	76900	8	½	¼	100	1.69	1
		10	¾	⅝/16	50		
		10	1	⅝/16	45		
		10	1¼	⅝/16	30		
		10	2	⅝/16	20		
		¼ Driver	-	-	1		
		⅝/16 Driver	-	-	1		



**HEX HEAD SLOTTED  
SHARP POINT SELF-PIERCING/  
TAPPING SCREW KIT**  
STEEL ZINC



-  Hex Slotted

PART#	UPC#	DIAMETER	LENGTH	QTY.	WT. PER PKG.	STD. PKG. UM
<b>QKK1</b>	39291	8	½	200	2.23	1
		8	¾	150		
		8	1	100		
		8	1½	50		
		8	1½	50		

A



**QUADRIVE SELF-DRILLING  
TAPPING SCREW KIT**  
DOMESTIC STEEL ZINC

- Hex
- Slotted
- Phillips
- Square Drive

PART#	UPC#	DIAMETER	LENGTH	HEAD SIZE	QTY.	WT. PER PKG.	STD. PKG. UM		
QTEKDK1	39301	8	1/2	1/4	100	1.69	1		
		8	3/4	1/4	50				
		8	1	1/4	40				
		10	1/2	5/16	50				
		10	3/4	5/16	35				
		10	1	5/16	30				
								1/4 Driver	1
								5/16 Driver	1



**HEX WASHER HEAD  
TAPPING SCREWS INDENTED HEX WASHER KIT**  
STEEL ZINC

- Hex

PART#	UPC#	DIAMETER	WT. PER PKG.	STD. PKG. UM
TEKDK6	35465	6	1.47	1



**HEX HEAD SELF-DRILLING  
SCREW KIT**

410 STAINLESS • STEEL ZINC

*Kit contains #8 and #10 hex washer head with 1/4 and 5/16 nut setters.*

- Hex

PART#	UPC#	DIAMETER	LENGTH	HEAD SIZE	QTY.	WT. PER PKG.	STD. PKG. UM		
TEKDK1SS 410 STAINLESS (372 pcs)	39621	8	1/2	1/4	100	1.64	1		
		8	3/4	1/4	50				
		8	1	1/4	40				
		10	1/2	5/16	50				
		10	3/4	5/16	35				
		10	1	5/16	30				
								1/4 Driver	1
								5/16 Driver	1
TEKDK6 STEEL ZINC (262 pcs)	35465	8	1/2	1/4	50	1.69	1		
		8	3/4	1/4	50				
		8	1	1/4	40				
		10	1/2	5/16	50				
		10	3/4	5/16	35				
		10	1	5/16	30				
								Drill Chuck	1



- Phillips

**FLAT HEAD PHILLIPS WOOD SCREW KIT  
AND DISPLAY**

302 PIECE KIT • STEEL ZINC



Display

PART#	UPC#	CONTENTS	WT. PER PKG.	STD. PKG. UM
WSK10	41425	(150) 10 x 1, (86) 10 x 1 1/2, (66) 10 x 2 Screws	2.55	1
WSK10CD1	41426	#10 Wood Screw Kit Display Case -14 kits total	35.70	1



**BUGLE HEAD FINE THREAD  
DRYWALL SCREW KIT**  
STEEL BLACK PHOSPHATE

PART#	UPC#	DIAMETER	LENGTH/ITEM	QTY.	WT. EACH	STD. PKG. UM
DWSK1	12712	6	1	75	1.40	1/25
		6	1¼	50		
		6	1 <sup>5</sup> / <sub>8</sub>	40		
		6	2	30		
		8	2½	20		
		8	3	20		
		2	2 Phillips Power Bit	1		

OTHER SIZES AND QUANTITIES AVAILABLE BY REQUEST



**PAN/HEX HEAD  
SHEET METAL SCREW KITS**  
STEEL ZINC

Power bits and drivers included

PART#	UPC#	DIAMETER	LENGTH	QTY.	WT. PER PKG.	STD. PKG. UM
<b>STEEL ZINC</b>						
TSK8 (301 pcs) + Phillips - Slotted	10494	#8	½	100	1.66	1/25
		#8	¾	75		
		#8	1	50		
		#8	1¼	30		
		#8	1½	25		
		#8	2	20		
		#2 Phillips Power Bit - 100P2B	1			
TSK10 (246 pcs) + Phillips - Slotted	10495	#10	½	75	1.84	1/25
		#10	¾	50		
		#10	1	45		
		#10	1¼	30		
		#10	1½	25		
		#10	2	20		
		#2 Phillips Power Bit - 100P2B	1			

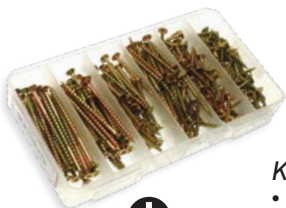

**BUGLE HEAD PHILLIPS  
COARSE THREAD DECK SCREW KIT**  
STEEL YELLOW ZINC

Kit Includes: 300 Screws

- 80 - 6 x 1
- 60 - 6 x 1<sup>5</sup>/<sub>8</sub>
- 30 - 8 x 2½
- 1 - 6
- 70 - 6 x 1¼
- 40 - 6 x 2
- 20 - 8 x 3
- COMPARTMENT BOX

PART#	UPC#	WT. PER PKG.	STD. PKG. UM
GDSK1	12704	1.99	1/25

OTHER SIZES AND QUANTITIES AVAILABLE BY REQUEST





**SELF DRILLING SCREW KITS**

STEEL ZINC

*Power bits and nut setters included*

A

PART#	UPC#	ITEM	WT. PER PKG	STD. PKG. UM
TEKDK1  Hex	10503	<b>305 pcs - #8 &amp; #10 Hex Washer Head Screws</b> #8 WITH 1/4 HEX HEAD 100 - 1/2, 50 - 3/4, 40 - 1, #10 WITH 5/16 HEX HEAD 50 - 1/2, 35 - 3/4, 30 - 1 1 - 1/4 Nut Setter - MT208B 1 - 5/16 Nut Setter - MT210B	1.69	1/25
TEKSK1  Square Drive	10504	<b>380 pcs - #8 &amp; #10 Square Drive Pan Head Screws</b> 100 - #8 1/2, 60 - #8 3/4, 50 - #8 1, 80 - #10 1/2, 50 - #10 3/4, 40 - #10 1 1 - #2 2 Square Drive Power Bit - 100R2B	1.18	1/25
TEKPK1  Phillips	10505	<b>380 pcs - #8 &amp; #10 Pan Head Phillips Screws</b> 100 - #8 1/2, 60 - #8 3/4, 50 - #8 1, 80 - #10 1/2, 50 - #10 3/4, 40 - #10 1 1 - #2 2 Phillips Power Bit - 100P2B	1.96	1/25

OTHER SIZES AND QUANTITIES AVAILABLE BY REQUEST

-  Phillips
-  Slotted



**ROUND HEAD MACHINE SCREW KITS**

STEEL ZINC











PART#	UPC#	ITEM	WT. PER PKG	STD. PKG. UM
RMK632	10894	<b>370 pcs - 6-32 Round Head Combo (Phillips/Slotted)</b> 100 - 3/4, 75 - 1, 75 - 1 1/4, 50 - 1 1/2, 40 - 2, 30 - 3	1.92	1/25
RMK832	10264	<b>370 pcs - 8-32 Round Head Combo (Phillips/Slotted)</b> 100 - 1/2, 75 - 3/4, 75 - 1, 50 - 1 1/4, 40 - 1 1/2, 30 - 2	2.28	1/25
RMK1024	10895	<b>245 pcs - 10-24 Round Head Combo (Phillips/Slotted)</b> 100 - 1/2, 50 - 3/4, 40 - 1, 30 - 1 1/4, 25 - 1 1/2	2.38	1/25
RMK1032	10501	<b>245 pcs - 10-32 Round Head Combo (Phillips/Slotted)</b> 75 - 1/2, 50 - 3/4, 40 - 1, 30 - 1 1/4, 25 - 1 1/2, 25 - 2	2.18	1/25
RMK1420	10502	<b>124 pcs - 1/4-20 Round Head Combo (Phillips/Slotted)</b> 35 - 1/2, 30 - 3/4, 20 - 1, 15 - 1 1/4, 12 - 1 1/2, 12 - 2	2.02	1/25

OTHER SIZES AND QUANTITIES AVAILABLE BY REQUEST



**STOVE BOLT KITS**  
STEEL ZINC



PART#	UPC#	ITEM	WT. PER PKG	STD. PKG. UM
<b>RSBK1</b>	10365	<b>6-32 Round Head Combo (Phillips and Slotted) MS</b>	1.23	1/25
 Phillips		50 - 1/2, 30 - 3/4, 20 - 1, 20 - 1 1/4, 15 - 1 1/2, 15 - 2		<b>TOTAL PIECES IN KIT 500</b>
 Slotted		150 - 6-32 Hex Nuts, 100 #6 SAE Washers 100 #6 Lock Washers		
<b>RSBK2</b>	10366	<b>8-32 Round Head Combo (Phillips and Slotted) MS</b>	1.64	1/25
 Phillips		50 - 1/2, 30 - 3/4, 20 - 1, 20 - 1 1/4, 15 - 1 1/2, 15 - 2		<b>TOTAL PIECES IN KIT 500</b>
 Slotted		150 - 8-32 Hex Nuts 100 #8 SAE Washers 100 #8 Lock Washers		
<b>RSBK3</b>	10367	<b>10-32 Round Head Combo (Phillips and Slotted) MS</b>	2.14	1/25
 Phillips		50 - 1/2, 30 - 3/4, 20 - 1, 20 - 1 1/4, 15 - 1 1/2, 15 - 2		<b>TOTAL PIECES IN KIT 500</b>
 Slotted		150 - 10-32 Hex Nuts 100 #10 SAE Washers 100 #10 Lock Washers		
<b>RSBK4</b>	10368	<b>1/4-20 Round Head Combo (Phillips and Slotted) MS</b>	3.25	1/25
 Phillips		35 - 1/2, 30 - 3/4, 20 - 1, 15 - 1 1/4, 12 - 1 1/2, 12 - 2		<b>TOTAL PIECES IN KIT 324</b>
 Slotted		100 - 1/4 -20 Hex Nuts 50 1/4 SAE Washers 50 1/4 Lock Washers		
<b>RSBK212</b>	13070	<b>Round Head Combo (Phillips and Slotted) MS</b>	16.50	1
 Phillips		100 - 6-32 x 2 1/2	100 - #6 Flat SAE Washers	<b>TOTAL PIECES IN KIT 1600</b>
		100 - 8-32	100 - #8	
 Slotted		100 - 10-24	200 - #10	
		100 - 10-32		
		100 - 6-32 Hex Nuts	100 - #6 Split Lock Washers	
		100 - 8-32	100 - #8	
		100 - 10-24	200 - #10	
		100 - 10-32		

OTHER SIZES AND QUANTITIES AVAILABLE BY REQUEST



## HEX NUTS



DOMESTIC STEEL ZINC • DOMESTIC GRADE 5 STEEL ZINC • GRADE 2 STEEL ZINC  
 GRADE 2 PLAIN • GRADE 2 HEAVY HEX • GRADE 5 HARDENED STEEL ZINC  
 GRADE 8 HARDENED STEEL ZINC • DOMESTIC 18-8 STAINLESS • DOMESTIC 316 STAINLESS  
 DOMESTIC SILICON BRONZE • SILICON BRONZE • BLACK OXIDE • BRASS • 18-8 STAINLESS  
 316 STAINLESS • HEAVY 18-8 STAINLESS • GALVANIZED

B

PART#	UPC#	SIZE	WT. PER PKG.	STD. PKG. UM
<b>DOMESTIC STEEL ZINC</b>				
JN160D	50069	8-32	.31	100/500
JN161D	50066	10-24	.38	100/500
JN162D	50070	10-32	.36	100/500
JN163D	50067	¼-20	.74	100/500
JN165D	50068	¾-16	1.58	100/500
JN166D	50071	½-13	1.86	50
<b>DOMESTIC GRADE 5 STEEL ZINC</b>				
JG5N163D	71505	¼-20	.78	100/500
JG5N165D	83919	¾-16	1.56	100/500
JG5N166D	60411	½-13	1.82	50/250
<b>GRADE 2 STEEL ZINC</b>				
JN150	79950	2-56	.95	100/500
JN151	79951	3-48	.94	100/500
JN157	79957	4-40	.16	100/500
JN158	79958	5-40	.26	100/500
JN159	80427	6-32	.25	100/500
JN159M	90711	6-32	2.50	1000
JN153	79953	6-40	.25	100
JN160	80428	8-32	.31	100/500
JNF160	71760	8-32	.31	100
JN161	80429	10-24	.38	100/500
JN162	80430	10-32	.36	100/500
JN156	62009	12-24	.56	100
JN163	80431	¼-20	.74	100/500
JN163M	90715	¼-20	7.17	1000
N1635M	23963	¼-20	34.44	5000
N163B	24063	¼-20	55.90	8000
JNF163	71763	¼-28	.78	100/500
N1651M	11866	¾-16	15.02	1000
N165B	24065	¾-16	37.93	2500
JN164	80432	⅝-18	1.09	100/500
JN164M	90716	⅝-18	10.90	1000
JNF164	71764	⅝-24	1.09	100/500
JN165	80433	¾-16	1.58	100/500
JNF165	71765	¾-24	1.55	100/500
JN170	83140	⅞-14	2.81	100/500
JNF171	71771	⅞-20	2.81	100/500
JN166	80434	½-13	1.86	50/250
N1661M	81867	½-13	36.49	1000
N166B	71465	½-13	75.15	2500
JNF177	71777	½-20	1.80	50
JN167	80435	⅝-11	1.81	25
N167V	14121	⅝-11	36.00	500
JN179	83149	⅝-18	3.60	50
JN168	80436	¾-10	2.91	25
N168CCL	61059	¾-10	29.10	250
JN173	28628	⅞-9	4.47	25
JN174	84308	1-8	6.96	25
JN178	84307	1¼-7	12.89	25

OTHER SIZES AND QUANTITIES AVAILABLE BY REQUEST





CONTINUED  
HEX NUTS

DOMESTIC STEEL ZINC • DOMESTIC GRADE 5 STEEL ZINC • GRADE 2 STEEL ZINC  
GRADE 2 PLAIN • GRADE 2 HEAVY HEX • GRADE 5 HARDENED STEEL ZINC  
GRADE 8 HARDENED STEEL ZINC • DOMESTIC 18-8 STAINLESS • DOMESTIC 316 STAINLESS  
DOMESTIC SILICON BRONZE • SILICON BRONZE • BLACK OXIDE • BRASS • 18-8 STAINLESS  
316 STAINLESS • HEAVY 18-8 STAINLESS • GALVANIZED

PART#	UPC#	SIZE	WT. PER PKG.	STD. PKG. UM
<b>GRADE 2 STEEL PLAIN FINISH</b>				
JN163PL	79960	¼ -20	.75	100
JN164PL	79961	5/16 -18	1.09	100
JN165PL	79962	3/8 -16	1.59	100
JN170PL	79963	7/16 -14	2.80	100
JN166PL	79964	½ -13	1.86	50
JN167PL	79965	5/8 -11	4.04	25
JN168PL	79966	¾ -10	2.91	25
<b>GRADE 2 HEAVY HEX NUT STEEL ZINC</b>				
JHHN14	86469	¼ -20	6.07	100
JHHN15	86470	5/16 -18	2.61	25/125
JHHN38	80437	3/8 -16	2.86	100
JHHN12	80438	½ -13	6.07	100
JHHN13	86468	½ -20	6.26	100/500
JHHN58	86658	5/8 -11	2.61	25/125
JHHN34	86489	¾ -10	4.73	25/125
JHHN78	86678	7/8 -9	4.73	25/125
JHHN1	86456	1-8	2.86	100
<b>GRADE 2 HEAVY HEX NUT PLAIN STEEL</b>				
JHHN34PL	86640	¾ -10	4.59	25
<b>GRADE 5 HARDENED STEEL ZINC</b>				
JG5N163	80439	¼ -20	.75	100/500
JG5N164	80440	5/16 -18	1.10	100/500
JG5N165	80441	3/8 -16	1.59	100/500
G5N165V	13985	3/8 -16	7.95	500
JG5N170	83915	7/16 -14	2.87	100/500
JG5N166	80442	½ -13	1.82	50
G5N166V	13986	½ -13	18.20	500
JG5N167	80443	5/8 -11	1.83	25
JG5N168	80444	¾ -10	2.92	25
<b>GRADE 8 HARDENED STEEL ZINC</b>				
JG8N163	80445	¼ -20	.74	100/500
JG8N163L	69139	¼ -20	.42	50
JG8N164	80446	5/16 -18	1.10	100/500
JG8N165	80447	3/8 -16	1.60	100/500
JG8N1651	64475	3/8 -24	.78	50
JG8N169	81482	7/16 -14	2.81	100/500
JG8N166	80448	½ -13	1.85	50
JG8N1661	64472	½ -20	1.80	50
JG8N167	80449	5/8 -11	1.87	25
JG8N173	81486	5/8 -18	1.83	25
JG8N168	80450	¾ -10	2.87	25
JG8N1681	64480	¾ -16	2.77	25
JG8N1881	64484	1-14	6.89	25
<b>DOMESTIC 18-8 STAINLESS</b>				
JSN10D	94810	6-32	.26	100/500
JSN11D	94811	8-32	.30	100/500
JSN13D	94813	10-32	.32	100/500
JSN14D	94814	¼ -20	.77	100/500
JSN16D	94816	3/8 -16	1.63	100
JSN16TW	91069	3/8 -16	1.63	100
JSN18D	94818	½ -13	1.92	50
JSN18D	84152	½ -20	1.92	50

OTHER SIZES AND QUANTITIES AVAILABLE BY REQUEST

CONTINUED ON NEXT PAGE  
[www.metallics.us](http://www.metallics.us)



CONTINUED  
**HEX NUTS**



DOMESTIC STEEL ZINC • DOMESTIC GRADE 5 STEEL ZINC • GRADE 2 STEEL ZINC  
 GRADE 2 PLAIN • GRADE 2 HEAVY HEX • GRADE 5 HARDENED STEEL ZINC  
 GRADE 8 HARDENED STEEL ZINC • DOMESTIC 18-8 STAINLESS • DOMESTIC 316 STAINLESS  
 DOMESTIC SILICON BRONZE • SILICON BRONZE • BLACK OXIDE • BRASS • 18-8 STAINLESS  
 316 STAINLESS • HEAVY 18-8 STAINLESS • GALVANIZED

B

PART#	UPC#	SIZE	WT. PER PKG.	STD. PKG. UM
<b>DOMESTIC 316 STAINLESS</b>				
JSN1431SSD	65366	¼-20	.80	100/500
<b>DOMESTIC SILICON BRONZE</b>				
JSBN38D	73338	¾-16	1.82	100
<b>SILICON BRONZE</b>				
JSBN6	73306	6-32	.29	100/500
JSBN8	73308	8-32	.38	100/500
JSBN24	73324	10-24	.40	100/500
JSBN32	73332	10-32	.40	100/500
JSBN14	80459	¼-20	.46	50
JSBN516	80460	5/16-18	.63	50
JSBN38	80461	¾-16	.91	50
JSBN12	80462	½-13	1.06	25
JSBN58	84340	5/8-11	1.99	25
JSBN34	72190	¾-10	2.90	25
<b>BLACK OXIDE</b>				
JN163BLACK	83064	¼-20	.75	100/500
JN165BLACK	83060	¾-16	1.55	100/500
JN166BLACK	71499	½-13	1.80	50
<b>BRASS</b>				
JN159BR	80463	6-32	.26	100/500
JN160BR	80464	8-32	.33	100/500
JN161BR	62272	10-24	.38	100/500
JN162BR	80465	10-32	.38	100/500
JN156BR	62356	12-24	.65	100/500
JN163BR	80466	¼-20	.71	100/500
JN165BR	62276	¾-16	1.73	100/500
JN171BR	63371	½-13	2.03	50
JN167BR	62278	5/8-11	1.81	25
JN164BR	62275	5/8-18	.55	50/250
JN168BR	62279	¾-10	2.91	25
<b>18-8 STAINLESS</b>				
JSN26	91059	4-40	.18	100
JSN10	80451	6-32	.26	100/500
JSN11	80452	8-32	.30	100/500
JSN12	80453	10-24	.36	100/500
JSN13	80454	10-32	.36	100/500
JSN17	91050	12-24	.60	100/500
JSN14L	69121	¼-20	.37	50
JSN14	80455	¼-20	.77	100/500
JSN23	91056	5/16-24	1.10	100
JSN16	80457	¾-16	1.63	100/500
JSN21L	69128	¾-24	.81	50
JSN21	91054	¾-24	1.58	100
JSN20	82279	7/16-14	2.85	100/500
JSN22	91055	7/16-20	2.86	100
JSN18	80458	½-13	1.92	50
JSN182	84152	½-20	1.83	50
JSN19	82278	5/8-11	7.34	100/500
JSN15	80456	5/8-18	1.10	100/500

OTHER SIZES AND QUANTITIES AVAILABLE BY REQUEST

CONTINUED  
**HEX NUTS**

DOMESTIC STEEL ZINC • DOMESTIC GRADE 5 STEEL ZINC • GRADE 2 STEEL ZINC  
 GRADE 2 PLAIN • GRADE 2 HEAVY HEX • GRADE 5 HARDENED STEEL ZINC  
 GRADE 8 HARDENED STEEL ZINC • DOMESTIC 18-8 STAINLESS • DOMESTIC 316 STAINLESS  
 DOMESTIC SILICON BRONZE • SILICON BRONZE • BLACK OXIDE • BRASS • 18-8 STAINLESS  
 316 STAINLESS • HEAVY 18-8 STAINLESS • GALVANIZED



PART#	UPC#	SIZE	WT. PER PKG.	STD. PKG. UM
<b>18-8 STAINLESS</b>				
JSN34	84313	3/4-10	2.91	25
SN25	12452	3/4-10	5.03	50
JSN24	91057	1-8	13.40	50
<b>316 STAINLESS</b>				
JSN103316SS	28789	6-32	.26	100/500
JSN11316SS	28788	8-32	.30	100/500
JSN12316SS	89312	10-24	.36	100
JSN13316SS	28787	10-32	.32	100/500
JSN14316SS	89314	1/4-20	.66	100/500
JSN15316SS	89315	5/16-18	.65	100/500
JSN16316SS	89316	3/8-16	.82	50/250
JSN20316SS	89320	7/16-14	1.48	50
JSN25316SS	89325	1/2-13	1.82	50
JSN19316SS	96719	5/8-11	3.67	50
JSN24316SS	89324	3/4-10	5.82	50
JSN22316SS	96722	7/8-9	5.18	25
<b>HEAVY 18-8 STAINLESS</b>				
JHHN13SS	63313	1/4-20	6.26	100/500
JHHN12SS	63312	1/2-13	6.05	100
JHHN34SS	63314	3/4-10	9.46	50
JHHN78SS	63378	7/8-9	4.72	25
<b>GALVANIZED</b>				
JN163G	83163	1/4-20	.81	100/500
JN164G	28633	5/16-18	1.04	100/500
JN165G	83165	3/8-16	1.60	100/500
JN166G	83166	1/2-13	1.92	50/250
N166GB	90479	1/2-13	75.15	2500
JN167G	83167	5/8-11	3.66	50
JN168G	83168	3/4-10	2.86	25
JN173G	28632	7/8-9	4.36	25
N174G	90474	1-8	2.46	10
<b>PLAIN STEEL</b>				
JHHN34PL	86640	3/4-10	4.59	25

OTHER SIZES AND QUANTITIES AVAILABLE BY REQUEST

**HEX JAM NUTS**  
 STEEL ZINC



PART#	UPC#	SIZE	WT. PER PKG.	STD. PKG. UM
<b>STEEL ZINC</b>				
JN163J	83713	1/4-20	.55	100/500
JN164J	83714	5/16-18	.76	100/500
JN165J	83715	3/8-16	1.06	100/500
JN167J	83177	5/8-18	1.81	25
JN166J	83096	1/2-13	1.86	50
JN168J	83178	3/4-10	1.83	25

OTHER SIZES AND QUANTITIES AVAILABLE BY REQUEST

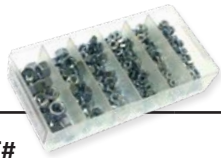

**HEX NUT KIT**  
STEEL ZINC

PART#	UPC#	SIZE	QTY.	WT. PER PKG.	STD. PKG. UM
<b>NK1</b> (400 Pcs)	10506	6-32	100	1.92	1/25
		8-32	100		
		10-32	100		
		1/4 -20	50		
		5/16 -18	30		
		3/8 -16	20		

OTHER SIZES AND QUANTITIES AVAILABLE BY REQUEST



**HEX NUT KIT**  
18-8 STAINLESS

PART#	UPC#	SIZE	QTY.	WT. PER PKG.	STD. PKG. UM
<b>SNK1</b> (400 Pcs)	90210	6-32	100	1.59	1/25
		8-32	100		
		10-32	100		
		1/4 -20	50		
		5/16 -18	30		
		3/8 -16	20		

OTHER SIZES AND QUANTITIES AVAILABLE BY REQUEST



**HEX METRIC NUTS**  
STEEL ZINC • 18-8 STAINLESS • 316 STAINLESS

PART#	UPC#	SIZE	WT. PER PKG.	STD. PKG. UM
<b>STEEL ZINC DIN934</b>				
JNM03	20133	M3	.13	100/500
JNM04	63444	M4	.21	100/500
JNM05	63445	M5	.29	100/500
JNM06	63446	M6	.53	100/500
JNM08	63448	M8	1.05	100/500
JNM10	63450	M10	2.31	100/500
JNM12	63452	M12	3.51	100
JNM16	63456	M16	4.51	100
JNM20	63460	M20	4.94	100
JNM24	63464	M24	5.22	100
<b>18-8 STAINLESS (CLASS A2.70)</b>				
JSNM4SS	95604	M4	.20	100/500
JSNM5SS	95605	M5	.27	100/500
JSNM6SS	95289	M6	.53	100/500
JSNM8SS	95291	M8	1.10	100/500
JSNM10SS	95610	M10	2.38	100/500
JSNM12SS	95612	M12	3.50	100
JSNM14SS	79975	M14	4.55	500
<b>316 STAINLESS (CLASS A4.70)</b>				
JSNM6SS316	95267	M6	.52	100/500
JSNM8SS316	95269	M8	1.11	100/500
JSNM10SS316	95271	M10	2.42	100/500
JSNM12SS316	95273	M12	3.51	100

OTHER SIZES AND QUANTITIES AVAILABLE BY REQUEST



## HEX LOCK NUTS STEEL ZINC • 18-8 STAINLESS

With External Tooth Lock  
Washer attached

PART#	UPC#	SIZE	WT. PER PKG.	STD. PKG. UM
<b>STEEL ZINC</b>				
JTLN1	80467	6-32	.28	100/500
JTLN2	80468	8-32	.33	100/500
JTLN3	80469	10-24	.39	100/500
JTLN4	80470	10-32	.40	100/500
JTLN8	90090	12-24	.66	100/500
JTLN5	80471	¼ -20	.72	100/500
JTLN5M	53088	¼ -20	7.20	1000
JTLN28	72528	¼ -28	.69	100
JTLN6	80472	5/16 -18	1.20	100/500
JTLN7	80473	3/8 -16	1.72	100/500
<b>18-8 STAINLESS</b>				
JTLN2SS	90092	8-32	.33	100/500
JTLN4SS	90094	10-32	.41	100/500
JTLN5SS	90095	¼ -20	.73	100/500
JTLN6SS	90096	5/16 -18	1.18	100/500
JTLN7SS	90097	3/8 -16	1.79	100/500

OTHER SIZES AND QUANTITIES AVAILABLE BY REQUEST



## HEX NYLON INSERT LOCK NUTS STEEL ZINC

PART#	UPC#	SIZE	WT. PER PKG.	STD. PKG. UM
<b>STEEL ZINC</b>				
JNYN159	80474	6-32	.30	100/500
JNYN160	80475	8-32	.44	100/500
JNYN161	80476	10-24	.55	100/500
JNYN162	80477	10-32	.53	100/500
JNYN170	85202	12-24	.91	100/500
JNYN163	80478	¼ -20	.84	100/500
JNYN163M	84489	¼ -20	7.66	1000
NYN163B	90668	¼ -20	29.40	3500
NYN1635M	14034	¼ -20	42.00	5000
JNYN169	85569	¼ -28	.82	100/500
JNYN164	80479	5/16 -18	1.18	100/500
JNYN174	85574	5/16 -24	1.15	100/500
JNYN165	80480	3/8 -16	1.77	100/500
JNYN171	85571	3/8 -24	1.74	100/500
JNYN172	85204	7/16 -14	2.15	100/500
JNYN173	85573	7/16 -20	2.00	100/500
JNYN166	80481	½ -13	2.26	50/250
JNYN177	85575	½ -20	4.38	100
JNYN167	80482	5/8 -11	2.19	25/100
JNYN168	80483	¾ -10	3.10	25

OTHER SIZES AND QUANTITIES AVAILABLE BY REQUEST



## HEX NYLON INSERT LOCK NUT KIT STEEL ZINC

PART#	UPC#	SIZE	QTY.	WT. PER PKG.	STD. PKG. UM
NYNK1 (410 Pcs)	11570	6-32	100	2.51	1
		8-32	100		
		10-32	100		
		¼ -20	50		
		5/16 -18	40		
		3/8 -16	20		

OTHER SIZES AND QUANTITIES AVAILABLE BY REQUEST





**HEX NYLON INSERT LOCK NUTS**

STEEL ZINC • GRADE 8 • 18-8 STAINLESS • 18-8 HEAVY HEX • 316 STAINLESS

B

PART#	UPC#	SIZE	WT. PER PKG.	STD. PKG. UM
<b>GRADE 8 FINE THREAD STEEL ZINC</b>				
JNYNF167	85577	5/8 -18	8.44	100
<b>GRADE 8 YELLOW ZINC</b>				
JG8NYN163	84596	1/4 -20	.86	100/500
JG8NYN164	84599	5/16 -24	1.19	100
JG8NYN165	84600	3/8 -16	1.86	100
JG8NYN172	84601	7/16 -14	2.12	100
JG8NYN166	84595	1/2 -13	2.28	50
JG8NYN167	84597	5/8 -11	2.22	25
JG8NYN168	84598	3/4 -10	3.12	25
<b>18-8 STAINLESS</b>				
JNYN159SS	84470	6-32	.30	100/500
JNYN160SS	84471	8-32	.45	100/500
JNYN161SS	84472	10-24	.53	100/500
JNYN162SS	84473	10-32	.52	100/500
JNYN170SS	84481	12-24	.93	100/500
JNYN163SS	84474	1/4 -20	.84	100/500
JNYN169SS	84480	1/4 -28	.83	100/500
JNYN164SS	84475	5/16 -18	1.15	100/500
JNYN164SSB	90668	5/16 -18	27.70	2500
JNYN174SS	85084	5/16 -24	1.14	100/500
JNYN165SS	84476	3/8 -16	1.81	100/500
JNYN171SS	84482	3/8 -24	1.72	100/500
JNYN172SS	84483	7/16 -14	2.14	100/500
JNYN173SS	84484	7/16 -20	2.08	100/500
JNYN166SS	84477	1/2 -13	2.15	50/250
JNYN167SS	84478	5/8 -11	4.42	50
JNYN175SS	85085	3/4 -10	6.10	50
<b>18-8 STAINLESS HEAVY HEX</b>				
JNYN165SSHH	61422	3/8 -16	1.92	100
JNYN166SSHH	61423	1/2 -13	4.76	100
<b>316 STAINLESS</b>				
JNYN1601SS	84466	8-32	.44	100/500
JNYN1631SS	84468	1/4 -20	.84	100/500
JNYN164SS316	61405	5/16 -18	1.18	100/500
JNYN165SS316	61406	3/8 -16	1.77	100/500

OTHER SIZES AND QUANTITIES AVAILABLE BY REQUEST



**HEX SERRATED FLANGE LOCK NUTS**

STEEL ZINC • 18-8 STAINLESS

PART#	UPC#	SIZE	WT. PER PKG.	STD. PKG. UM
<b>STEEL ZINC</b>				
JSFN832	82060	8-32	.60	100/500
JSFN1024	82062	10-24	.66	100/500
JSFN1032	82064	10-32	.65	100/500
JSFN1420	82066	1/4 -20	.93	100/500
SFN1420B	78443	1/4 -20	44.30	5000
JSFN51618	82068	5/16 -18	1.30	100/500
JSFN3816	82070	3/8 -16	1.90	100/500
JSFN1213	81968	1/2 -13	4.53	100/500
<b>18-8 STAINLESS</b>				
JSFN832SS	81975	8-32	.62	100
JSFN1024SS	81976	10-24	.68	100
JSFN1032SS	81977	10-32	.68	100

OTHER SIZES AND QUANTITIES AVAILABLE BY REQUEST

CONTINUED



## HEX SERRATED FLANGE LOCK NUTS

STEEL ZINC • 18-8 STAINLESS

PART#	UPC#	SIZE	WT. PER PKG.	STD. PKG. UM
<b>18-8 STAINLESS</b>				
JSFN1420SS	81978	¼ -20	.93	100
SFN1420SSB	22785	¼ -20	8.95	1000
JSFN51618SS	93815	5/16 -18	1.31	100/500
JSFN3816SS	81980	3/8 -16	1.91	100/500
JSFN1213SS	93818	½ -13	2.29	50/250

OTHER SIZES AND QUANTITIES AVAILABLE BY REQUEST



MADE IN USA



## SPRING NUTS

DOMESTIC STEEL ZINC • STEEL ZINC • 18-8 STAINLESS



PART#	UPC#	SIZE	WT. PER PKG.	STD. PKG. UM
<b>DOMESTIC STEEL ZINC SPRING NUTS</b>				
MSNR1420D	24636	¼ -20	6.68	100/500
MSNR3816D	24637	3/8 -16	8.34	100/500
MSNR1213D	24638	½ -13	9.35	100/500
<b>STEEL ZINC SPRING NUTS</b>				
MSNR1420	24641	¼ -20	6.68	100
MSNR3816	24643	3/8 -16	8.34	100
MSNR1213	24645	½ -13	7.35	100
MSNS1420*	24661	¼ -20	6.68	100
MSNS3816*	24663	3/8 -16	8.34	100
MSNS1213*	24665	½ -13	7.35	100
<b>STEEL ZINC SPRING CONE NUTS</b>				
MSNRCN1420	24642	¼ -20	6.62	100
MSNRCN3816	24644	3/8 -16	8.30	100
MSNRCN1213	24646	½ -13	7.21	100

OTHER SIZES AND QUANTITIES AVAILABLE BY REQUEST \*INDICATES SHORT SPRING



## CAP NUTS

STEEL NICKEL PLATED • 18-8 STAINLESS

PART#	UPC#	SIZE	WT. PER PKG.	STD. PKG. UM
<b>STEEL NICKEL PLATED</b>				
JCN160	81798	6-32	.30	100/500
JCN161	81799	10-24	.44	100/500
JCN163	80488	¼ -20	.75	100/500
JCN164	80489	5/16 -18	1.42	100/500
JCN165	80490	3/8 -16	1.88	100/500
JCN167	81802	5/8 -11	7.00	100
<b>18-8 STAINLESS</b>				
JCN162SS	92915	10-32	.45	100
JCN168SS	92921	12-24	.79	100/500
JCN163SS	92916	¼ -20	1.31	100/500
JCN164SS	92917	5/16 -18	2.18	100/500
JCN165SS	92918	3/8 -16	3.36	100/500

OTHER SIZES AND QUANTITIES AVAILABLE BY REQUEST





**SQUARE NUTS**  
STEEL ZINC • 18-8 STAINLESS

**B**

PART#	UPC#	SIZE	WIDTH A	THICKNESS B	WT. PER PKG.	STD. PKG. UM
<b>STEEL ZINC</b>						
JSQ2	80491	6-32	5/16	7/64	.12	100/500
JSQ3	80492	8-32	11/32	1/8	.36	100/500
JSQ4	80493	10-24	3/8	1/8	.43	100/500
JSQ5	80494	10-32	3/8	1/8	.44	100/500
JSQ6	80495	1/4 -20	7/16	3/16	.79	100/500
JSQ7	80496	5/16 -18	9/16	7/32	1.47	100/500
JSQ8	80497	3/8 -16	5/8	1/4	2.45	100/500
JSQ9	81069	1/2 -13	13/16	7/16	5.80	100
<b>18-8 STAINLESS</b>						
JSQ8SS	84838	3/8 -16	5/8	1/4	2.45	100/500

OTHER SIZES AND QUANTITIES AVAILABLE BY REQUEST



**WING NUTS**  
FORGED STEEL

PART#	UPC#	SIZE	WT. PER PKG.	STD. PKG. UM
JWNCF2	90246	6-32	.42	100
JWNCF3	90247	8-32	.77	100
JWNCF4	90248	10-24	.75	100
JWNCF5	90249	10-32	.72	100
JWNCF6	90250	1/4 -20	1.21	100
JWNCF7	90251	5/16 -18	1.84	100
JWNCF8	90252	3/8 -16	3.22	100
JWNCF9	90253	1/2 -13	7.38	100



**STAMPED WING NUTS**  
STEEL ZINC • 18-8 STAINLESS

PART#	UPC#	SIZE	WT. PER PKG.	STD. PKG. UM
<b>STEEL ZINC</b>				
JWN3	79899	8-32	.86	100/500
JWN4	79900	10-24	.74	100/500
JWN5	79901	10-32	.80	100/500
JWN6	80484	1/4 -20	1.28	100/500
JWN7	80485	5/16 -18	1.47	100/500
JWN8	80486	3/8 -16	2.75	100/500
JWN9	80487	1/2 -13	6.79	100
<b>18-8 STAINLESS</b>				
JWN2SS	90782	6-32	.80	100/500
JWN3SS	90783	8-32	.84	100/500
JWN4SS	90793	10-24	.77	100/500
JWN6SS	90785	1/4 -20	1.36	100/500
JWN7SS	90786	5/16 -18	1.99	100/500
JWN8SS	90787	3/8 -16	3.35	100/500

OTHER SIZES AND QUANTITIES AVAILABLE BY REQUEST

**CAGE NUTS**

STEEL BLACK PHOSPHATE

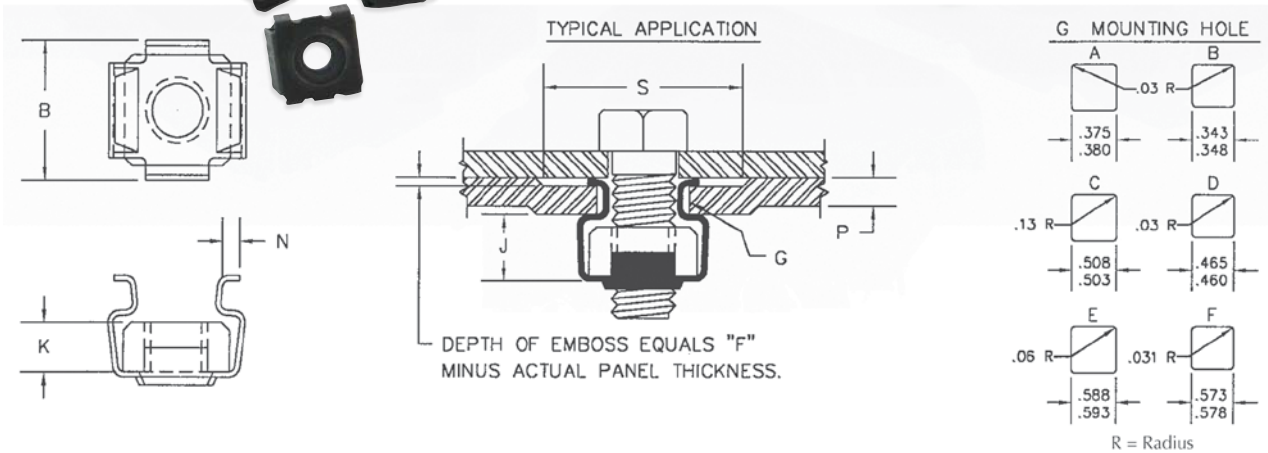

PART#	UPC#	SCREW DIA. SIZE	PANEL RANGE P	F	S	MNTG. HOLE G	B	J	N	K	WT. PER PKG.	STD. PKG. UM	SUGGESTED TRADE LIST PRICE PER
<b>CNN1024</b>	30030	10-24	.025-.063	0.1	0.531	AorB	0.52	0.06	0.6	0.156	.63	25	92.00/c
<b>CNN1032</b>	30025	10-32	.025-.063	0.1	0.531	AorB	0.52	0.06	0.6	0.156	.54	100	92.00/c
<b>CNN1032M</b>	85592	10-32	.025-.063	0.1	0.531	AorB	0.52	0.06	0.6	0.156	11.26	1000	923.58/m
<b>CNN1224</b>	30035	12-24	.025-.063	0.1	0.531	AorB	0.52	0.06	0.6	0.156	.60	50	92.00/c

OTHER SIZES AND QUANTITIES AVAILABLE BY REQUEST – SOME SIZES AVAILABLE IN STAINLESS STEEL



**CAGE NUT KITS**

STEEL BLACK PHOSPHATE

For use in telecom cabinets, relay racks and patch panels

PART#	UPC#	SCREW DIA. SIZE	SCREW LENGTH	PANEL RANGE P	MNTG. HOLE G	WT. PER PKG.	QTY.	STD. PKG. UM	SUGGESTED TRADE LIST PRICE PER
<b>CNN1024K</b>	85585	10-24	5/8	.025 - .063	AorB	.96	50 Screws 50 Nuts	1	66.88/ea
<b>CNN1032K</b>	85590	10-32	5/8	.025 - .063	AorB	.80	50 Screws 50 Nuts	1	66.88/ea
<b>CNN1224K</b>	85595	12-24	5/8	.025 - .063	AorB	.96	50 Screws 50 Nuts	1	66.88/ea

OTHER SIZES AND QUANTITIES AVAILABLE BY REQUEST



## WASHER KITS

STEEL ZINC • 18-8 STAINLESS

PART#	UPC#	ITEMS	WT. PER PKG.	STD. PKG. UM
<b>STEEL ZINC</b>				
SWK1	10507	485 pcs - Flat Washers 100 - #6, 100 - #8, 100 - #10, 75 - ¼, 50 - 5/16, 35 - 3/8, 25 - ½	1.93	1/25
LWK1	10508	425 pcs - Split Lock Washers 100 - #8, 100 - #10, 100 - ¼, 60 - 5/16, 40 - 3/8, 25 - ½	1.32	1/25
<b>18-8 STAINLESS</b>				
SSWK1	90216	400 pcs - Flat Washers 100 - #6, 100 - #8, 100 - #10, 100 - ¼	.88	1/25

OTHER SIZES AND QUANTITIES AVAILABLE BY REQUEST



## FLAT WASHERS

DOMESTIC • STEEL ZINC • 18-8 STAINLESS • 316 STAINLESS  
SILICON BRONZE • BRASS • GALVANIZED • NYLON



PART#	UPC#	I.D./O.D.	SIZE	WT. PER PKG.	STD. PKG. UM
<b>DOMESTIC STEEL ZINC</b>					
JSW72D	84186	7/32 X ½	10	.32	100
JSW73D	71506	9/32 X 5/8	¼	.52	100/500
JSW75D	84185	13/32 X 13/16	3/8	.81	100/500
JSW76D	60410	17/32 X 1 1/16	½	1.77	100/500
<b>DOMESTIC 18-8 STAINLESS</b>					
JSSW12D	78468	9/32 X 5/8	¼	.40	100/500
JSSW14D	78771	13/32 X 13/16	3/8	.61	100/500
JSSW15D	78474	17/32 X 1 1/16	½	1.40	100
<b>DOMESTIC 316 STAINLESS</b>					
JSSW121D	65321	9/32 X 5/8	¼	.36	100/500
<b>STEEL ZINC</b>					
JSW68	71968	1/8 X 5/16	4	.11	100/500
JSW69	71969	19/64 X 19/64	5	.12	100
JSW70	80498	5/32 X 3/8	6	.17	100/500
SW70B	62255	5/32 X 3/8	6	67.47	39,100
JSW71	80499	3/16 X 7/16	8	.26	100/500
SW71B	62256	3/16 X 7/16	8	58.90	28,950
JSW72	80500	7/32 X ½	10	.32	100/500
SW72B	62257	7/32 X ½	10	56.92	21,500
JSW67	71967	7/32 X ½	12	.31	100
JSW73	80501	9/32 X 5/8	¼	.46	100/500
JSW73M	90443	9/32 X 5/8	¼	4.62	1000
SW73B	62258	9/32 X 5/8	¼	42.80	10,000
JSW74	80502	11/32 X 11/16	5/16	.60	100/500
SW74M	62259	11/32 X 11/16	5/16	6.00	1000
SW74B	62259	11/32 X 11/16	5/16	58.15	9500
JSW75	80503	13/32 X 13/16	3/8	.77	100/500
JSW75M	21882	13/32 X 13/16	3/8	7.37	1000
SW75B	62260	13/32 X 13/16	3/8	36.43	5000
JSW79	86379	15/32 X 59/64	7/16	1.04	100/500
JSW76	80504	17/32 X 1 1/16	½	2.13	100/500
SW76M	11776	17/32 X 1 1/16	½	17.00	1000
SW76B	62261	17/32 X 1 1/16	½	8.10	2725

OTHER SIZES AND QUANTITIES AVAILABLE BY REQUEST

CONTINUED ON NEXT PAGE

[www.metallics.us](http://www.metallics.us)

CONTINUED

## FLAT WASHERS

DOMESTIC • STEEL ZINC • 18-8 STAINLESS • 316 STAINLESS  
SILICON BRONZE • BRASS • GALVANIZED • NYLON



PART#	UPC#	I.D./O.D.	SIZE	WT. PER PKG.	STD. PKG. UM
<b>STEEL ZINC</b>					
JSW77	80505	2 <sup>1</sup> / <sub>32</sub> X 1 <sup>5</sup> / <sub>16</sub>	5/8	2.60	100/500
SW77M	62266	2 <sup>1</sup> / <sub>32</sub> X 1 <sup>5</sup> / <sub>16</sub>	5/8	26.03	1000
SW77B	62262	2 <sup>1</sup> / <sub>32</sub> X 1 <sup>5</sup> / <sub>16</sub>	5/8	46.85	1800
JSW78	80506	1 <sup>3</sup> / <sub>16</sub> X 1 <sup>1</sup> / <sub>2</sub>	3/4	4.22	100
SW78B	62263	1 <sup>3</sup> / <sub>16</sub> X 1 <sup>1</sup> / <sub>2</sub>	3/4	43.90	1040
JSW82	71982	1 <sup>5</sup> / <sub>16</sub> X 1 <sup>3</sup> / <sub>4</sub>	7/8	5.98	100
SW80	13152	1 <sup>1</sup> / <sub>16</sub> X 2	1	8.26	100
<b>18-8 STAINLESS</b>					
JSSW16	81321	1/8 X 5/16	4	.09	100/500
JSSW22	81329	1/8 X 1/4	4	.08	100/500
JSSW8	81278	5/32 X 3/8	6	.13	100/500
JSSW10	80507	3/16 X 7/16	8	.12	100/500
JSSW11	80508	7/32 X 1/2	10	.22	100/500
JSSW19	81326	1/4 X 9/16	12	.30	100/500
JSSW12	80509	9/32 X 5/8	1/4	.40	100/500
JSSW13	80510	11/32 X 11/16	5/16	.49	100/500
SSW13B	81281	11/32 X 11/16	5/16	10.33	2500
JSSW14	80511	13/32 X 13/16	3/8	.61	100/500
JSSW20	81327	15/32 X 59/64	7/16	.77	100/500
JSSW15	80512	17/32 X 1 1/16	1/2	1.40	100/500
JSSW17	81324	21/32 X 1 5/16	5/8	2.00	100
JSSW211	81332	13/16 X 1 1/2	3/4	3.79	100
JSSW78	22750	15/16 X 1 3/4	7/8	3.62	50
JSSW21	81328	1 1/16 X 2	1	7.00	100
<b>316 STAINLESS</b>					
JSSW81	28784	5/32 X 3/8	6	.10	100/500
JSSW101	28785	3/16 X 7/16	8	.13	100
JSSW111	28786	7/32 X 1/2	10	.21	100/500
JSSW121	89521	9/32 X 5/8	1/4	.39	100/500
JSSW131	89531	11/32 X 11/16	5/16	.50	100/500
JSSW141	89541	13/32 X 13/16	3/8	.65	100/500
JSSW181	28781	15/32 X 59/64	7/16	1.30	100/500
JSSW151	89551	17/32 X 1 1/16	1/2	1.62	100/500
JSSW171	89571	21/32 X 1 5/16	5/8	2.85	100
JSSW201	89772	13/16 X 1 1/2	3/4	3.64	100
JSSW781	28637	15/16 X 1 3/4	7/8	7.25	100
<b>SILICON BRONZE</b>					
JSBW6	80513	5/32 X 3/8	6	.17	100/500
JSBW8	80514	3/16 X 7/16	8	.17	100/500
JSBW10	84410	7/32 X 1/2	10	.19	100/500
JSBW14	80516	9/32 X 5/8	1/4	.45	100/500
JSBW516	80517	11/32 X 11/16	5/16	.72	100/500
JSBW38	80518	13/32 X 1	3/8	.92	100/500
JSBW12	80519	17/32 X 1 1/16	1/2	2.40	100/500
JSBW58	84345	21/32 X 1 5/16	5/8	3.86	100
SBW34	12811	13/16 X 1 15/32	3/4	6.18	100/500
<b>BRASS</b>					
JSWBR68	85868	5/16 X 1/8	4	.09	100/500
JSWBR6	80520	5/32 X 3/8	6	.10	100/500
JSWBR8	80521	3/16 X 7/16	8	.14	100/500
JSWBR16	80522	7/32 X 1/2	10	.25	100/500
JSWBR14	80523	9/32 X 5/8	1/4	.27	100/500
JSWBR516	81806	11/32 X 11/16	5/16	.72	100

OTHER SIZES AND QUANTITIES AVAILABLE BY REQUEST

CONTINUED ON NEXT PAGE  
[www.metallics.us](http://www.metallics.us)



CONTINUED

## FLAT WASHERS

DOMESTIC • STEEL ZINC • 18-8 STAINLESS • 316 STAINLESS  
SILICON BRONZE • BRASS • GALVANIZED • NYLON

PART#	UPC#	I.D./O.D.	SIZE	WT. PER PKG.	STD. PKG. UM
<b>BRASS</b>					
JSWBR38	85838	13/32 X 13/16	3/8	.92	100/500
JSWBR12	81812	17/32 X 1 1/16	1/2	2.33	100/500
JSWBR58	81807	21/32 X 1 5/16	5/8	3.86	50
JSWBR34	81804	13/16 X 1 15/32	3/4	6.18	25
<b>GALVANIZED</b>					
JSW73G	84173	9/32 X 5/8	1/4	.68	100/500
JSW74G	84174	11/32 X 11/16	5/16	1.13	100/500
JSW75G	84175	13/32 X 13/16	3/8	1.67	100/500
SW75G5M	84165	13/32 X 13/16	3/8	83.50	5000
JSW76G	84176	17/32 X 1 1/16	1/2	3.71	100/500
JSW77G	84177	21/32 X 1 5/16	5/8	1.50	50
JSW78G	84178	13/16 X 1 1/2	3/4	2.04	50
JSW82G	84182	15/16 X 1 3/4	7/8	7.95	50
<b>NYLON</b>					
JSWN6	71916	5/32 X 3/8	6	.80	100/500
JSWN8	71917	3/16 X 7/16	8	.80	100/500
JSWN1	71911	7/32 X 1/2	10	.80	100/500
JSWN2	71912	1/4 X 1/2	1/4	.90	100/500
JSWN73	72273	9/32 X 5/8	1/4	.95	50/250
JSWN74	89705	11/32 X 11/16	5/16	.75	50/250
JSWN75	89706	3/8 X 9/16	3/8	.75	50/250

OTHER SIZES AND QUANTITIES AVAILABLE BY REQUEST



## USS FLAT WASHERS

STEEL ZINC • GRADE 5 • GRADE 8 • 18-8 STAINLESS • GALVANIZED  
• BLACK OXIDE • PLAIN STEEL

PART#	UPC#	I.D./O.D.	SIZE	WT. PER PKG.	STD. PKG. UM
<b>STEEL ZINC</b>					
JWW79	84393	1/4 X 9/16	10	.21	100
JWW80	80524	5/16 X 3/4	1/4	.61	100/500
JWW80M	81122	5/16 X 3/4	1/4	6.15	1000
WW80B	62014	5/16 X 3/4	1/4	45.20	7350
JWW81	80525	3/8 X 7/8	5/16	1.22	100/500
JWW81M	83181	3/8 X 7/8	5/16	11.95	1000
JWW82	80526	7/16 X 1	3/8	1.28	100/500
WW82M	62018	7/16 X 1	3/8	15.39	1000
WW82B	62017	7/16 X 1	3/8	51.56	3350
JWW83	80527	9/16 X 1 3/8	1/2	3.47	100
WW83M	84411	9/16 X 1 3/8	1/2	38.65	1000
WW832M	61385	9/16 X 1 3/8	1/2	64.00	2000
JWW84	80528	11/16 X 1 3/4	5/8	6.72	100
JWW85	80529	13/16 X 2	3/4	4.84	100
WW85M	84409	13/16 X 2	3/4	96.80	1000
JWW86	28635	15/16 X 2 1/4	7/8	12.98	100
JWW87L	62023	1 1/16 X 2 1/2	1	4.40	50
JWW87	84395	1 1/16 X 2 1/2	1	4.22	100
JWW88	84309	1 3/8 X 3	1 1/4	6.92	25

OTHER SIZES AND QUANTITIES AVAILABLE BY REQUEST

CONTINUED ON NEXT PAGE

[www.metallics.us](http://www.metallics.us)

CONTINUED

## USS FLAT WASHERS

STEEL ZINC • GRADE 5 • GRADE 8 • 18-8 STAINLESS • GALVANIZED  
• BLACK OXIDE • PLAIN STEEL



PART#	UPC#	I.D./O.D.	SIZE	WT. PER PKG.	STD. PKG. UM
<b>GRADE 5 ZINC</b>					
JG5WW80	82980	5/16 X 3/4	1/4	.64	100
JG5WW81	82891	3/8 X 7/8	5/16	1.01	100
JG5WW82	82892	7/16 X 1	3/8	1.29	100
JG5WW588	82002	15/32 X 59/64	7/16	2.28	100/500
JG5WW83	82982	9/16 X 1 3/8	1/2	3.53	100
JG5WW584	82000	11/16 X 1 3/4	5/8	7.40	100
JG5WW585	82001	13/16 X 2	3/4	4.92	100
<b>GRADE 8 ZINC</b>					
JG8WW80	80530	5/16 X 3/4	1/4	.61	100/500
JG8WW81	80531	3/8 X 7/8	5/16	.59	100/500
JG8WW82	80532	7/16 X 1	3/8	1.28	100/500
G8WW82M	13282	7/16 X 1	3/8	12.42	1000
JG8WW87	81443	1/2 X 1 1/4	7/16	2.04	100/500
JG8WW83	80533	9/16 X 1 3/8	1/2	3.77	100
JG8WW86	81442	11/16 X 1 3/4	5/8	7.16	100
JG8WW85	81441	13/16 X 2	3/4	9.04	100
JG8WW84	81439	15/16 X 2 1/4	7/8	13.07	100
<b>18-8 STAINLESS</b>					
JWW80SS	91080	5/16 X 3/4	1/4	.34	100
JWW81SS	91081	3/8 X 7/8	5/16	.51	100
JWW82SS	91082	7/16 X 1	3/8	.62	100/500
JWW83SS	91083	9/16 X 1 3/8	1/2	3.55	100/500
<b>GALVANIZED</b>					
JWW80G	82991	5/16 X 3/4	1/4	.70	100
JWW82G	82997	7/16 X 1	3/8	1.44	100
JWW84G	92995	11/16 X 1 3/4	5/8	1.44	100
JWW87G	82998	1 1/16 X 2 1/2	1	.70	25
<b>BLACK OXIDE</b>					
JWW83BLACK	71500	9/16 X 1 3/8	1/2	3.61	100
<b>PLAIN STEEL</b>					
JWW82PL	82025	7/16 X 1	3/8	1.28	100
JWW83PL	82026	9/16 X 1 3/8	1/2	4.84	100

OTHER SIZES AND QUANTITIES AVAILABLE BY REQUEST

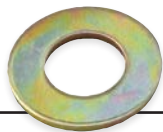

## FLAT SAE WASHER

GRADE 8 STEEL ZINC

PART#	UPC#	I.D./O.D.	SIZE	WT. PER PKG.	STD. PKG. UM
<b>GRADE 8 ZINC</b>					
JG8SW73	82973	9/32 X 5/8	1/4	.46	100
JG8SW74	82974	11/32 X 11/16	5/16	.55	100
JG8SW75	82975	13/32 X 13/16	3/8	.76	100
JG8SW76	82976	17/32 X 1 1/16	1/2	1.60	100
JG8SW77	82977	21/32 X 1 5/16	5/8	2.91	100
JG8SW78	82978	13/16 X 1 1/2	3/4	4.27	100
JG8SW79	82979	15/32 X 59/64	7/16	.97	100
JG8SW881	82986	1 1/16 X 2	1	9.21	100

OTHER SIZES AND QUANTITIES AVAILABLE BY REQUEST



## METRIC FLAT WASHERS

STEEL ZINC • 18-8 STAINLESS • 316 STAINLESS

PART#	UPC#	BOLT SIZE	WT. PER PKG.	STD. PKG. UM
<b>STEEL ZINC DIN 433</b>				
JMSW03	41730	M3	.08	100/500
JMSW04	41731	M4	.12	100/500
JMSW05	41732	M5	.15	100
JMSW06	41733	M6	.25	100
*JMSW061	41813	M6	.24	100
JMSW08	41734	M8	.40	100
JMSW081	41814	M8	.42	100
JMSW010	60877	M10	.72	100/500
*JMSW0101	41815	M10	.77	100
JMSW012	41736	M12	1.20	100/500
*JMSW0121	41816	M12	1.36	100
JMSW016	41737	M16	1.42	100
JMSW020	41738	M20	1.58	100
JMSW024	41739	M24	3.88	100
<b>18-8 STAINLESS A2 CLASS</b>				
JMSW5SS	60321	M5	.15	100
JMSW6SS	60366	M6	.23	100
JMSW8SS	60368	M8	.40	100/500
JMSW10SS	90769	M10	.69	100
JMSW12SS	90768	M12	1.31	100/500
JMSW14SS	79976	M14	1.84	100
JMSW020SS	82387	M20	3.48	100
<b>316 STAINLESS A4 CLASS</b>				
MSW3125SS316B	95726	M3	2.80	2500
JMSW6SS316	95706	M6	.24	100
JMSW8SS316	95708	M8	.41	100
JMSW10SS316	95710	M10	.50	100
JMSW12SS316	95712	M12	1.20	100

\*CLASS 10 – OTHER SIZES AND QUANTITIES AVAILABLE BY REQUEST



## FINISHING WASHERS

STEEL NICKEL • 18-8 STAINLESS

PART#	UPC#	SIZE	WT. PER PKG.	STD. PKG. UM
<b>STEEL NICKEL</b>				
JCW10	80555	6	.11	100/500
JCW11	80556	8	.16	100/500
JCW12	80557	10	.16	100/500
JCW14	80558	12	.26	100/500
<b>18-8 STAINLESS</b>				
JCW12SS	81304	10	.17	100/500
JCW14SS	53347	12	.12	100

OTHER SIZES AND QUANTITIES AVAILABLE BY REQUEST



## BELLEVILLE WASHERS (Conical)

18-8 STAINLESS

PART#	UPC#	I.D./O.D.	SIZE	WT. PER PKG.	STD. PKG. UM
JBWSS14	81691	$\frac{5}{16} \times \frac{3}{4}$	$\frac{1}{4}$	.17	1000
JBWSS38	81676	$\frac{7}{16} \times \frac{3}{4}$	$\frac{3}{8}$	.48	100/500
JBWSS12	81675	$\frac{17}{32} \times \frac{11}{8}$	$\frac{1}{2}$	1.00	100/500
JBWSS34	81671	$\frac{25}{32} \times 1\frac{5}{16}$	$\frac{3}{4}$	2.10	100
<b>HEAVY DUTY</b>					
JBWSS12HD	81677	$\frac{17}{32} \times 1\frac{1}{8}$	$\frac{1}{2}$	2.00	100

OTHER SIZES AND QUANTITIES AVAILABLE BY REQUEST





## OCTAGONAL WASHERS

STEEL ZINC

PART#	UPC#	I.D./O.D.	SIZE	WT. PER PKG.	STD. PKG. UM
JHFW114	90015	¼ x 1½	¼	2.53	100
JHFW117	90017	¾ x 1½	¾	2.37	100

OTHER SIZES AND QUANTITIES AVAILABLE BY REQUEST



## FENDER WASHERS

DOMESTIC • STEEL ZINC • DOMESTIC 18-8 STAINLESS  
18-8 STAINLESS • 316 STAINLESS • GALVANIZED



PART#	UPC#	I.D./O.D.	WT. PER PKG.	STD. PKG. UM
<b>DOMESTIC STEEL ZINC</b>				
JW113D	53370	¼ x 1	1.16	100/500
JW116D	71504	¼ x 1¼	2.44	100/500
JW114D	53371	¼ x 1½	2.34	100/500
JW119D	82916	¾ x 1¼	2.30	100/500
JW117D	63435	¾ x 1½	2.82	100
<b>DOMESTIC 18-8 STAINLESS STEEL</b>				
JW119SSD	50063	¾ x 1¼	1.37	100/500
JW113SSD	50062	¼ x 1	1.16	100/500
JW1201SSD	90777	½ x 1½	2.49	100/500
<b>STEEL ZINC</b>				
JW107	82893	1/8 x 9/16	.53	100/500
JW110	82896	3/16 x ¾	.70	100/500
JW112	80534	3/16 x 1	1.64	100/500
JW111	80535	3/16 x 1¼	2.06	100/500
JW124	82910	¼ x ½	.23	100
JW125	89911	¼ x 9/16	.24	100
JW113	80536	¼ x 1	1.35	100/500
JW113M	40213	¼ x 1	13.00	1000
W1135M	31820	¼ x 1	54.19	5000
JW116	80537	¼ x 1¼	1.56	100/500
W116V	31821	¼ x 1¼	8.04	500
W116M	14715	¼ x 1¼	18.97	1000
W116B	62229	¼ x 1¼	46.54	2300
W1165M	31822	¼ x 1¼	100.00	5000
JW114	80538	¼ x 1½	2.34	100
W114M	40223	¼ x 1½	29.58	1000
W114B	79994	¼ x 1½	73.95	2500
JW122	80539	¼ x 2	5.43	100
W122M	31823	¼ x 2	54.30	1000
JW115	80540	5/16 x 1¼	2.30	100/500
JW118	80541	5/16 x 1½	2.94	100/500
JW127	80542	¾ x 1	1.18	100/500
W127M	31824	¾ x 1	11.35	1000
JW119	80543	¾ x 1¼	1.50	100/500
W119V	31825	¾ x 1¼	11.65	500
W119M	31826	¾ x 1¼	20.90	1000
W119B	50088	¾ x 1¼	75.50	5000
JW117	80544	¾ x 1½	2.82	100
W117M	31827	¾ x 1½	27.54	1000
W117B	79993	¾ x 1½	68.80	2500
JW123	80545	¾ x 2	6.43	100
W123M	31828	¾ x 2	46.35	1000

OTHER SIZES AND QUANTITIES AVAILABLE BY REQUEST



CONTINUED

## FENDER WASHERS

DOMESTIC • STEEL ZINC • DOMESTIC 18-8 STAINLESS  
18-8 STAINLESS • 316 STAINLESS • GALVANIZED

PART#	UPC#	I.D./O.D.	WT. PER PKG.	STD. PKG. UM
<b>STEEL ZINC</b>				
JW128	23254	½ x 1¼	1.51	100
JW120	80546	½ x 1 <sup>3</sup> / <sub>8</sub>	3.37	100
W120M	21895	½ x 1 <sup>3</sup> / <sub>8</sub>	35.33	1000
JW1201	80547	½ x 1½	2.56	100
JW121	80548	½ x 2	5.18	100
<b>18-8 STAINLESS</b>				
JW112SS	90733	<sup>3</sup> / <sub>16</sub> x 1	.83	100/500
JW111SS	90751	<sup>3</sup> / <sub>16</sub> x 1¼	1.41	100/500
JW113SS	80549	¼ x 1	.95	100/500
JW116SS	80550	¼ x 1¼	1.51	100/500
JW114SS	80551	¼ x 1½	2.82	100
JW122SS	91483	¼ x 2	2.82	100
JW115SS	90752	<sup>5</sup> / <sub>16</sub> x 1¼	1.46	100/500
JW118SS	80552	<sup>5</sup> / <sub>16</sub> x 1½	2.75	100/500
JW127SS	90761	<sup>3</sup> / <sub>8</sub> x 1	.88	100/500
JW119SS	90753	<sup>3</sup> / <sub>8</sub> x 1¼	1.37	100/500
JW119SSV	98517	<sup>3</sup> / <sub>8</sub> x 1¼	6.85	500
JW117SS	80553	<sup>3</sup> / <sub>8</sub> x 1½	1.36	50/250
JW123SS	90757	<sup>3</sup> / <sub>8</sub> x 2	4.75	100
JW120SS	90754	½ x 1 <sup>3</sup> / <sub>8</sub>	3.10	100
JW1201SS	90762	½ x 1½	2.49	100
JW128SS	90774	½ x 1¼	2.46	100
JW121SS	80554	½ x 2	2.59	50
<b>316 STAINLESS</b>				
JW1161SS	91481	¼ x 1¼	1.45	100/500
JW1141SS	91513	¼ x 1½	2.79	100/500
JW1221SS	91494	¼ x 2	5.24	100/500
JW1271SS	90764	<sup>3</sup> / <sub>8</sub> x 1	.90	100/500
JW1191SS	91482	<sup>3</sup> / <sub>8</sub> x 1¼	1.87	100/500
JW1171SS	91489	<sup>3</sup> / <sub>8</sub> x 1½	2.82	100/500
JW1231SS	91495	<sup>3</sup> / <sub>8</sub> x 2	5.11	100
JW12011SS	91480	½ x 1½	2.56	100
<b>GALVANIZED</b>				
JW116G	19704	¼ x 1¼	2.17	100/500
JW119G	82905	<sup>3</sup> / <sub>8</sub> x 1¼	2.01	100/500
JW128G	98584	½ x 1¼	1.51	100

OTHER SIZES AND QUANTITIES AVAILABLE BY REQUEST



## FENDER WASHER KIT

STEEL ZINC

PART#	UPC#	DESCRIPTION OF CONTENTS	WT. PER PKG.	STD. PKG. UM
FWK10	13050	180 pcs - Fender Washers 30 - <sup>3</sup> / <sub>16</sub> x 1, <sup>3</sup> / <sub>16</sub> x 1¼, ¼ x 1, ¼ x 1¼ <sup>3</sup> / <sub>8</sub> x 1, <sup>3</sup> / <sub>8</sub> x 1¼	3.02	1/25

OTHER SIZES AND QUANTITIES AVAILABLE BY REQUEST

## SPLIT LOCKWASHERS

DOMESTIC STEEL ZINC • DOMESTIC 18-8 STAINLESS  
DOMESTIC 316 STAINLESS • DOMESTIC SILICON BRONZE • STEEL ZINC



PART#	UPC#	SIZE	WT. PER PKG.	STD. PKG. UM
<b>DOMESTIC STEEL ZINC</b>				
JLW172D	82543	¼	.29	100/500
JLW174D	82544	¾	.66	100/500
JLW175D	50065	½	1.32	100/500
<b>DOMESTIC 18-8 STAINLESS</b>				
JSLW7D	95241	¼	.31	100
JSLW9D	78766	¾	.67	100
JSLW10D	78767	½	1.40	100
<b>DOMESTIC 316 STAINLESS</b>				
JSLW91D	78775	¾	.67	100/500
<b>DOMESTIC SILICON BRONZE</b>				
JBLW38D	79008	¾	.75	100
JBLW12D	79005	½	1.41	100
<b>STEEL ZINC</b>				
JLW167	81844	4	.08	100/500
JLW168	81845	5	.09	100
JLW169	80583	6	.10	100/500
JLW170	80584	8	.11	100/500
JLW171	80585	10	.13	100/500
JLW153	81830	12	.17	100/500
JLW172	80586	¼	.29	100/500
JLW172M	74422	¼	2.35	1000
LW1725M	74445	¼	11.52	5000
JLW173	80587	5/16	.45	100/500
JLW173M	74423	5/16	4.11	1000
JLW174	80588	¾	.66	100/500
LW174M	74424	¾	6.60	1000
LW1745M	74447	¾	30.86	5000
JLW178	81894	7/16	.95	100/500
JLW175	80589	½	1.32	100/500
JLW175M	74425	½	12.90	1000
LW175-2M	74455	½	25.81	2000
JLW179	74434	9/16	13.17	100/500
JLW176	80590	5/8	2.54	100/500
JLW177	80591	¾	3.67	100
JLW180	28627	7/8	6.14	100
<b>GRADE 8 STEEL ZINC</b>				
JG8LW172	82942	¼	.30	100/500
JG8LW173	82943	5/16	.49	100
JG8LW174	82944	¾	.69	100
JG8LW175	82945	½	1.35	100
JG8LW176	82946	5/8	.68	25
JG8LW177	82947	7/16	1.04	100
JG8LW178	82948	¾	5.05	100
JG8LW179	82949	9/16	1.85	100
JG8LW200	79869	1	9.08	100
<b>18-8 STAINLESS</b>				
JSLW3	69018	4	.08	100
JSLW4	71774	6	.08	100/500
JSLW5	80592	8	.10	100/500
JSLW6	80593Z	10	.13	100/500
JSLW6V	79406	10	.65	500
JSLW12	84188	12	.16	100/500
JSLW7L	69026	¼	.18	50/250
JSLW7	80594	¼	.31	100/500
JSLW8	80595	5/16	.44	100/500
JSLW9L	69103	¾	.37	50/250

OTHER SIZES AND QUANTITIES AVAILABLE BY REQUEST

CONTINUED ON NEXT PAGE  
[www.metallics.us](http://www.metallics.us)



CONTINUED

## SPLIT LOCKWASHERS

STEEL ZINC • GRADE 8 STEEL ZINC • 18-8 STAINLESS • 316 STAINLESS • SILICON BRONZE • GALVANIZED

PART#	UPC#	SIZE	WT. PER PKG.	STD. PKG. UM
<b>18-8 STAINLESS</b>				
JSLW9	80596	3/8	.69	100/500
JSLW9TW	78779	3/8	.69	100
JSLW11	84187	7/16	.95	100/500
JSLW10L	69104	1/2	.71	50/250
JSLW10	80597	1/2	1.40	100/500
JSLW92	84892	5/8	3.32	100/500
JSLW34L	69053	3/4	1.99	50
JSLW34	72734	3/4	3.93	100
JSLW78	22751	7/8	3.98	100
JSLW1	72701	1	4.43	50
<b>316 STAINLESS</b>				
JSLW41	84894	6	.10	100
JSLW71	72771	1/4	.28	100/500
JSLW81	84881	5/16	.45	100/500
JSLW91	84891	3/8	.68	100/500
JSLW111	92991	7/16	.95	100/500
JSLW101	92981	1/2	.67	50/250
JSLW921	28640	5/8	2.49	100/500
JSLW341	28639	3/4	4.07	100
JSLW781	28638	7/8	6.74	100
<b>SILICON BRONZE</b>				
JBLW6	84160	6	.10	100/500
JBLW8	84161	8	.11	100/500
JBLW178	80598	10	.13	100/500
JBLW14	80599	1/4	.32	100/500
JBLW516	80600	5/16	.47	100/500
JBLW38	80601	3/8	.75	100/500
JBLW12	80602	1/2	1.41	100/500
JBLW58	84350	5/8	2.86	100
JBLW34	76334	3/4	4.75	100
JBLW78	76378	7/8	5.62	100
<b>GALVANIZED</b>				
JLW172G	82961	1/4	.71	100/500
JLW173G	74432	5/16	.49	100/500
JLW174G	82963	3/8	.74	100/500
LW174G5M	82968	3/8	37.00	5000
JLW175G	82964	1/2	1.48	100/500
JLW176G	82965	5/8	2.38	100
JLW177G	28631	3/4	4.08	100
JLW181G	28727	1	.71	100

OTHER SIZES AND QUANTITIES AVAILABLE BY REQUEST



## SPLIT LOCKWASHERS

GRADE 5 & 8 STEEL YELLOW ZINC

PART#	UPC#	SIZE	WT. PER PKG.	STD. PKG. UM
JLWHA172	20172	1/4	.31	100
JLWHA173	20173	5/16	.46	100
JLWHA174	20174	3/8	.67	100
JLWHA178	20178	7/16	.96	100
JLWHA175	20175	1/2	1.29	100
JLWHA176	20176	5/8	2.56	100
JLWHA177	20177	3/4	3.69	100
JLWHA180	20179	7/8	6.72	100

OTHER SIZES AND QUANTITIES AVAILABLE BY REQUEST



## SPLIT LOCKWASHERS KIT 18-8 STAINLESS STEEL

PART#	UPC#	KIT QTY. LOCKWASHERS	WT. PER PKG.	STD. PKG. UM
SLWK1 (400 pcs)	12531	100 - #6, 100 - #8, 100 - #10, 100 - ¼	1.31	1



## EXTERNAL TOOTH LOCK WASHERS STEEL ZINC • 410 STAINLESS • BRONZE

PART#	UPC#	SIZE	WT. PER PKG.	STD. PKG. UM	SUGGESTED TRADE LIST PRICE PER
<b>STEEL ZINC</b>					
JLWX1	82521	4	.03	100/500	6.24/c
JLWX2	74439	5	.05	100/500	6.24/c
JLWX3	80603	6	.07	100/500	4.17/c
JLWX4	80604	8	.09	100/500	4.27/c
JLWX5	80605	10	.10	100/500	4.44/c
JLWX5M	72635	10	.40	1000	43.12/m
JLWX12	81505	12	.12	100/500	22.12/c
JLWX6	80606	¼	.13	100/500	4.70/c
JLWX7	80607	5/16	.15	100/500	5.49/c
JLWX7M	72637	5/16	.96	1000	53.30/m
JLWX8	80608	3/8	.24	100/500	8.29/c
JLWX8M	72638	3/8	2.40	1000	80.47/m
JLWX9	80609	½	.39	100/500	11.86/c
JLWX10	81501	5/8	.58	100	77.14/c
<b>410 STAINLESS</b>					
JLWX3SS	92953	6	.08	100/500	14.49/c
JLWX4SS	92954	8	.09	100/500	6.40/c
JLWX5SS	92955	10	.16	100/500	10.37/c
JLWX6SS	92956	¼	.13	100/500	11.34/c
JLWX7SS	92957	5/16	.16	100/500	5.47/c
JLWX8SS	92958	3/8	.19	100/500	37.07/c
JLWX9SS	92959	½	.36	100/500	59.53/c
<b>SILICON BRONZE</b>					
JLWX5SB	71725	10	.09	100/500	12.88/c
JLWX7SB	71727	5/16	.16	100/500	38.02/c
JLWX8SB	71728	3/8	.18	100/500	25.83/c

OTHER SIZES AND QUANTITIES AVAILABLE BY REQUEST



## INTERNAL TOOTH LOCK WASHERS STEEL ZINC • 18-8 STAINLESS • 410 STAINLESS • METRIC

PART#	UPC#	SIZE	WT. PER PKG.	STD. PKG. UM
<b>STEEL ZINC</b>				
JLWI1	83550	4	.07	100/500
LWIX2	13605	5	.06	100/500
JLWI3	83650	6	.10	100/500
LWI3-5M	13673	6	4.96	5000
JLWI4	83652	8	.10	100/500
JLWI5	83654	10	.10	100/500
JLWI12	83551	12	.11	100/500
JLWI6	83656	¼	.10	100/500
JLWI7	83658	5/16	.17	100/500
JLWI8	83660	3/8	.23	100/500
JLWI9	83662	½	.38	100/500
LWIX58	13645	5/8	.46	100/500
<b>18-8 STAINLESS</b>				
JLWI518SS	97007	10	.10	100/500

OTHER SIZES AND QUANTITIES AVAILABLE BY REQUEST

CONTINUED ON NEXT PAGE  
[www.metallics.us](http://www.metallics.us)

CONTINUED

## INTERNAL TOOTH LOCK WASHERS

STEEL ZINC • 18-8 STAINLESS • 410 STAINLESS • METRIC



PART#	UPC#	SIZE	WT. PER PKG.	STD. PKG. UM
<b>410 STAINLESS</b>				
JLWI3SS	14648	6	.05	100/500
JLWI4SS	97013	8	.09	100/500
JLWI5SS	97014	10	.09	100/500
<b>METRIC STEEL ZINC DIN 6797</b>				
JMLWI3	60147	M3	.07	100/500
JMLWI5	60149	M5	.10	100/500
<b>METRIC 410 STAINLESS A4 CLASS</b>				
JMLWI6SS	60151	M6	.11	100/500

OTHER SIZES AND QUANTITIES AVAILABLE BY REQUEST



## METRIC LOCK WASHERS

STEEL ZINC • 18-8 STAINLESS • 316 STAINLESS

PART#	UPC#	SIZE	WT. PER PKG.	STD. PKG. UM
<b>STEEL ZINC DIN 127B</b>				
JMLW03	20131	M3	.08	100/500
JMLW04	63920	M4	.09	100/500
JMLW05	60335	M5	.13	100/500
JMLW06	63922	M6	.22	100/500
JMLW08	63924	M8	.43	100/500
JMLW010	63926	M10	.56	100/500
JMLWC010 (Curved)	63926	M10	.53	100/500
JMLW012	63928	M12	.92	100/500
JMLW016	63932	M16	.56	100
<b>HIGH COLLAR STEEL ZINC</b>				
JMLWC006 (Curved)	60131	M6	.22	100/500
JMLWHC008	60133	M8	.27	100/500
JMLWHC010	60132	M10	.46	100/500
JMLWHC012	60134	M12	.51	100/500
JMLWHC014	60137	M14	.83	100/500
JMLWHC020	60136	M20	2.55	100
<b>18-8 STAINLESS A2 CLASS</b>				
JMLW02SS	60104	M2	.07	100/500
JMLW03SS	60105	M3	.08	100/500
JMLW04SS	60106	M4	.24	100/500
JMLW06SS	60248	M6	.22	100/500
<b>STEEL ZINC DIN 127B</b>				
JMLW03	20131	M3	.08	100/500
JMLW04	63920	M4	.09	100/500
JMLW05	60335	M5	.13	100/500
JMLW06	63922	M6	.22	100/500
JMLW08	63924	M8	.43	100/500
JMLW010	63926	M10	.56	100/500
JMLWC010 (Curved)	63926	M10	.53	100/500
JMLW012	63928	M12	.92	100/500
JMLW016	63932	M16	.56	100
<b>HIGH COLLAR STEEL ZINC</b>				
JMLWC006 (Curved)	60131	M6	.22	100/500
JMLWHC008	60133	M8	.27	100/500
JMLWHC010	60132	M10	.46	100/500
JMLWHC012	60134	M12	.51	100/500
JMLWHC014	60137	M14	.83	100/500
JMLWHC020	60136	M20	2.55	100

OTHER SIZES AND QUANTITIES AVAILABLE BY REQUEST

CONTINUED ON NEXT PAGE

[www.metallics.us](http://www.metallics.us)

CONTINUED

## METRIC LOCK WASHERS

STEEL ZINC • 18-8 STAINLESS • 316 STAINLESS



PART#	UPC#	SIZE	WT. PER PKG.	STD. PKG. UM
<b>18-8 STAINLESS A2 CLASS</b>				
JMLW02SS	60104	M2	.07	100/500
JMLW03SS	60105	M3	.08	100/500
JMLW04SS	60106	M4	.24	100/500
JMLW06SS	60248	M6	.22	100/500
JMLW08SS	60117	M8	.40	100/500
JMLW10SS	60119	M10	.57	100/500
JMLW12SS	60121	M12	.85	100/500
JMLW16SS	60125	M16	.92	100/500
<b>316 STAINLESS A4 CLASS</b>				
JMLW6SS316	95731	M6	.14	50/250
JMLW8SS316	95733	M8	.40	100/500
JMLW10SS316	95735	M10	.37	100/500
JMLW12SS316	95737	M12	.86	100/500

OTHER SIZES AND QUANTITIES AVAILABLE BY REQUEST



## MASTER SEAL WASHERS

18-8 STAINLESS • GALVANIZED STEEL



PART#	UPC#	SIZE (INT. DIA.)	OVERALL DIAMETER	WT. PER PKG.	STD. PKG. UM
<b>18-8 STAINLESS</b>					
JMSWS20	91092	6	3/8	.16	100/500
JMSWS30	82381	8-10	1/2	.26	100/500
JMSWS31	82382	12-1/4	5/8	.38	100/500
JMSW22SS	60312	12	9/16	.22	100/500
MSWS35B	61170	1/4	5/8	4.12	1425
JMSWS24	82360	5/16	5/8	.30	100/500
JMSWS23	91096	5/16	3/4	.42	100/500
JMSWS25	91097	3/8	3/4	.36	100/500
<b>GALVANIZED STEEL</b>					
JMSW20	82375	6	3/8	.18	100/500
JMSW21	82376	8-10	1/2	.26	100/500
JMSW22	82377	12	9/16	.32	100/500
JMSW23	82378	1/4	5/8	.36	100/500
MSW23M	12863	1/4	5/8	3.25	1000
JMSW24	82379	5/16	3/4	.47	100/500
JMSW25	82380	3/8	3/4	.40	100/500
JMSW26	60316	1/2	1	.52	100

OTHER SIZES AND QUANTITIES AVAILABLE BY REQUEST



## STEEL BUILDING CONSTRUCTION

### MASTER SEAL® WASHER KIT

GALVANIZED STEEL



PART#	KIT UPC#	DESCRIPTION	WT. PER PKG.	STD. PKG. UM
MSWP120	12694	<b>120 pcs</b> - Plastic Box of Assorted Steel Galvanized Washers containing a total of 120 pieces. 20 each of #6, #8-10, #12, 1/4", 5/16", and 3/8"	.53	1/25

OTHER SIZES AND QUANTITIES AVAILABLE BY REQUEST





**REDUCING WASHERS**  
GALVANIZED STEEL

PART#	UPC#	TRADE SIZE*	WT. PER PKG.	STD. PKG. UM
JR100	80559	½ x ¾	.92	100/500
JR101	80560	½ x 1	1.60	100/500
JR102	80561	¾ x 1	1.34	100/500
JR103	80562	½ x 1¼	1.44	50/250
JR104	80563	¾ x 1¼	1.14	50/250
JR105	80564	1 x 1¼	1.02	50/250
JR106	80565	½ x 1½	2.11	50/250
JR107	80566	¾ x 1½	2.12	50/250
JR108	80567	1 x 1½	2.01	50/250
JR109	80568	1¼ x 1½	1.42	50
JR110	80569	½ x 2	3.54	50
JR111	80570	¾ x 2	3.05	50
JR112	80571	1 x 2	3.30	50
JR113	80572	1¼ x 2	2.98	50
JR114	80573	1½ x 2	2.63	50
JR115	80574	¾ x 2½	4.74	50
JR116	80575	1 x 2½	4.22	50
JR117	80576	1¼ x 2½	3.10	50
JR118	80577	1½ x 2½	3.09	50
JR119	80578	2 x 2½	2.22	50
R120	40075	2 x 3	3.90	25
R121	40080	2 x 3½	2.92	10
R122	40085	2½ x 4	3.25	10
R123	40090	3 x 4	2.71	10

OTHER SIZES AND QUANTITIES AVAILABLE BY REQUEST \*Trade size for pipe dimensions



**BAR JOIST WASHERS**  
GALVANIZED STEEL

PART#	UPC#	SIZE	WT. PER PKG.	STD. PKG. UM
JBWG14	81497	¼	7.16	100
JBWG38	81498	¾	7.11	100

OTHER SIZES AND QUANTITIES AVAILABLE BY REQUEST



**SQUARE WASHERS**  
GALVANIZED STEEL • 18-8 STAINLESS STEEL • STEEL ZINC

PART#	UPC#	SIZE	WT. PER PKG.	STD. PKG. UM
<b>GALVANIZED STEEL</b>				
JSQW73G	60482	¼	16.30	100/500
JSQW76G	60479	½	12.10	100/500
SQW5G	13175	5/8	33.20	250
SQW77G	13178	5/8	11.07	50
<b>18-8 STAINLESS STEEL</b>				
MSCW14SS	60864	¼	6.43	50
MSCW38SS	60863	¾	7.75	50
MSCW12SS	60862	½	4.52	25
<b>STEEL ZINC</b>				
MSCW516	24652	1/32	15.34	100
MSCW38	24653	7/16	15.34	100
MSCW12	24655	9/16	17.71	100
MSCW34	24657	¾	17.71	100

OTHER SIZES AND QUANTITIES AVAILABLE BY REQUEST



**HEX BOLTS**  
BRASS

PART#	UPC#	DIAMETER	LENGTH	WT. PER PKG.	STD. PKG. UM
JBRHC11	19493	¼-20	½	1.30	100
JBRHC48	19532	¼-20	5/8	1.28	100
JBRHC1	19494	¼-20	¾	1.64	100
JBRHC2	86702	¼-20	1	1.92	100
JBRHC49	19533	¼-20	1¼	2.14	100
JBRHC3	19492	¼-20	1½	2.48	100
JBRHC50	19489	¼-20	1¾	2.52	100
JBRHC4	19491	¼-20	2	3.04	100
JBRHC51	19490	¼-20	2¼	3.52	100
JBRHC5	19534	¼-20	2½	3.66	100
JBRHC52	86752	¼-20	2¾	3.68	100
JBRHC6	19544	¼-20	3	4.22	100
JBRHC40	86740	5/16-18	½	2.15	100
JBRHC101	19495	5/16-18	5/8	2.19	100
JBRHC42	19527	5/16-18	¾	2.60	100
JBRHC43	19528	5/16-18	1	3.04	100
JBRHC54	19538	5/16-18	1¼	4.23	100
JBRHC13	19499	5/16-18	1½	4.62	100
JBRHC104	19497	5/16-18	1¾	4.70	100
JBRHC14	86714	5/16-18	2	4.99	100
JBRHC103	19496	5/16-18	2¼	5.32	100
JBRHC15	19501	5/16-18	2½	5.53	100
JBRHC57	19541	5/16-18	2¾	5.92	100
JBRHC16	19502	5/16-18	3	6.29	100
JBRHC88	19558	3/8-16	½	2.86	100
JBRHC105	19498	3/8-16	5/8	3.13	100
JBRHC44	19529	3/8-16	¾	3.80	100
JBRHC45	86745	3/8-16	1	4.20	100
JBRHC59	19543	3/8-16	1¼	4.75	100
JBRHC23	19509	3/8-16	1½	5.60	100
JBRHC60	19545	3/8-16	1¾	6.89	100
JBRHC24	86724	3/8-16	2	7.31	100
JBRHC61	19546	3/8-16	2¼	3.99	50
JBRHC25	19511	3/8-16	2½	4.39	50
JBRHC62	19547	3/8-16	2¾	4.71	50
JBRHC26	19512	3/8-16	3	5.19	50
JBRHC86	19556	½-13	¾	3.70	50
JBRHC46	19530	½-13	1	4.25	50
JBRHC64	19549	½-13	1¼	4.82	50
JBRHC47	19531	½-13	1½	5.63	50
JBRHC65	19550	½-13	1¾	5.85	50
JBRHC33	86733	½-13	2	6.85	50
JBRHC66	19551	½-13	2¼	7.46	50
JBRHC34	19519	½-13	2½	8.23	50
JBRHC67	19552	½-13	2¾	8.90	50
JBRHC35	86735	½-13	3	9.50	50

OTHER SIZES AND QUANTITIES AVAILABLE BY REQUEST



## HEX BOLT KITS STEEL ZINC

- Each kit contains Nuts, Flat Washers, Split Lock Washers and three of the most common lengths of Hex Head Bolts.
- Kits are available in ¼-20, 3/8-16, and ½-13.

PART#	UPC#	ITEM	DIAMETER/SIZE	LENGTH	WT. PER PKG.	STD. PKG. UM
<b>BHCK1420</b> (700 pcs)	24484	Hex Head Bolts	¼-20	¾	5.61	50
		Hex Head Bolts	¼-20	1		50
		Hex Head Bolts	¼-20	1½		50
		Split Lock Washers	¼	—		200
		Flat SAE Washers	¼	—		200
		Hex Nuts	¼-20	—		150
<b>BHCK3816</b> (480 pcs)	24485	Hex Head Bolts	¾-16	1	8.12	40
		Hex Head Bolts	¾-16	1¼		30
		Hex Head Bolts	¾-16	1½		20
		Split Lock Washers	¾	—		150
		Flat SAE Washers	¾	—		150
		Hex Nuts	¾-16	—		90
<b>BHCK1213</b> (240 pcs)	24486	Hex Head Bolts	½-13	1	8.62	20
		Hex Head Bolts	½-13	1½		15
		Hex Head Bolts	½-13	2		10
		Split Lock Washers	½	—		75
		Flat SAE Washers	½	—		75
		Hex Nuts	½-13	—		45



## HEX HEAD SLOTTED MACHINE SCREW STEEL ZINC • STAINLESS STEEL

PART#	UPC#	DIAMETER	LENGTH	WT. PER PKG.	STD. PKG. UM
<b>STEEL ZINC</b>					
JHHMS80	86576	6-32	½	.33	100/500
JHHMS81	86562	6-32	¾	.38	100/500
JHHMS82	86565	6-32	¾	.43	100/500
JHHMS63	86563	6-32	1	.46	100/500
JHHMS68	86564	6-32	1¼	.52	100/500
JHHMS84	86570	8-32	½	.47	100/500
JHHMS85	86571	8-32	¾	.54	100/500
JHHMS86	86572	8-32	1	.67	100/500
JHHMS87	86573	8-32	1¼	.77	100/500
JHHMS33	86588	10-32	½	.59	100/500
JHHMS48	86589	10-32	¾	.75	100/500
JHHMS34	86554	10-32	1	.87	100/500
JHHMS98	86556	10-32	1	.94	100/500
JHHMS69	86591	10-32	1¼	.98	100/500
JHHMS70	86610	10-32	1½	1.15	100
JHHMS88	86574	12-24	¾	.99	100/500
JHHMS89	86575	¼-20	¾	1.20	100/500
JHHMS89M	85679	¼-20	¾	12.76	1000
JHHMS90	86580	¼-20	1	1.41	100/500
JHHMS94	85680	5/16-18	1¼	2.90	100
JHHMS96	86585	¾-16	1¼	4.63	100
<b>STAINLESS STEEL</b>					
JHHMS86SS	68686	8-32	1	.66	100/500
JHHMS33SS	86559	10-32	½	.63	100/500
JHHMS48SS	86558	10-32	¾	7.50	100/500
JHHMS34SS	86555	10-32	1	.87	100/500
JHHMS35SS	80870	10-32	2	1.60	100

OTHER SIZES AND QUANTITIES AVAILABLE BY REQUEST



STEEL ZINC    PLAIN STEEL    GALVANIZED

## HEX BOLTS

STEEL ZINC • PLAIN STEEL • GALVANIZED



PART#	UPC#	DIAMETER	LENGTH	WT. PER PKG.	STD. PKG. UM
<b>STEEL ZINC</b>					
JBHC92	82211	¼-20	¾	1.08	100/500
JBHC11	80610	¼-20	½	1.24	100/500
JBHC48	80611	¼-20	⅝	1.32	100/500
JBHC1	80612	¼-20	¾	1.47	100/500
JBHC2	80613	¼-20	1	1.72	100/500
BHC2M	74902	¼-20	1	17.10	1000
BHC25M	75107	¼-20	1	85.60	5000
JBHC49	80614	¼-20	1¼	2.11	100
JBHC3	80615	¼-20	1½	2.47	100
BHC3V	27175	¼-20	1½	11.83	500
JBHC50	80616	¼-20	1¾	2.82	100
JBHC4	80617	¼-20	2	3.22	100
JBHC51	82177	¼-20	2¼	3.55	100
JBHC5	80618	¼-20	2½	3.90	100
JBHC52	82178	¼-20	2¾	4.27	100
JBHC6	80619	¼-20	3	4.45	100
JBHC7	80620	¼-20	3½	3.92	100
JBHC8	80621	¼-20	4	5.95	100
JBHC9	80622	¼-20	4½	6.66	100
JBHC10	82140	¼-20	5	7.41	100
JBHC53	82179	¼-20	5½	8.00	100
JBHC12	82142	¼-20	6	8.75	100
JBHC40	85540	⅝-18	½	2.02	100/500
JBHC101	82221	⅝-18	⅝	2.18	100/500
JBHC42	80623	⅝-18	¾	2.48	100/500
JBHC43	80624	⅝-18	1	2.83	100/500
JBHC54	80625	⅝-18	1¼	3.31	100/500
JBHC13	80626	⅝-18	1½	3.91	100
JBHC14	80627	⅝-18	2	4.98	100
JBHC561	82191	⅝-18	2¼	5.49	100
JBHC15	80628	⅝-18	2½	6.09	100
JBHC57	85557	⅝-18	2¾	6.10	100
JBHC16	80629	⅝-18	3	7.11	100
JBHC17	82147	⅝-18	3½	8.16	100
BHC18	15137	⅝-18	4	10.72	100
BHC19	15138	⅝-18	4½	11.65	100
JBHC20	82150	⅝-18	5	12.59	100
JBHC58	82180	⅝-18	5½	13.46	100
JBHC22	82152	⅝-18	6	14.35	50
JBHC88	80630	⅜-16	½	2.86	100/500
BHC88M	24052	⅜-16	½	28.72	1000
JBHC44	80631	⅜-16	¾	3.80	100
BHC44M	24042	⅜-16	¾	36.40	1000
JBHC45	80632	⅜-16	1	4.20	100
BHC45CB	21855	⅜-16	1	10.50	250
BHC45M	75111	⅜-16	1	40.17	1000
BHC455M	75115	⅜-16	1	202.68	5000
JBHC59	80633	⅜-16	1¼	4.75	100
BHC59CB	21850	⅜-16	1¼	11.88	250
BHC59V	27180	⅜-16	1¼	22.93	500
JBHC23	80634	⅜-16	1½	5.47	100
BHC23M	75105	⅜-16	1½	54.40	1000
JBHC60	80635	⅜-16	1¾	6.47	100

OTHER SIZES AND QUANTITIES AVAILABLE BY REQUEST

CONTINUED



STEEL ZINC    PLAIN STEEL    GALVANIZED

## HEX BOLTS

STEEL ZINC • PLAIN STEEL • GALVANIZED



PART#	UPC#	DIAMETER	LENGTH	WT. PER PKG.	STD. PKG. UM
<b>STEEL ZINC</b>					
JBHC24	80636	3/8-16	2	7.31	100
BHC24V	24020	3/8-16	2	34.00	500
JBHC61	80637	3/8-16	2¼	3.99	50
JBHC25	80638	3/8-16	2½	4.39	50
JBHC62	82182	3/8-16	2¾	4.67	100
JBHC26	80639	3/8-16	3	5.19	50
BHC26CC	27181	3/8-16	3	22.00	200
JBHC27	80640	3/8-16	3½	6.02	50
JBHC28	82157	3/8-16	4	6.75	50
JBHC29	82158	3/8-16	4½	7.23	50
JBHC30	82159	3/8-16	5	8.24	50
JBHC63	82183	3/8-16	5½	9.05	50
JBHC32	15145	3/8-16	6	19.02	100
BHC103	15363	3/8-16	8	10.82	50
JBHC93	82212	7/16-14	1	5.83	100
JBHC94	82213	7/16-14	1¼	6.80	100
JBHC95	82214	7/16-14	1½	8.18	100
JBHC96	82215	7/16-14	2	9.06	100
JBHC97	82216	7/16-14	2½	10.02	100
JBHC98	82217	7/16-14	3	12.75	100
JBHC99	82218	7/16-14	3½	15.66	100
JBHC86	82205	½-13	¾	7.39	100
BHC86M	24050	½-13	¾	73.90	1000
JBHC46	80641	½-13	1	4.25	50
BHC46M	75122	½-13	1	86.00	1000
JBHC64	80642	½-13	1¼	4.82	50
BHC64V	24048	½-13	1¼	46.64	500
JBHC47	80643	½-13	1½	5.53	50
BHC47C	27179	½-13	1½	10.50	100
BHC47V	24045	½-13	1½	52.13	500
JBHC65	80644	½-13	1¾	5.85	50
JBHC33	80645	½-13	2	6.85	50
BHC33V	24030	½-13	2	68.50	500
JBHC66	80646	½-13	2¼	7.46	50
JBHC34	80647	½-13	2½	8.23	50
JBHC67	80648	½-13	2¾	8.75	50
JBHC35	80649	½-13	3	9.50	50
BHC35CC	24032	½-13	3	38.00	200
JBHC89	82208	½-13	3¼	5.16	25
JBHC36	82175	½-13	3½	5.57	25
JBHC37	82176	½-13	4	6.25	25
BHC38	15160	½-13	4½	27.00	100
BHC39	15161	½-13	5	29.80	100
BHC68	15185	½-13	5½	32.05	100
BHC41	15162	½-13	6	36.08	100
JBHC21	80650	5/8-11	1	7.79	50
JBHC31	80651	5/8-11	1½	9.23	50
JBHC55	82187	5/8-11	1¾	10.37	50
JBHC69	82186	5/8-11	2	10.94	50
BHC70	15187	5/8-11	2¼	24.50	100
JBHC71	80653	5/8-11	2½	13.30	50
JBHC72	82189	5/8-11	2¾	7.11	25
BHC73	15190	5/8-11	3	9.64	50

OTHER SIZES AND QUANTITIES AVAILABLE BY REQUEST

CONTINUED ON NEXT PAGE

CONTINUED



STEEL ZINC    PLAIN STEEL    GALVANIZED

## HEX BOLTS

STEEL ZINC • PLAIN STEEL • GALVANIZED



PART#	UPC#	DIAMETER	LENGTH	WT. PER PKG.	STD. PKG. UM
<b>STEEL ZINC</b>					
BHC74	15191	5/8-11	3¼	31.90	100
JBHC75	80655	5/8-11	3½	7.02	25
JBHC76	82193	5/8-11	4	9.18	25
BHC80	82197	5/8-11	5	10.80	25
BHC586	15110	5/8-11	6	45.96	100/500
BHC87	15262	5/8-11	12	27.00	25
BHC7612	15202	¾-10	1½	14.36	50
JBHC56	82188	¾-10	1¾	8.15	25
BHC77	15194	¾-10	2	17.05	50
JBHC70	82190	¾-10	2¼	9.37	25
BHC78	15195	¾-10	2½	35.76	100
BHC79	15196	¾-10	2½	19.90	50
BHC81	15181	¾-10	3	23.60	50
BHC82	43163	¾-10	3¼	49.95	100
JBHC83	82203	¾-10	3½	12.24	25
BHC85	15240	¾-10	4	17.50	25
BHC145	15375	¾-10	4½	33.11	50
BHC91	15277	¾-10	7	24.00	25
BHC105	15365	7/8-9	2¼	28.92	50
BHC107	15368	7/8-9	2¾	30.19	50
BHC108	15388	7/8-9	4	57.04	25
<b>PLAIN STEEL</b>					
JBHC11PL	78901	¼-20	½	1.18	100
JBHC1PL	78902	¼-20	¾	1.44	100
JBHC2PL	78903	¼-20	1	1.71	100
JBHC49PL	78904	¼-20	1¼	2.08	100
JBHC3PL	78905	¼-20	1½	2.43	100
JBHC4PL	78907	¼-20	2	3.12	100
JBHC50PL	78906	¼-20	1¾	2.77	100
JBHC51PL	78908	¼-20	2¼	3.46	100
JBHC5PL	78909	¼-20	2½	3.81	100
JBHC52PL	78910	¼-20	2¾	4.16	100
JBHC6PL	78911	¼-20	3	4.49	100
JBHC7PL	78912	¼-20	3½	5.19	100
JBHC8PL	78913	¼-20	4	5.94	100
JBHC88PL	78927	3/8-16	½	2.86	100
JBHC44PL	78928	3/8-16	¾	3.54	100
JBHC45PL	78929	3/8-16	1	4.20	100
BHC45PLV	15283	3/8-16	1	20.68	500
JBHC59PL	78930	3/8-16	1¼	4.85	100
JBHC23PL	78931	3/8-16	1½	5.63	100
BHC23PLV	79000	3/8-16	1½	27.92	500
JBHC60PL	78932	3/8-16	1¾	6.41	100
JBHC24PL	78934	3/8-16	2	7.18	100
JBHC61PL	78935	3/8-16	2¼	7.98	100
JBHC25PL	78936	3/8-16	2½	8.74	100
JBHC62PL	78937	3/8-16	2¾	10.30	100
JBHC26PL	78938	3/8-16	3	10.91	50
JBHC27PL	78939	3/8-16	3½	12.04	50
JBHC28PL	78940	3/8-16	4	13.50	50
JBHC40PL	78914	5/16-18	½	2.02	100
JBHC42PL	78915	5/16-18	¾	2.41	100
JBHC43PL	78916	5/16-18	1	2.83	100

OTHER SIZES AND QUANTITIES AVAILABLE BY REQUEST

CONTINUED



STEEL ZINC    PLAIN STEEL    GALVANIZED

## HEX BOLTS

STEEL ZINC • PLAIN STEEL • GALVANIZED



PART#	UPC#	DIAMETER	LENGTH	WT. PER PKG.	STD. PKG. UM
<b>PLAIN STEEL</b>					
JBHC54PL	78917	5/16-18	1¼	3.15	100
JBHC13PL	78918	5/16-18	1½	3.91	100
JBHC74PL	78919	5/16-18	1¾	4.44	100
JBHC14PL	78920	5/16-18	2	4.98	100
JBHC561PL	78921	5/16-18	2¼	5.51	100
JBHC15PL	78922	5/16-18	2½	6.05	100
JBHC57PL	78923	5/16-18	2¾	6.59	100
JBHC16PL	78924	5/16-18	3	7.13	100
JBHC17PL	78925	5/16-18	3½	8.20	100
JBHC103PL	78926	5/16-18	4	9.28	100
JBHC93PL	78941	7/16-18	1	5.83	100
JBHC94PL	78942	7/16-18	1¼	6.80	100
JBHC95PL	78943	7/16-18	1½	8.18	100
JBHC104PL	78944	7/16-18	1¾	8.88	100
JBHC96PL	78945	7/16-18	2	9.06	100
JBHC105PL	78946	7/16-18	2¼	9.89	100
JBHC97PL	78947	7/16-18	2½	10.02	100
JBHC106PL	78948	7/16-18	2¾	11.25	100
JBHC98PL	78949	7/16-18	3	12.75	100
JBHC99PL	78950	7/16-18	3½	15.66	100
JBHC107PL	78951	7/16-18	4	17.66	100
JBHC86PL	78952	½-13	¾	7.39	100
JBHC46PL	78953	½-13	1	4.25	50
JBHC47PL	78954	½-13	1½	5.52	50
JBHC65PL	78955	½-13	1¾	5.85	50
JBHC33PL	78956	½-13	2	6.85	50
JBHC66PL	78957	½-13	2¼	7.46	50
JBHC34PL	78958	½-13	2½	8.23	50
JBHC35PL	78959	½-13	3	9.50	50
JBHC36PL	78960	½-13	3½	5.57	25
JBHC37PL	78961	½-13	4	6.25	25
JBHC21PL	78962	5/8-11	1	7.79	50
JBHC108PL	78963	5/8-11	1¼	8.66	50
JBHC31PL	78964	5/8-11	1½	9.23	50
JBHC55PL	78965	5/8-11	1¾	10.37	50
JBHC69PL	78966	5/8-11	2	10.94	50
JBHC109PL	78967	5/8-11	2¼	12.09	50
JBHC71PL	78968	5/8-11	2½	13.30	50
JBHC72PL	78969	5/8-11	2¾	7.11	25
BHC73PL	78970	5/8-11	3	15.15	50
JBHC75PL	78971	5/8-11	3½	7.02	25
JBHC76PL	78972	5/8-11	4	9.18	25
JBHC78PL	78973	¾-10	1	5.80	25
JBHC110PL	78974	¾-10	1¼	6.89	25
BHC7612PL	78975	¾-10	1½	28.72	100
JBHC56PL	78976	¾-10	1¾	8.15	25
BHC77PL	78977	¾-10	2	24.00	100
BHC70PL	78978	¾-10	2¼	24.50	100
BHC79PL	78979	¾-10	2½	39.80	100
BHC111PL	78980	¾-10	2¾	44.20	100
BHC81PL	78981	¾-10	3	23.60	50
BHC83PL	78982	¾-10	3½	24.58	50

OTHER SIZES AND QUANTITIES AVAILABLE BY REQUEST

CONTINUED ON NEXT PAGE



CONTINUED



## HEX BOLTS

STEEL ZINC • PLAIN STEEL • GALVANIZED



PART#	UPC#	DIAMETER	LENGTH	WT. PER PKG.	STD. PKG. UM
<b>GALVANIZED</b>					
JBHC1G	85601	¼ -20	¾	1.57	100/500
JBHC2G	85602	¼ -20	1	1.85	100/500
JBHC49G	73012	¼ -20	1¼	2.13	100/500
JBHC3G	73013	¼ -20	1½	2.51	100
JBHC4G	73014	¼ -20	2	3.17	100
JBHC51G	73015	¼ -20	2¼	3.61	100
JBHC5G	85605	¼ -20	2½	3.91	100
JBHC6G	73016	¼ -20	3	4.47	100
JBHC7G	73017	¼ -20	3½	3.94	100
JBHC8G	73018	¼ -20	4	5.97	100
JBHC44G	85644	⅜ -16	¾	3.70	100
JBHC45G	85645	⅜ -16	1	4.83	100
JBHC59G	85659	⅜ -16	1¼	4.97	100
JBHC23G	85623	⅜ -16	1½	5.83	100
JBHC24G	85624	⅜ -16	2	7.18	100
JBHC61G	73019	⅜ -16	2¼	7.98	100
JBHC25G	73020	⅜ -16	2½	4.41	50
JBHC26G	73021	⅜ -16	3	5.21	50
JBHC27G	73022	⅜ -16	3½	6.05	50
JBHC28G	73023	⅜ -16	4	6.78	50
JBHC30G	85630	⅜ -16	5	8.70	50
JBHC42G	85642	⅝ -18	¾	2.57	100
JBHC103G	82198	⅝ -18	1	3.45	100/500
JBHC13G	82199	⅝ -18	1½	5.21	100
JBHC14G	82200	⅝ -18	2	6.29	100
JBHC46G	85646	½ -13	1	4.39	50
JBHC64G	73024	½ -13	1¼	4.85	50
JBHC47G	85647	½ -13	1½	5.46	50
JBHC33G	85599	½ -13	2	6.79	50
JBHC66G	73025	½ -13	2¼	7.51	50
JBHC34G	73026	½ -13	2½	8.28	50
BHC33G	15154	½ -13	2½	8.15	50
JBHC35G	85635	½ -13	3	9.92	50
JBHC36G	85636	½ -13	3½	7.43	25
JBHC37G	73027	½ -13	4	6.28	25
BHC12612G	82132	½ -13	6½	10.07	25
BHC103G	15380	½ -13	12	16.90	25
BHC69G	15138	⅝ -11	2	5.54	25
BHC71G	15133	⅝ -11	2½	7.52	25
BHC73G	15184	⅝ -11	3	8.00	25
BHC80G	82201	⅝ -11	5	12.41	25
BHC82G	75182	⅝ -11	6	12.88	25
JBHC78G	75178	¾ -10	1	5.93	25
BHC81G	82138	¾ -10	3	23.50	50
BHC3410G	82134	¾ -10	10	33.90	25
BHC7810G	82136	7/8 -9	10	42.46	25
BHC183G	15130	1-8	3	16.90	10

OTHER SIZES AND QUANTITIES AVAILABLE BY REQUEST



## GRADE 5 HEX BOLTS

DOMESTIC USA • STEEL ZINC • GALVANIZED



PART#	UPC#	DIAMETER	LENGTH	WT. PER PKG.	STD. PKG. UM
<b>DOMESTIC USA STEEL ZINC</b>					
JG5HC1D	71507	¼ -20	¾	1.49	100/500
JG5HC2D	71508	¼ -20	1	1.75	100/500
JG5HC49D	89767	¼ -20	1¼	2.15	100/500
JG5HC3D	89700	¼ -20	1½	2.44	100
JG5HC50CAN	82841	¼ -20	1¾	2.58	100
JG5HC88D	63420	¾ -16	½	2.88	100/500
JG5HC44D	81434	¾ -16	¾	3.51	100/500
JG5HC45D	82542	¾ -16	1	4.19	100
JG5HC59D	63419	¾ -16	1¼	4.84	100
JG5HC23D	81432	¾ -16	1½	5.53	100
JG5HC24D	81433	¾ -16	2	7.20	100
JG5HC25D	82096	¾ -16	2½	4.41	50
JG5HC26D	71526	¾ -16	3	5.20	50
JG5HC62D	89766	⅝ -11	1½	4.65	50
G5HC72D	61872	⅝ -11	4	10.00	25
JG5HC64D	82093	½ -13	1¼	9.46	100
JG5HC47D	81436	½ -13	1½	5.41	50
JG5HC33D	24353	½ -13	2	7.03	50
JG5HC47D	81436	½ -13	1½	5.41	50
G5HC77D	82547	¾ -10	1	10.60	100
<b>STEEL ZINC</b>					
JG5HC11	80656	¼ -20	½	1.25	100/500
JG5HC1	80657	¼ -20	¾	1.49	100/500
JG5HC21	82099	¼ -20	7/8	1.62	100/500
JG5HC2	80658	¼ -20	1	1.75	100/500
G5HC2M	13798	¼ -20	1	17.50	1000
JG5HC49	80659	¼ -20	1¼	2.15	100/500
JG5HC3	80660	¼ -20	1½	2.44	100
JG5HC4	80661	¼ -20	2	3.17	100
JG5HC5	80662	¼ -20	2½	4.22	100
JG5HC6	80663	¼ -20	3	4.62	100
JG5HC7	80664	¼ -20	3½	5.16	100
JG5HC8	80665	¼ -20	4	5.94	100
JG5HCF11	89611	¼ -28	½	1.23	100/500
<b>DOMESTIC USA STEEL ZINC</b>					
JG5HTB2D	83292	¼ -20	1	1.75	100
JG5HTB49D	83291	¼ -20	1¼	2.08	100
JG5HTB3D	83290	¼ -20	1½	2.35	100
JG5HTB4D	83289	¼ -20	2	2.85	100
<b>STEEL ZINC</b>					
JG5HCF1	89601	¼ -28	¾	1.53	100/500
JG5HCF12	89612	¼ -28	1	1.86	100/500
JG5HCF3	89603	¼ -28	1½	2.46	100
JG5HCF4	89604	¼ -28	2	3.07	100
JG5HC19	82097	5/16 -18	½	2.00	100/500
JG5HC42	80666	5/16 -18	¾	2.45	100/500
JG5HC41	83280	5/16 -18	7/8	2.92	100/500
JG5HC43	80667	5/16 -18	1	2.85	100/500
JG5HC54	82847	5/16 -18	1¼	3.32	100
JG5HC13	80668	5/16 -18	1½	3.87	100
JG5HC90	89490	5/16 -18	1¾	4.28	100
JG5HC14	80669	5/16 -18	2	4.97	100
JG5HC15	80670	5/16 -18	2½	6.10	100
JG5HC16	80671	5/16 -18	3	7.11	100

OTHER SIZES AND QUANTITIES AVAILABLE BY REQUEST

CONTINUED

## GRADE 5 HEX BOLTS

DOMESTIC USA • STEEL ZINC • GALVANIZED



PART#	UPC#	DIAMETER	LENGTH	WT. PER PKG.	STD. PKG. UM
<b>STEEL ZINC</b>					
JG5HC18	80672	5/16 - 18	3½	4.28	50
JG5HC20	80673	5/16 - 18	4	4.72	50
JG5HCF42	89642	5/16 - 24	¾	2.46	100/500
JG5HCF43	89643	5/16 - 24	1	2.91	100/500
JG5HCF50	89650	5/16 - 24	1¼	3.32	100
JG5HCF13	89613	5/16 - 24	1½	3.93	100
JG5HCF14	89614	5/16 - 24	2	5.00	100
JG5HCF15	89615	5/16 - 24	2½	3.12	50
JG5HC88	80674	3/8 - 16	½	2.88	100/500
JG5HC58	82851	3/8 - 16	5/8	3.20	100/500
JG5HC44	80675	3/8 - 16	¾	3.51	100/500
JG5HC45	80676	3/8 - 16	1	4.19	100
JG5HC59	80677	3/8 - 16	1¼	4.84	100
JG5HC23	80678	3/8 - 16	1½	5.53	100
JG5HC30	82830	3/8 - 16	1¾	6.12	100
JG5HC24	80679	3/8 - 16	2	7.36	100
JG5HC29	82827	3/8 - 16	2¼	7.82	100
JG5HC25	80680	3/8 - 16	2½	4.41	50
JG5HC31	82831	3/8 - 16	2¾	5.00	50
JG5HC26	80681	3/8 - 16	3	5.20	50
JG5HC27	82825	3/8 - 16	3½	5.91	50
JG5HC28	82826	3/8 - 16	4	6.87	50
G5HC40	13866	3/8 - 16	4½	6.66	50
JG5HCF44	89644	3/8 - 24	¾	3.52	100/500
JG5HCF45	89645	3/8 - 24	1	4.20	100
JG5HCF59	89659	3/8 - 24	1¼	4.84	100
JG5HCF23	89623	3/8 - 24	1½	5.58	100
JG5HC119	76219	7/16 - 14	1	3.11	50
JG5HC123	76223	7/16 - 14	1¼	3.38	50
JG5HC120	82098	7/16 - 14	1½	3.86	50
JG5HC121	76221	7/16 - 14	2	4.99	50
JG5HC122	76222	7/16 - 14	2½	6.68	50
JG5HC127	13887	7/16 - 14	3	4.98	50
JG5HCF95	89695	7/16 - 20	1½	8.01	100
JG5HCF86	89686	7/16 - 20	3	7.24	50
JG5HC81	82881	½ - 13	¾	3.73	50
JG5HC46	80682	½ - 13	1	4.23	50
JG5HC64	80683	½ - 13	1¼	4.73	50
JG5HC47	80684	½ - 13	1½	5.41	50
JG5HC32	82832	½ - 13	1¾	5.94	50
JG5HC33	80685	½ - 13	2	7.03	50
JG5HC12	82083	½ - 13	2¼	7.52	50
JG5HC34	80686	½ - 13	2½	8.11	50
JG5HC67	80687	½ - 13	2¾	8.87	50
JG5HC35	80688	½ - 13	3	9.14	50
JG5HC36	80689	½ - 13	3½	5.40	25
JG5HC37	82837	½ - 13	4	5.94	25
G5HC39	40039	½ - 13	4½	7.06	25
G5HC38	82839	½ - 13	5	7.59	25
G5HC48	13869	½ - 13	5½	8.41	25
JG5HCF97	89697	½ - 20	2½	4.37	25
JG5HC60	82853	5/8 - 11	1	3.78	25
JG5HC61	82854	5/8 - 11	1¼	8.47	50

\*PLAIN STEEL – OTHER SIZES AND QUANTITIES AVAILABLE BY REQUEST



CONTINUED

**GRADE 5 HEX BOLTS**

DOMESTIC USA • STEEL ZINC • GALVANIZED



PART#	UPC#	DIAMETER	LENGTH	WT. PER PKG.	STD. PKG. UM
<b>STEEL ZINC</b>					
JG5HC62	80690	5/8 - 11	1½	9.26	50
JG5HC69	82863	5/8 - 11	1¾	10.21	50
JG5HC63	80691	5/8 - 11	2	11.07	50
G5HC63B	13861	5/8 - 11	2	21.25	175
JG5HC124	76224	5/8 - 11	2¼	6.19	25
JG5HC66	82859	5/8 - 11	2½	13.30	50
JG5HC22	89622	5/8 - 11	2¾	7.45	25
JG5HC68	82862	5/8 - 11	3	7.83	25
JG5HC125	76225	5/8 - 11	3¼	8.37	25
G5HC70	13865	5/8 - 11	3½	10.80	50
JG5HC72	82872	5/8 - 11	4	10.00	25
JG5HC73	82873	5/8 - 11	4½	11.03	25
JG5HC75	82875	5/8 - 11	5	12.12	25
G5HC74	13871	¾ - 10	1½	5.30	50
JG5HC76	82874	¾ - 10	2	8.64	25
G5HC76	13874	¾ - 10	2	17.08	50
G5HC146	13891	¾ - 10	2¼	18.30	50
JG5HC78	82877	¾ - 10	2½	9.97	25
G5HC80	13880	¾ - 10	3	23.42	50
G5HC143	13888	¾ - 10	3¼	12.67	25
G5HC82	13883	¾ - 10	3½	27.85	50
G5HC144	13889	¾ - 10	3¾	29.12	50
JG5HC84	13886	¾ - 10	4	2.62	10
G5HC145	13890	¾ - 10	4½	32.20	50
JG5HC85	82885	¾ - 10	5	2.86	10
G5HC156	13897	7/8 - 9	2¼	14.46	25
G5HC153	13894	7/8 - 9	3¼	17.85	25
G5HC154	13895	7/8 - 9	4	17.92	25
G5HC155	13896	7/8 - 9	5	19.21	25
<b>PLAIN STEEL</b>					
*G5HC13P	13796	5/16 - 18	1½	38.00	1000
<b>GALVANIZED</b>					
JG5HC60G	73060	5/8 - 11	1	3.81	25
JG5HC61G	73061	5/8 - 11	1¼	8.49	50

OTHER SIZES AND QUANTITIES AVAILABLE BY REQUEST



**GRADE 5 HEX TAP BOLTS**

DOMESTIC USA • STEEL ZINC

Fully Threaded



PART#	UPC#	DIAMETER	LENGTH	WT. PER PKG.	STD. PKG. UM
<b>STEEL ZINC</b>					
JG5HTB1	28645	¼ - 20	¾	1.50	100
JG5HTB2	64302	¼ - 20	1	1.75	100
JG5HTB49	28646	¼ - 20	1¼	2.08	100
JG5HTB3	28647	¼ - 20	1½	2.35	100
JG5HTB50	28648	¼ - 20	1¾	2.58	100
JG5HTB4	28649	¼ - 20	2	2.85	100
JG5HTB51	28650	¼ - 20	2¼	3.08	100
JG5HTB5	28651	¼ - 20	2½	3.40	100
JG5HTB52	28652	¼ - 20	2¾	3.68	100
JG5HTB6	28653	¼ - 20	3	4.02	100
JG5HTB53	28654	¼ - 20	3¼	4.20	100

OTHER SIZES AND QUANTITIES AVAILABLE BY REQUEST

CONTINUED ON NEXT PAGE



## GRADE 5 HEX TAP BOLTS

DOMESTIC USA • STEEL ZINC

Fully  
Threaded



PART#	UPC#	DIAMETER	LENGTH	WT. PER PKG.	STD. PKG. UM
<b>STEEL ZINC</b>					
JG5HTB7	28655	¼ -20	3½	4.48	100
JG5HTB8	28656	¼ -20	4	4.93	100
JG5HTB22	28657	¼ -20	4½	2.76	50
JG5HTB9	28658	¼ -20	5	5.86	100
JG5HTB10	28659	¼ -20	5½	6.56	100
JG5HTB17	28660	¼ -20	6	7.04	100
JG5HTB43	28661	5/16 -18	1	2.86	100
JG5HTB54	28662	5/16 -18	1¼	3.27	100
JG5HTB13	28663	5/16 -18	1½	3.74	100
JG5HTB90	28664	5/16 -18	1¾	4.13	100
JG5HTB14	28665	5/16 -18	2	4.54	100
JG5HTB91	28666	5/16 -18	2¼	5.00	100
JG5HTB15	28667	5/16 -18	2½	5.43	100
JG5HTB39	28668	5/16 -18	2¾	5.88	100
JG5HTB16	28669	5/16 -18	3	6.24	100
JG5HTB64	28670	5/16 -18	3¼	6.69	100
JG5HTB69	28671	5/16 -18	3½	7.13	100
JG5HTB20	28672	5/16 -18	4	7.94	100
JG5HTB55	28673	5/16 -18	4½	4.42	50
JG5HTB221	28674	5/16 -18	5	5.79	100
JG5HTB99	28675	5/16 -18	5½	6.30	100
JG5HTB101	19833	5/16 -18	6	5.76	50
JG5HTB44	28710	3/8 -16	¾	3.59	100
JG5HTB59	28677	3/8 -16	1¼	4.80	100
JG5HTB23	64323	3/8 -16	1½	5.39	100
JG5HTB30	28679	3/8 -16	1¾	6.07	100
JG5HTB24	28680	3/8 -16	2	6.71	100
JG5HTB29	28681	3/8 -16	2¼	7.29	100
JG5HTB25	28682	3/8 -16	2½	7.91	100
JG5HTB31	28683	3/8 -16	2¾	4.75	100
JG5HTB26	28684	3/8 -16	3	9.08	100
JG5HTB2650	28687	3/8 -16	3	4.54	50
JG5HTB102	28685	3/8 -16	3¼	9.75	100
JG5HTB27	28690	3/8 -16	3½	5.35	50
JG5HTB104	28707	3/8 -16	3¾	5.41	50
JG5HTB28	28691	3/8 -16	4	5.87	50
JG5HTB105	28708	3/8 -16	4½	6.50	50
JG5HTB106	28692	3/8 -16	5	7.08	50
JG5HTB107	28709	3/8 -16	5½	7.72	50
JG5HTB108	28693	3/8 -16	6	8.44	50
JG5HTB79	28711	½ -13	1¼	4.85	50
JG5HTB88	28712	½ -13	1½	5.40	50
JG5HTB47	64347	½ -13	1¾	6.00	50
G5HTB47V	30347	½ -13	1¾	60.00	500
JG5HTB33	28714	½ -13	2	6.55	50
JG5HTB12	28701	½ -13	2¼	7.09	50
JG5HTB34	28715	½ -13	2½	7.64	50
JG5HTB67	28716	½ -13	2¾	8.87	50
JG5HTB35	28717	½ -13	3	8.99	50
JG5HTB36	28718	½ -13	3½	9.89	50
JG5HTB37	28702	½ -13	4	5.57	25
JG5HTB38	28719	½ -13	5	6.78	25
JG5HTB40	28703	½ -13	5½	7.34	25
JG5HTB77	28720	½ -13	6	10.12	25

OTHER SIZES AND QUANTITIES AVAILABLE BY REQUEST



CONTINUED  
**GRADE 5 HEX TAP BOLTS**  
 DOMESTIC USA • STEEL ZINC

Fully  
Threaded



PART#	UPC#	DIAMETER	LENGTH	WT. PER PKG.	STD. PKG. UM
<b>STEEL ZINC</b>					
G5HTB63	28704	5/8 -11	2	11.08	50
JG5HTB65	72688	5/8 -11	2¼	11.84	50
G5HTB66	28721	5/8 -11	2½	12.83	50
JG5HTB66	72689	5/8 -11	2½	2.66	10
G5HTB68	28694	5/8 -11	3	14.77	50
JG5HTB68	82871	5/8 -11	3	7.23	25
G5HTB77	28722	5/8 -11	3¼	15.34	50
JG5HTB70	84319	5/8 -11	3½	5.40	25
JG5HTB71	84311	5/8 -11	3¾	8.69	25
G5HTB72	28698	5/8 -11	4	18.15	50
JG5HTB72	84342	5/8 -11	4	10.00	25
G5HTB73	28723	5/8 -11	4½	19.83	50
G5HTB75	28697	5/8 -11	5	21.30	50
G5HTB79	28699	5/8 -11	5½	23.39	50
G5HTB80	<b>28700</b>	<b>5/8 -11</b>	<b>6</b>	<b>25.36</b>	<b>50</b>

OTHER SIZES AND QUANTITIES AVAILABLE BY REQUEST



**GRADE 8 HEX BOLTS**  
 STEEL ZINC



PART#	UPC#	DIAMETER	LENGTH	WT. PER PKG.	STD. PKG. UM
<b>GRADE 8 STEEL ZINC</b>					
JG8HC7	83225	¼ -20	½	1.24	100/500
JG8HC18	68806	¼ -20	5/8	1.32	100/500
JG8HC1	80698	¼ -20	¾	1.53	100/500
JG8HC2	80699	¼ -20	1	1.74	100/500
JG8HC114	90555	¼ -20	1¼	2.10	100/500
JG8HC3	80700	¼ -20	1½	2.44	100/500
JG8HC71	83227	¼ -20	1¾	2.81	100/500
JG8HC4	80701	¼ -20	2	3.21	100
JG8HC72	83228	¼ -20	2¼	3.54	100
JG8HC5	80702	¼ -20	2½	1.99	50
JG8HC75	97026	¼ -20	2¾	4.04	100
JG8HC6	80703	¼ -20	3	2.28	50
JG8HC73	83229	¼ -20	3½	2.70	50
JG8HC8	83216	¼ -20	4	2.95	50
JG8HC74	83230	¼ -20	4½	3.37	50
JG8HC40	83215	5/16 -18	½	2.02	100/500
JG8HC42	80704	5/16 -18	¾	2.46	100/500
JG8HC17	83235	5/16 -18	7/8	2.65	100/500
JG8HC43	80705	5/16 -18	1	2.87	100/500
JG8HC414	90585	5/16 -18	1¼	3.27	100/500
JG8HC13	80706	5/16 -18	1½	3.93	100
JG8HC413	83218	5/16 -18	1¾	4.48	100
JG8HC415	83220	5/16 -18	2	2.50	50
JG8HC14	80707	5/16 -18	2	5.00	100
JG8HC417	83222	5/16 -18	2¼	2.95	50
JG8HC15	80708	5/16 -18	2½	3.10	50
JG8HC418	83223	5/16 -18	2¾	6.60	50
JG8HC16	83234	5/16 -18	3	3.67	50
JG8HC416	83221	5/16 -18	3½	4.21	50
JG8HC20	83237	5/16 -18	4	4.56	50

OTHER SIZES AND QUANTITIES AVAILABLE BY REQUEST



CONTINUED

## GRADE 8 HEX BOLTS STEEL ZINC



PART#	UPC#	DIAMETER	LENGTH	WT. PER PKG.	STD. PKG. UM
<b>GRADE 8 STEEL ZINC</b>					
JG8HC19	83236	3/8-16	1/2	2.95	100/500
JG8HC2334	80710	3/8-16	3/4	3.59	100/500
JG8HC231	80711	3/8-16	1	4.36	100
JG8HC214	90565	3/8-16	1 1/4	4.91	100
JG8HC23	80712	3/8-16	1 1/2	5.58	100
JG8HC30	83247	3/8-16	1 3/4	3.17	50
JG8HC24	80713	3/8-16	2	3.62	50
JG8HC31	83212	3/8-16	2 1/4	4.03	50
JG8HC25	80714	3/8-16	2 1/2	4.37	50
JG8HC12	83211	3/8-16	2 3/4	4.72	100
JG8HC26	83255	3/8-16	3	5.06	50
JG8HC32	83213	3/8-16	3 1/2	6.11	50
JG8HC28	83258	3/8-16	4	6.60	50
JG8HC39	83214	3/8-16	4 1/2	7.09	50
JG8HC232	68810	3/8-24	1 1/2	5.85	100
JG8HC241	68812	3/8-24	2	7.42	100
JG8HC251	68814	3/8-24	2 1/2	9.00	100
JG8HC261	68816	3/8-24	3	6.08	50
JG8HC262	68818	3/8-24	3 1/2	6.49	50
JG8HC281	68820	3/8-24	4	6.89	50
JG8HC76	90644	7/16-14	3/4	5.01	100
JG8HC768	83233	7/16-14	3/4	5.27	100
JG8HC761	90650	7/16-14	1	1.49	25
JG8HC76114	90647	7/16-14	1 1/4	1.68	25
JG8HC76112	90645	7/16-14	1 1/2	1.92	25
JG8HC76134	83244	7/16-14	1 3/4	2.29	100
JG8HC762	90651	7/16-14	2	2.50	25
JG8HC76214	83253	7/16-14	2 1/4	2.72	25
JG8HC764	83231	7/16-14	2 1/2	3.02	25
JG8HC765	83232	7/16-14	2 3/4	3.33	25
JG8HC763	90652	7/16-14	3	2.42	50
JG8HC766	83240	7/16-14	3 1/2	4.12	25
JG8HC767	83241	7/16-14	4	4.63	25
JG8HC45	90601	1/2-13	3/4	3.76	100
JG8HC46	83261	1/2-13	1	4.24	50
JG8HC48	83287	1/2-13	1 1/4	9.49	100
JG8HC47	81037	1/2-13	1 1/2	2.73	25
JG8HC49	83562	1/2-13	1 3/4	2.96	25
JG8HC33	83267	1/2-13	2	3.36	25
JG8HC66	90495	1/2-13	2 1/4	3.81	25
JG8HC34	83270	1/2-13	2 1/2	4.08	25
JG8HC50	83265	1/2-13	2 3/4	4.35	25
JG8HC35	83273	1/2-13	3	4.66	25
JG8HC36	83274	1/2-13	3 1/2	5.66	25
JG8HC37	83276	1/2-13	4	5.81	25
JG8HC38	83277	1/2-13	4 1/2	6.80	25
JG8HC331	68836	1/2-20	2	3.49	25
JG8HC341	68838	1/2-20	2 1/2	4.23	25
JG8HC351	68840	1/2-20	3	4.92	25
JG8HC361	68842	1/2-20	3 1/2	5.53	25
JG8HC371	68844	1/2-20	4	6.29	25
JG8HC21	83238	5/8-11	1	3.76	25
JG8HC22	83239	5/8-11	1 1/4	4.11	25/125

OTHER SIZES AND QUANTITIES AVAILABLE BY REQUEST



CONTINUED



## GRADE 8 HEX BOLTS

STEEL ZINC



PART#	UPC#	DIAMETER	LENGTH	WT. PER PKG.	STD. PKG. UM
<b>GRADE 8 STEEL ZINC</b>					
JG8HC27	83256	5/8-11	1½	4.47	25
JG8HC29	83259	5/8-11	1¾	4.83	25
JG8HC582	71501	5/8-11	2	5.54	25
JG8HC58214	90633	5/8-11	2¼	6.08	25
JG8HC58212	90634	5/8-11	2½	6.65	25
JG8HC58234	90635	5/8-11	2¾	7.09	25
G8HC583	15430	5/8-11	3	7.73	25
JG8HC58314	90616	5/8-11	3¼	8.05	25
G8HC58312	83297	5/8-11	3½	8.37	25
JG8HC58334	90618	5/8-11	3¾	9.22	25
G8HC584	15431	5/8-11	4	10.08	25
G8HC58412	15435	5/8-11	4½	16.23	25
G8HCF83	16983	5/8-18	3	8.11	25
G8HC751	90701	¾-10	1	12.15	50
G8HC75114	90702	¾-10	1¼	13.78	50
G8HC75112	90703	¾-10	1½	5.30	50
G8HC75134	90704	¾-10	1¾	8.09	25/125
G8HC752	90705	¾-10	2	8.54	25
G8HC75214	90706	¾-10	2¼	9.15	25
G8HC340	90577	¾-10	2½	8.97	25
G8HC75234	90708	¾-10	2¾	9.06	25
G8HC343	90581	¾-10	3	11.60	25
G8HC34312	90582	¾-10	3½	13.15	25
G8HC754	90710	¾-10	4	11.87	20
G8HC34712	86385	¾-10	7½	25.54	25
G8HC344	90583	¾-16	2½	10.27	25
G8HC345	90587	¾-16	3	12.02	25
G8HC346	90590	¾-16	4	15.19	25
JG8HC71	83227	1-14	2	7.24	100
JG8HC72	83228	1-14	3	9.23	100
G8HC441	90593	1-14	3½	10.35	10
G8HC442	90598	1-14	4	11.60	10

OTHER SIZES AND QUANTITIES AVAILABLE BY REQUEST



## HEX BOLTS

DOMESTIC USA 18-8 STAINLESS • 316 STAINLESS



PART#	UPC#	DIAMETER	LENGTH	WT. PER PKG.	STD. PKG. UM
<b>DOMESTIC 18-8 STAINLESS</b>					
JSBH11D	94801	¼-20	½	1.23	100
JSBH5D	94807	¼-20	5/8	1.34	100
JSBH1D	95240	¼-20	¾	1.49	100
JSBH78D	93890	¼-20	7/8	1.62	100
JSBH2D	94802	¼-20	1	1.75	100
JSBH49D	93400	¼-20	1¼	2.12	50
JSBH3D	94802	¼-20	1½	2.44	100
JSBH36D	94805	¼-20	1¾	2.80	100
JSBH4D	94806	¼-20	2	3.23	100
JSBH51D	94808	¼-20	2¼	3.64	100
JSBH41D	94497	¼-20	2½	3.89	100
JSBH412D	94498	¼-20	3	4.66	100
JSBH413D	94498	¼-20	3½	5.42	100

OTHER SIZES AND QUANTITIES AVAILABLE BY REQUEST

CONTINUED ON NEXT PAGE

CONTINUED



## HEX BOLTS

DOMESTIC USA 18-8 STAINLESS • 316 STAINLESS



PART#	UPC#	DIAMETER	LENGTH	WT. PER PKG.	STD. PKG. UM
<b>DOMESTIC 18-8 STAINLESS</b>					
JSBH44D	94200	3/8-16	3/4	1.79	50
JSBH45D	94894	3/8-16	1	4.19	100
JSBH59D	94895	3/8-16	1 1/4	4.87	100
JSBH23D	94896	3/8-16	1 1/2	5.65	100
JSBH27D	94897	3/8-16	1 3/4	6.47	100
JSBH24D	94898	3/8-16	2	7.24	100
JSBH31D	93896	3/8-16	2 1/4	8.12	100
JSBH25D	93897	3/8-16	2 1/2	4.12	50
JSBH26D	93898	3/8-16	3	5.23	50
JSBH28D	93899	3/8-16	3 1/2	5.96	50
JSBH81D	92823	1/2-13	3/4	3.61	50
JSBH46D	95238	1/2-13	1	4.39	50
JSBH64D	83674	1/2-13	1 1/4	4.80	50
JSBH47D	94242	1/2-13	1 1/2	5.44	50
JSBH65D	95244	1/2-13	1 3/4	5.94	50
JSBH33D	95245	1/2-13	2	6.85	50
JSBH39D	92828	1/2-13	2 1/4	6.91	50
JSBH34D	92829	1/2-13	2 1/2	8.20	50
JSBH35D	92830	1/2-13	3	9.48	50
<b>DOMESTIC 316 STAINLESS</b>					
JSBH231D	65431	1/4-20	3/4	1.50	100/500
JSBH234D	65434	1/4-20	1	1.78	100/500
JSBH236D	65436	1/4-20	1 1/2	2.52	100
JSBH252D	98301	3/8-16	1	4.20	100
<b>18-8 STAINLESS</b>					
JSBH101	83564	10-24	1/2	.74	100/500
JSBH10	83574	10-32	1/2	.62	100
JSBH9	83573	10-32	3/4	.79	100/500
JSBH178	96378	10-32	7/8	.86	100/500
JSBH7	83571	10-32	1 1/2	1.02	100/500
JSBH97	83668	1/4-20	3/8	1.17	100/500
JSBH11	80719	1/4-20	1/2	1.23	100/500
JSBH5	83569	1/4-20	5/8	1.34	100/500
JSBH1	80720	1/4-20	3/4	1.49	100/500
SBH1M	22780	1/4-20	3/4	14.70	1000
JSBH2	80721	1/4-20	1	1.75	100/500
JSBH49	80722	1/4-20	1 1/4	2.12	100/500
JSBH3L	69203	1/4-20	1 1/2	1.27	50
JSBH3	80723	1/4-20	1 1/2	2.44	100/500
JSBH36	83600	1/4-20	1 3/4	2.80	100
JSBH4L	69204	1/4-20	2	1.62	50
JSBH4	83568	1/4-20	2	3.23	100
JSBH51	83615	1/4-20	2 1/4	3.64	100
JSBH41	83605	1/4-20	2 1/2	3.89	100
JSBH412	93312	1/4-20	3	4.66	100
JSBH413	93313	1/4-20	3 1/2	5.42	100
JSBH55	80871	1/4-20	4	6.18	100
JSBH202	90459	1/4-28	3/8	1.14	100/500
JSBH200	90460	1/4-28	1/2	1.29	100/500
JSBH201	90461	1/4-28	3/4	1.62	100/500
JSBH203	90462	1/4-28	1	1.85	100/500
JSBH204	90463	1/4-28	1 1/4	2.18	100/500
JSBH205	90464	1/4-28	1 1/2	2.53	100

OTHER SIZES AND QUANTITIES AVAILABLE BY REQUEST



CONTINUED

## HEX BOLTS

DOMESTIC USA • 18-8 STAINLESS • 316 STAINLESS



PART#	UPC#	DIAMETER	LENGTH	WT. PER PKG.	STD. PKG. UM
<b>18-8 STAINLESS</b>					
JSBH206	90465	¼-28	2	3.22	100
JSBH207	90468	¼-28	2½	3.91	100
JSBH86	80724	5/16-18	½	2.03	100/500
JSBH42	80725	5/16-18	¾	2.41	100/500
JSBH43	80726	5/16-18	1	2.85	100/500
JSBH54	80727	5/16-18	1¼	3.28	100/500
JSBH13	80728	5/16-18	1½	3.92	100
JSBH12	80729	5/16-18	1¾	4.50	100
JSBH14	80730	5/16-18	2	5.01	100
JSBH15	80731	5/16-18	2½	6.14	100
JSBH16	80732	5/16-18	3	7.14	100
JSBH17	80733	5/16-18	3½	8.30	100
JSBH300	94100	5/16-24	¾	2.53	100/500
JSBH301	94101	5/16-24	1	2.97	100/500
JSBH302	94102	5/16-24	1¼	3.42	100/500
JSBH303	94103	5/16-24	1½	4.05	100
JSBH304	94104	5/16-24	2	5.15	100
JSBH305	94105	5/16-24	2½	6.26	100
SBH16B	15916	5/16-24	3	71.40	2500
JSBH88	80734	3/8-16	½	2.94	100/500
JSBH44	80735	3/8-16	¾	3.57	100
JSBH48	80736	3/8-16	7/8	3.83	100
JSBH45	80737	3/8-16	1	4.19	100
JSBH59	80738	3/8-16	1¼	4.87	100
JSBH23	80739	3/8-16	1½	5.72	100
JSBH27	83591	3/8-16	1¾	6.47	100
JSBH24	80740	3/8-16	2	7.24	100
JSBH31	82595	3/8-16	2¼	8.12	100
JSBH25	83589	3/8-16	2½	4.12	50
JSBH73	83637	3/8-16	2¾	9.45	100
JSBH26	83590	3/8-16	3	5.23	50
JSBH28	83592	3/8-16	3½	5.96	50
JSBH29	83593	3/8-16	4	6.77	50
JSBH30	83594	3/8-16	5	8.39	50
JSBH32	83596	3/8-16	6	9.51	50
JSBH400	93300	3/8-24	¾	3.69	100
JSBH401	93301	3/8-24	1	4.31	100
JSBH402	93302	3/8-24	1¼	5.06	100
JSBH232	98232	3/8-24	1½	2.98	50
JSBH403	93303	3/8-24	1½	5.81	100
JSBH241	98241	3/8-24	2	3.76	50
JSBH404	93304	3/8-24	2	7.41	100
JSBH405	93305	3/8-24	2½	9.05	100
JSBH250	98250	3/8-24	2½	4.54	50
JSBH261	68792	3/8-24	3	5.33	50
JSBH281	98281	3/8-24	3½	6.08	50
JSBH406	93306	3/8-24	3½	11.94	100
JSBH291	68796	3/8-24	4	6.87	50
JSBH71	83635	7/16-14	1	5.72	100
JSBH22	83586	7/16-14	1¼	6.71	100
JSBH82	83646	7/16-14	1½	8.18	100
JSBH501	94301	7/16-14	1¾	4.44	50
JSBH502	94302	7/16-14	2	6.02	50

OTHER SIZES AND QUANTITIES AVAILABLE BY REQUEST

CONTINUED ON NEXT PAGE

[www.metallics.us](http://www.metallics.us)



CONTINUED

## HEX BOLTS

DOMESTIC USA • 18-8 STAINLESS • 316 STAINLESS



PART#	UPC#	DIAMETER	LENGTH	WT. PER PKG.	STD. PKG. UM
<b>18-8 STAINLESS</b>					
JSBH503	94303	7/16-14	2½	4.99	50
JSBH505	94305	7/16-14	3	5.11	50
JSBH74	83638	7/16-14	4	8.83	50
JSBH599	94399	7/16-20	¾	2.75	50/250
JSBH600	94600	7/16-20	1	3.08	50
JSBH601	94601	7/16-20	1¼	3.51	50
JSBH602	94602	7/16-20	1½	3.98	50
JSBH603	94603	7/16-20	1¾	4.56	50
JSBH604	94604	7/16-20	2	5.06	50
JSBH605	94605	7/16-20	2½	6.16	50
JSBH38	83602	½-13	½	7.21	100
JSBH81	80741	½-13	¾	7.22	100
JSBH46	80742	½-13	1	4.39	50
JSBH64	80743	½-13	1¼	4.80	50
JSBH47	80744	½-13	1½	5.44	50
JSBH65	80745	½-13	1¾	5.94	50
JSBH33	80746	½-13	2	6.85	50
JSBH39	90453	½-13	2¼	6.91	50
JSBH34	80747	½-13	2½	8.20	50
JSBH40	90455	½-13	2¾	9.10	50
SBH67	12353	½-13	2¾	18.20	100
JSBH35	80748	½-13	3	9.48	50
SBH325	94125	½-13	3¼	10.40	50
JSBH350	94150	½-13	3½	10.94	50
SBH357	94097	½-13	3¾	11.17	50
JSBH355	94155	½-13	4	12.31	50
SBH359	91459	½-13	4½	13.64	50
JSBH37	83601	½-13	5	7.21	25
JSBH19	83583	½-13	5½	8.32	25
JSBH700	94900	½-20	1	4.49	50
JSBH701	94901	½-20	1½	5.58	50
JSBH702	94902	½-20	2	7.02	50
JSBH703	94903	½-20	2½	8.45	50
JSBH704	94904	½-20	3	9.81	50
JSBH3581	68798	½-20	3½	11.33	50
JSBH3582	68799	½-20	4	12.68	50
JSBH913	95113	5/8-11	1	7.53	50
JSBH919	95119	5/8-11	1¼	7.66	50
JSBH912	95112	5/8-11	1½	9.28	50
JSBH914	95114	5/8-11	1¾	9.37	50
JSBH93	83665	5/8-11	2	10.99	50
JSBH94	83664	5/8-11	2½	13.16	50
SBH96	12396	5/8-11	3	15.90	50
JSBH799	94699	5/8-11	3¼	8.03	25
JSBH800	95000	5/8-11	3½	8.81	25
JSBH801	95001	5/8-11	4	9.99	25
JSBH808	95008	5/8-11	6	12.53	25
SBH99	12384	5/8-11	16	10.99	100
SBH91	12391	¾-10	1	24.75	100
SBH90	12390	¾-10	1½	26.63	100
SBH983	12533	¾-10	2	8.94	25
SBH9845	28545	¾-10	2½	19.74	50
SBH984	12534	¾-10	2½	8.47	20

OTHER SIZES AND QUANTITIES AVAILABLE BY REQUEST



CONTINUED

**HEX BOLTS**

DOMESTIC USA • 18-8 STAINLESS • 316 STAINLESS

PART#	UPC#	DIAMETER	LENGTH	WT. PER PKG.	STD. PKG. UM
<b>18-8 STAINLESS</b>					
SBH982	15999	3/4-10	3	23.53	20
SBH985	12535	3/4-10	3 1/2	11.22	20
SBH60	12327	3/4-10	3 3/4	28.12	50
SBH986	12536	3/4-10	4	12.40	20
SBH9865	28565	3/4-10	4	29.16	50
SBH987	12537	3/4-10	5	8.06	10
SBH988	12538	3/4-10	5 1/2	8.74	10
SBH989	12539	3/4-10	8	12.57	10
JSBH182	96382	1-8	2 3/4	20.62	25
JSBH181	96381	1-8	3 1/2	24.80	25
JSBH183	96383	1-8	4	27.36	25
<b>316 STAINLESS</b>					
JSBH231	98231	1/4-20	3/4	1.49	100
JSBH234	98234	1/4-20	1	1.77	100
JSBH491	93391	1/4-20	1 1/4	2.26	100
JSBH236	98236	1/4-20	1 1/2	2.52	100
JSBH238	98238	1/4-20	2	3.19	100
JSBH411	93311	1/4-20	2 1/2	3.82	100
JSBH611	94611	1/4-20	3	4.81	100
JSBH2371	68797	1/4-20	3 1/4	5.12	100
JSBH551	94351	1/4-20	4	6.11	100
JSBH421	93321	5/16-18	3/4	2.53	100
JSBH435	93335	5/16-18	1	2.85	100
JSBH541	94341	5/16-18	1 1/4	3.28	100
JSBH131	96331	5/16-18	1 1/2	3.92	100
JSBH142	96342	5/16-18	2	5.01	100
JSBH184	96384	5/16-18	3 1/4	8.30	100
JSBH171	83565	5/16-18	3 1/2	8.30	100
JSBH252	98252	3/8-16	1	4.20	100
JSBH253	98253	3/8-16	1 1/4	4.85	100
JSBH254	98254	3/8-16	1 1/2	5.71	100
JSBH255	98255	3/8-16	2	7.37	100
JSBH251	98251	3/8-16	2 1/2	4.13	50
JSBH126	83623	3/8-16	3	10.56	100
JSBH2561	68790	3/8-16	3 3/4	5.67	50
JSBH771	94971	3/8-16	4 1/2	7.52	50
SBH20	15920	3/8-16	6	12.13	50
JSBH552	94352	7/16-14	1	2.98	50
JSBH811	95011	1/2-13	3/4	7.46	100
JSBH332	94132	1/2-13	1	8.65	100
JSBH336	94136	1/2-13	1 1/4	9.71	100
JSBH337	94137	1/2-13	1 1/2	10.76	100
JSBH651	94651	1/2-13	1 3/4	6.02	50
JSBH339	94139	1/2-13	2	13.76	100
JSBH334	94134	1/2-13	2 1/4	7.51	50
JSBH341	94141	1/2-13	2 1/2	8.20	50
SBH671	12337	1/2-13	2 3/4	16.65	100
JSBH351	94151	1/2-13	3	9.81	50
JSBH356	94156	1/2-13	3 1/4	10.51	50
JSBH353	94153	1/2-13	3 1/2	11.22	50
JSBH354	94154	1/2-13	4	12.64	50
SBH355	12352	1/2-13	4 1/2	12.75	50

OTHER SIZES AND QUANTITIES AVAILABLE BY REQUEST

CONTINUED ON NEXT PAGE



CONTINUED  
**HEX BOLTS**

DOMESTIC USA • 18-8 STAINLESS • 316 STAINLESS

PART#	UPC#	DIAMETER	LENGTH	WT. PER PKG.	STD. PKG. UM
<b>316 STAINLESS</b>					
JSBH670	94670	5/8-11	1	3.83	25
JSBH671	94671	5/8-11	1¼	4.18	25
SBH672	12552	5/8-11	1½	4.68	25
SBH674	12554	5/8-11	2	5.59	25
SBH941	12480	5/8-11	2½	6.73	25
SBH943	12393	5/8-11	2¾	7.98	25
JSBH961	95161	5/8-11	3	7.78	25
SBH680	12490	5/8-11	3½	8.36	25
SBH805	10791	5/8-11	5	11.49	25
JSBH990	95190	¾-10	1	6.12	25
JSBH991	95191	¾-10	1½	7.42	25
JSBH992	95192	¾-10	2	8.78	25
SBH951	12475	¾-10	2½	10.03	25
SBH981	12470	¾-10	3	11.77	25
SBH760	12485	¾-10	3½	13.28	25
JSBH995	95195	¾-10	4	14.58	25

OTHER SIZES AND QUANTITIES AVAILABLE BY REQUEST



**HEX HEAD METRIC  
TAP BOLTS**

STEEL ZINC • 18-8 STAINLESS

Full  
Thread



PART#	UPC#	DIAMETER	LENGTH	CLASS	WT. PER PKG.	STD. PKG. UM
<b>STEEL ZINC</b>						
JMHTB38	64830	M3	8mm	8.8	.35	100
JMHTB310	64832	M3	10mm	8.8	.22	100
JMHTB312	84634	M3	12mm	8.8	.25	100
JMHTB316	64838	M3	16mm	8.8	.28	100
JMHTB320	64842	M3	20mm	8.8	.33	100
JMHTB48	64846	M4	8mm	8.8	.54	100
JMHTB410	64848	M4	10mm	8.8	.39	100
JMHTB412	64850	M4	12mm	8.8	.46	100
JMHTB416	64854	M4	16mm	8.8	.51	100
JMHTB420	64858	M4	20mm	8.8	.55	100
JMHTB425	64863	M4	25mm	8.8	.62	100
JMHTB430	84868	M4	30mm	8.8	.76	100
JMHTB58	84875	M5	8mm	8.8	.88	100
JMHTB510	84877	M5	10mm	8.8	.62	100
JMHTB512	64879	M5	12mm	8.8	.76	100
JMHTB516	64833	M5	16mm	8.8	.82	100
JMHTB520	64877	M5	20mm	8.8	.88	100
JMHTB525	64892	M5	25mm	8.8	.97	100
JMHTB530	64898	M5	30mm	8.8	1.14	100
JMHTB535	64902	M5	35mm	8.8	1.27	100
JMHTB540	64907	M5	40mm	8.8	1.43	100
JMHTB68	64912	M6	8mm	8.8	1.84	100
JMHTB610	64914	M6	10mm	8.8	1.00	100
JMHTB612	64916	M6	12mm	8.8	1.02	100
JMHTB616	64920	M6	16mm	8.8	1.17	100
JMHTB620	64924	M6	20mm	8.8	1.40	100
JMHTB625	64929	M6	25mm	8.8	1.52	100
JMHTB630	64934	M6	30mm	8.8	1.67	100

OTHER SIZES AND QUANTITIES AVAILABLE BY REQUEST

CONTINUED

## HEX HEAD METRIC TAP BOLTS

STEEL ZINC • 18-8 STAINLESS

Full  
Thread



PART#	UPC#	DIAMETER	LENGTH	CLASS	WT. PER PKG.	STD. PKG. UM
<b>STEEL ZINC</b>						
JMHTB635	64939	M6	35mm	8.8	1.98	100
JMHTB640	64944	M6	40mm	8.8	2.12	100
JMHTB645	64949	M6	45mm	8.8	2.80	100
JMHTB650	64954	M6	50mm	8.8	2.84	100
JMHTB810	64999	M8	10mm	8.8	2.00	100
JMHTB812	65001	M8	12mm	8.8	2.24	100
JMHTB816	63909	M8	16mm	8.8	2.36	100
JMHTB820	65009	M8	20mm	8.8	2.98	100
JMHTB825	65014	M8	25mm	8.8	2.99	100
JMHTB830	65019	M8	30mm	8.8	3.32	100
JMHTB835	65024	M8	35mm	8.8	3.75	100
JMHTB840	65029	M8	40mm	8.8	4.07	100
JMHTB845	65034	M8	45mm	8.8	4.62	100
JMHTB850	65039	M8	50mm	8.8	4.76	100
JMHTB860	63914	M8	60mm	8.8	5.45	100/500
JMHTB1012	65049	M10	12mm	8.8	1.20	50
JMHTB1016	65053	M10	16mm	8.8	1.38	50
JMHTB1020	65057	M10	20mm	8.8	2.46	50
JMHTB1025	65062	M10	25mm	8.8	2.69	50
JMHTB1030	65067	M10	30mm	8.8	2.98	50
JMHTB1035	65072	M10	35mm	8.8	3.25	50
JMHTB1040	65077	M10	40mm	8.8	3.52	50
JMHTB1045	65082	M10	45mm	8.8	3.79	50
JMHTB1050	65087	M10	50mm	8.8	4.05	50
JMHTB1055	65092	M10	55mm	8.8	4.37	50
JMHTB1060	65097	M10	60mm	8.8	4.68	50
JMHTB1070	65101	M10	70mm	8.8	5.26	50
JMHTB1216	65110	M12	16mm	8.8	3.19	50
JMHTB1220	65114	M12	20mm	8.8	3.34	50
JMHTB1225	65119	M12	25mm	8.8	3.52	50
JMHTB1230	65124	M12	30mm	8.8	3.70	50
JMHTB1235	65129	M12	35mm	8.8	3.89	50
JMHTB1240	65134	M12	40mm	8.8	4.21	50
JMHTB1245	65139	M12	45mm	8.8	5.56	50
JMHTB1250	65144	M12	50mm	8.8	6.08	50
JMHTB1255	65149	M12	55mm	8.8	6.43	50
JMHTB1260	65154	M12	60mm	8.8	6.77	50
JMHTB1270	65155	M12	70mm	8.8	7.59	50
JMHTB6101	65160	M6	10mm	10.9	1.00	100
JMHTB6121	41817	M6	12mm	10.9	1.06	100
JMHTB6161	65166	M6	16mm	10.9	1.28	100
JMHTB6201	65170	M6	20mm	10.9	1.40	100
JMHTB6251	65175	M6	25mm	10.9	1.52	100
JMHTB6301	65180	M6	30mm	10.9	1.73	100
JMHTB6351	65185	M6	35mm	10.9	1.93	100
JMHTB6401	65190	M6	40mm	10.9	2.12	100
JMHTB6451	65195	M6	45mm	10.9	2.23	100
JMHTB6501	65200	M6	50mm	10.9	2.43	100
JMHTB6601	41818	M6	60mm	10.9	3.27	100
JMHTB6701	41819	M6	70mm	10.9	3.75	100
JMHTB8101	65205	M8	10mm	10.9	2.00	100
JMHTB8121	65207	M8	12mm	10.9	2.24	100
JMHTB8161	65211	M8	16mm	10.9	2.36	100

OTHER SIZES AND QUANTITIES AVAILABLE BY REQUEST

CONTINUED ON NEXT PAGE

[www.metallics.us](http://www.metallics.us)



CONTINUED

## HEX HEAD METRIC TAP BOLTS

STEEL ZINC • 18-8 STAINLESS

Full  
Thread

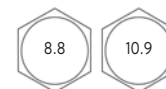

8.8

10.9

PART#	UPC#	DIAMETER	LENGTH	CLASS	WT. PER PKG.	STD. PKG. UM
<b>STEEL ZINC</b>						
JMHTB8201	65215	M8	20mm	10.9	2.98	100
JMHTB8251	65220	M8	25mm	10.9	2.99	100
JMHTB8301	65225	M8	30mm	10.9	3.32	100
JMHTB8351	65230	M8	35mm	10.9	3.75	100
JMHTB8401	65235	M8	40mm	10.9	4.07	100
JMHTB8501	63911	M8	50mm	10.9	1.22	25
JMHTB8601	41841	M8	60mm	10.9	5.21	100
JMHTB8651	63913	M8	65mm	10.9	1.45	25/125
JMHTB8701	41842	M8	70mm	10.9	6.11	100
JMHTB10201	41820	M10	20mm	10.9	4.87	100
JMHTB10251	41829	M10	25mm	10.9	4.96	100
JMHTB10301	41821	M10	30mm	10.9	3.00	50
JMHTB10351	41830	M10	35mm	10.9	6.13	100
JMHTB10401	41822	M10	40mm	10.9	3.76	50
JMHTB10501	41823	M10	50mm	10.9	4.10	50
JMHTB10601	41823	M10	60mm	10.9	4.10	50/250
JMHTB10701	41847	M10	70mm	10.9	4.10	50
JMHTB12201	65114	M12	20mm	10.9	4.89	100
JMHTB12251	41832	M12	25mm	10.9	4.91	100
JMHTB12301	41825	M12	30mm	10.9	4.30	50
JMHTB12351	41833	M12	35mm	10.9	4.37	50
JMHTB12401	41824	M12	40mm	10.9	5.15	50
JMHTB12501	41827	M12	50mm	10.9	5.97	50
JMHTB12601	41852	M12	60mm	10.9	6.77	50
JMHTB12701	41854	M12	70mm	10.9	6.84	50
JMHTB14251	41830	M14	25mm	10.9	5.05	100
JMHTB14301	41858	M14	30mm	10.9	4.41	50
JMHTB14351	41859	M14	35mm	10.9	4.53	50
JMHTB14401	41860	M14	40mm	10.9	5.19	50
JMHTB14501	41862	M14	50mm	10.9	6.06	50
JMHTB14601	41864	M14	60mm	10.9	6.83	50
JMHTB14701	41866	M14	70mm	10.9	7.06	50
<b>18-8 STAINLESS</b>						
JMHTB612SS	64917	M6	50mm	A-2	2.43	100/500
JMHTB812SS	65011	M8	12mm	A-2	2.24	100/500
JMHTB816SS	65247	M8	16mm	A-2	2.36	100/500
MHTB1650SS	60906	M16	50mm	A-2	8.73	25

OTHER SIZES AND QUANTITIES AVAILABLE BY REQUEST



8.8

10.9

## HEX HEAD METRIC BOLTS

STEEL ZINC • 18-8 STAINLESS • 316 STAINLESS

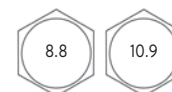

PART#	UPC#	DIAMETER	LENGTH	CLASS	WT. PER PKG.	STD. PKG. UM
<b>STEEL ZINC</b>						
JMBHC40	88240	M4	16mm	Din931	.50	100
JMBHC45	88245	M4	20mm	Din931	.59	100
JMBHC425	88625	M4	25mm	Din931	.62	100
JMBHC512	88712	M5	12mm	Din931	.57	100
JMBHC53	88253	M5	16mm	Din931	.79	100
JMBHC61	88261	M6	16mm	Din931	1.17	100
JMBHC63	88263	M6	20mm	Din931	1.37	100

OTHER SIZES AND QUANTITIES AVAILABLE BY REQUEST

CONTINUED



## HEX HEAD METRIC BOLTS

STEEL ZINC • 18-8 STAINLESS • 316 STAINLESS



PART#	UPC#	DIAMETER	LENGTH	CLASS	WT. PER PKG.	STD. PKG. UM
<b>STEEL ZINC</b>						
JMBHC620	88820	M6	20mm	Din931	1.35	100
JMBHC66	88266	M6	25mm	Din931	1.55	100
JMBHC69	88269	M6	40mm	Din931	2.12	100
JMBHC81	88281	M8	16mm	Din931	2.36	100
JMBHC80	88280	M8	20mm	Din931	2.69	100
JMBHC82	88282	M8	25mm	Din931	3.00	100
JMBHC86	88286	M8	30mm	Din931	3.33	100
JMBHC881	86091	M8	50mm	Din931	1.17	100
JMBHC1016	64116	M10	16mm	Din931	4.39	100
JMBHC1020	64120	M10	20mm	Din931	4.86	100
JMBHC1025	64125	M10	25mm	Din931	5.32	100
JMBHC1030	64130	M10	30mm	Din931	5.84	100
JMBHC1035	64135	M10	35mm	Din931	6.01	100
JMBHC1040	64140	M10	40mm	Din931	6.15	100
JMBHC10401	86095	M10	40mm	Din931	1.17	100
JMBHC1045	64145	M10	45mm	Din931	6.31	100
JMBHC1216	64216	M12	16mm	Din931	3.43	100
JMBHC1220	64220	M12	20mm	Din931	3.58	50
JMBHC1225	64225	M12	25mm	Din931	3.87	50
JMBHC1230	64230	M12	30mm	Din931	4.28	50
JMBHC1235	64235	M12	35mm	Din931	4.65	50
JMBHC1240	64240	M12	40mm	Din931	5.00	50
JMBHC1245	64245	M12	45mm	Din931	5.18	50
JMBHC1250	64250	M12	50mm	Din931	5.36	50
JMBHC1290	64290	M12	90mm	Din931	6.34	50
JMBHC1260	64260	M12	60mm	Din931	5.72	50
MBHC33160	12087	M33	160mm	Din931	44.42	20
<b>18-8 STAINLESS</b>						
JMSBHC40	21378	M4	16mm	A-2	.52	100
JMSBHC45	21379	M4	20mm	A-2	.59	100
JMSBHC425	21396	M4	25mm	A-2	.67	100
JMSBHC53	21380	M5	16mm	A-2	.79	100
JMSBHC56	21381	M5	20mm	A-2	.88	100
JMSBHC525	21397	M5	25mm	A-2	.96	100
JMSBHC612	21382	M6	12mm	A-2	1.02	100
JMSBHC616	21384	M6	16mm	A-2	1.17	100
JMSBHC620	21385	M6	20mm	A-2	1.40	100
JMSBHC625	21387	M6	25mm	A-2	1.58	100
JMSBHC69	21394	M6	40mm	A-2	2.14	100
JMSBHC834	21390	M8	20mm	A-2	2.68	100
JMSBHC825	21391	M8	25mm	A-2	2.97	100
JMSBHC830	21392	M8	30mm	A-2	3.38	100
JMSBHC88	21393	M8	40mm	A-2	4.07	100
JMSBHC812575	63999	M8	75mm	A-2	3.76	50
JMSBHC102	21361	M10	25mm	A-2	2.73	50
JMSBHC103	21362	M10	30mm	A-2	5.84	100
JMSBHC106	21364	M10	35mm	A-2	6.60	100
JMSBHC105	21363	M10	40mm	A-2	7.39	100
JMSBHC1040	21365	M10	40mm	A-2	7.27	100
JMSBHC1050	21366	M10	50mm	A-2	7.16	100
JMSBHC1220	21367	M12	20mm	A-2	3.58	50
JMSBHC1225	21372	M12	25mm	A-2	3.87	50
JMSBHC123	21368	M12	30mm	A-2	4.28	100

OTHER SIZES AND QUANTITIES AVAILABLE BY REQUEST

CONTINUED ON NEXT PAGE

CONTINUED



## HEX HEAD METRIC BOLTS

STEEL ZINC • 18-8 STAINLESS • 316 STAINLESS

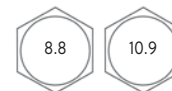

PART#	UPC#	DIAMETER	LENGTH	CLASS	WT. PER PKG.	STD. PKG. UM
<b>18-8 STAINLESS</b>						
JMSBHC1240	21369	M12	40mm	A-2	5.30	50
JMSBHC125	21370	M12	40mm	A-2	10.63	100
JMSBHC1430	79977	M14	30mm	A-2	4.41	100
JMSBHC126	21371	M16	50mm	A-2	8.73	50
<b>316 STAINLESS</b>						
JMSBHC630316	21373	M6	30mm	A-4	1.82	100
JMSBHC820316	21374	M8	20mm	A-4	2.72	100
JMSBHC1040316	21375	M10	40mm	A-4	7.22	100
JMSBHC1260316	21376	M12	60mm	A-4	13.59	100

OTHER SIZES AND QUANTITIES AVAILABLE BY REQUEST



## HEX BOLT, NUT AND WASHER KITS

18-8 STAINLESS



PART#	UPC#	ITEM	WT. PER PKG.
<b>SBHK1420 (700 pcs)</b>	94875	(50) ¼-20 x ¾ Hex Head Bolts - Stainless Steel	5.35
		(50) ¼-20 x 1 Hex Head Bolts - Stainless Steel	
		(50) ¼-20 x 1½ Hex Head Bolts - Stainless Steel	
		(200) ¼ Split Lock Washers - Stainless Steel	
		(200) ¼ Flat SAE Washers - Stainless Steel	
		(150) ¼ -20 Hex Nuts - Stainless Steel	
<b>SBHK3816 (490 pcs)</b>	94880	(40) ⅜-16 x 1 Hex Head Bolts - Stainless Steel	7.85
		(30) ⅜-16 x 1¼ Hex Head Bolts - Stainless Steel	
		(20) ⅜-16 x 1½ Hex Head Bolts - Stainless Steel	
		(150) ⅜ Split Lock Washers - Stainless Steel	
		(150) ⅜ Flat SAE Washers - Stainless Steel	
		(90) ⅜ -16 Hex Nuts - Stainless Steel	
<b>SBHK1 (20 pcs)</b>	10360	(4) 2½ Hex Head Bolts - Stainless Steel	1.01
		(4) ½-13 Hex Nut - Stainless Steel	
		(4) ½ Belleville Washers - Stainless Steel	
		(4) ½ Flat Washers - Stainless Steel	
		(4) ½ Split Lock Washers - Stainless Steel	
<b>SBHK1213 (240 pcs)</b>	94980	(20) ½ -13 x 1 Hex Head Bolts - Stainless Steel	8.75
		(15) ½ -13 x 1½ Hex Head Bolts - Stainless Steel	
		(10) ½ -13 x 2 Hex Head Bolts - Stainless Steel	
		(75) ½ Split Lock Washers - Stainless Steel	
		(75) ½ Flat SAE Washers - Stainless Steel	
		(45) ½ -13 Hex Nuts - Stainless Steel	



## HEX BOLTS

DOMESTIC • SILICON BRONZE



PART#	UPC#	DIAMETER	LENGTH	WT. PER PKG.	STD. PKG. UM
<b>DOMESTIC SILICON BRONZE</b>					
JBBH59D	84944	3/8-16	1 1/4	5.26	100
JBBH47D	79147	1/2-13	1 1/2	5.87	50
<b>SILICON BRONZE</b>					
JBBH11	80749	1/4-20	1/2	1.30	100/500
JBBH48	84948	1/4-20	5/8	1.51	100/500
JBBH1	80750	1/4-20	3/4	1.64	100/500
JBBH2	80751	1/4-20	1	1.92	100/500
JBBH19	84919	1/4-20	1 1/4	2.24	100/500
JBBH3	80752	1/4-20	1 1/2	2.48	100/500
BBH50	12650	1/4-20	1 3/4	2.51	100
JBBH4	84904	1/4-20	2	3.16	100
JBBH51	84951	1/4-20	2 1/4	3.25	100
JBBH5	84905	1/4-20	2 1/2	3.66	100
BBH52	12652	1/4-20	2 3/4	3.71	100
JBBH6	84906	1/4-20	3	4.43	100
JBBH7	84907	1/4-20	3 1/2	4.78	100
JBBH8	84908	1/4-20	4	5.34	100
JBBH91	84991	1/4-28	1	1.99	100
JBBH42	84942	5/16-18	3/4	2.60	100
JBBH54	84954	5/16-18	1 1/4	4.23	100
JBBH43	80753	5/16-18	1	3.27	100
JBBH13	84913	5/16-18	1 1/2	3.94	100
JBBH55	84955	5/16-18	1 3/4	4.01	100
JBBH14	84914	5/16-18	2	4.99	100
JBBH56	84956	5/16-18	2 1/4	5.32	100
JBBH15	84915	5/16-18	2 1/2	6.14	100
JBBH57	12642	5/16-18	2 3/4	6.20	100
JBBH16	84916	5/16-18	3	7.14	100
JBBH17	84917	5/16-18	3 1/2	8.30	100
JBBH18	84918	5/16-18	4	7.25	100
JBBH88	80754	3/8-16	1/2	3.60	100/500
JBBH44	80755	3/8-16	3/4	3.92	100/500
JBBH45	80756	3/8-16	1	4.55	100
JBBH59	84959	3/8-16	1 1/4	5.26	100
JBBH23	80757	3/8-16	1 1/2	5.96	100
JBBH60	12648	3/8-16	1 3/4	6.02	100
JBBH24	80758	3/8-16	2	7.29	100
JBBH61	84961	3/8-16	2 1/4	4.78	100
JBBH25	84925	3/8-16	2 1/2	8.73	100
JBBH62	12662	3/8-16	2 3/4	9.17	100
JBBH26	84926	3/8-16	3	6.31	50
JBBH27	84927	3/8-16	3 1/2	6.82	50
JBBH28	84928	3/8-16	4	6.81	50
JBBH29	84929	3/8-16	4 1/2	7.15	50
JBBH30	84930	3/8-16	5	4.27	25
JBBH32	84932	3/8-16	6	4.70	25
JBBH81	80759	1/2-13	3/4	8.11	100
JBBH46	80760	1/2-13	1	4.71	50
JBBH64	80761	1/2-13	1 1/4	5.31	50
JBBH47	80762	1/2-13	1 1/2	5.87	50
JBBH65	80763	1/2-13	1 3/4	6.54	50
JBBH33	80764	1/2-13	2	7.26	50

OTHER SIZES AND QUANTITIES AVAILABLE BY REQUEST

## CONTINUED HEX BOLTS

DOMESTIC • SILICON BRONZE



PART#	UPC#	DIAMETER	LENGTH	WT. PER PKG.	STD. PKG. UM
<b>SILICON BRONZE</b>					
JBBH66	12663	½-13	2¼	7.32	100
JBBH34	80765	½-13	2½	8.38	50
JBBH22	80869	½-13	2¾	8.42	50
JBBH35	80766	½-13	3	9.64	50
JBBH31	84931	½-13	3¼	10.21	50
JBBH36	84936	½-13	3½	10.87	50
JBBH40	84940	½-13	3¾	11.48	50
BBH37	12647	½-13	4	12.70	50
BBH38	12660	½-13	4½	6.68	25
JBBH39	12649	½-13	5	7.92	25
JBBH41	12657	½-13	6	9.23	25
BBH127	12624	½-13	7	4.05	10
JBBH80	85080	5/8-11	1	16.37	100
JBBH82	84320	5/8-11	1½	18.43	100
JBBH83	12608	5/8-11	1¾	18.52	100
JBBH69	84969	5/8-11	2	24.35	100
JBBH70	12667	5/8-11	2¼	24.46	100
JBBH71	84971	5/8-11	2½	25.04	100
JBBH72	12669	5/8-11	2¾	25.32	100
JBBH73	84973	5/8-11	3	28.71	100
JBBH74	12671	5/8-11	3¼	28.82	50
JBBH75	84975	5/8-11	3½	32.26	50
JBBH76	84976	5/8-11	4	15.35	50
JBBH84	84984	5/8-11	4½	39.35	50
JBBH85	84985	5/8-11	5	42.75	25
JBBH86	84986	¾-10	1½	19.48	50
JBBH77	84977	¾-10	2	19.88	50
JBBH78	84978	¾-10	2¼	19.95	50
JBBH79	84979	¾-10	2½	20.18	50
JBBH87	84987	¾-10	3	22.00	50
JBBH89	84989	¾-10	3½	24.55	50
BBH90	12622	¾-10	4	54.01	50

OTHER SIZES AND QUANTITIES AVAILABLE BY REQUEST



STEEL ZINC

18-8 STAINLESS

GALVANIZED

## HEX TAP BOLTS

STEEL ZINC • 18-8 STAINLESS  
GALVANIZED • BRASS

MADE IN USA



Full Thread  
Domestic USA

PART#	UPC#	DIAMETER	LENGTH	WT. PER PKG.	STD. PKG. UM
<b>DOMESTIC 18-8 STAINLESS</b>					
JSHTB37D	69853	½-13	¾	8.11	100
JSHTB46D	69857	½-13	1	4.71	50
JSHTB48D	69859	½-13	1¼	5.31	50
JSHTB38D	69854	½-13	1 <sup>3</sup> / <sub>8</sub>	5.62	50
JSHTB47D	69858	½-13	1½	5.84	50
JSHTB50D	69860	½-13	1¾	6.54	50
JSHTB44D	69855	3/8-16	¾	3.92	100
JSHTB45D	69856	3/8-16	1	4.55	100
JSHTB62D	69861	5/16-18	1	3.27	25
JSHTB63D	69862	5/16-18	1¾	4.71	100
JSHTB64D	69863	3/8-16	1¾	1.72	25
JSHTB65D	69864	5/8-11	2¼	13.56	50
JSHTB661D	69865	¾-10	1½	19.48	50

OTHER SIZES AND QUANTITIES AVAILABLE BY REQUEST



CONTINUED

## HEX TAP BOLTS

STEEL ZINC • 18-8 STAINLESS  
GALVANIZED • BRASS

Full  
Thread

PART#	UPC#	DIAMETER	LENGTH	WT. PER PKG.	STD. PKG. UM
<b>STEEL ZINC</b>					
JHTB91	82813	10-32	3/8	.63	100
JHTB11	80767	1/4-20	1/2	1.23	100/500
HTB11B	30156	1/4-20	1/2	25.57	2500
JHTB1	80768	1/4-20	3/4	1.48	100/500
HTB1B	30157	1/4-20	3/4	23.98	2500
JHTB2	80769	1/4-20	1	1.72	100/500
HTB2B	30162	1/4-20	1	43.04	2500
JHTB49	80770	1/4-20	1 1/4	2.07	100/500
HTB49B	30177	1/4-20	1 1/4	51.75	2500
JHTB3	80771	1/4-20	1 1/2	2.33	100/500
HTB3B	30167	1/4-20	1 1/2	53.11	2500
JHTB51	82504	1/4-20	1 3/4	2.82	100
JHTB4	80772	1/4-20	2	2.84	100
HTB42M	10474	1/4-20	2	56.80	2000
JHTB82	82804	1/4-20	2 1/2	3.39	100
JHTB6	82458	1/4-20	3	3.38	100
JHTB56	82778	1/4-20	4	4.97	100
JHTB61	82783	1/4-20	5	5.95	100
JHTB5	82739	1/4-20	6	7.03	100
JHTB38	82760	5/16-18	3/4	2.39	100
JHTB39	82761	5/16-18	1	2.84	100
JHTB54	82507	5/16-18	1 1/4	3.30	100
JHTB13	82746	5/16-18	1 1/2	3.65	100
JHTB42	82764	5/16-18	2	4.49	100
JHTB43	82765	5/16-18	2 1/2	5.82	100
JHTB55	82777	5/16-18	3	3.17	50
JHTB95	82817	5/16-18	5	4.89	50
JHTB88	80773	3/8-16	1/2	2.88	100/500
JHTB90	82812	3/8-16	5/8	3.28	100
JHTB44	80774	3/8-16	3/4	3.82	100
HTB44M	30170	3/8-16	3/4	29.98	1000
JHTB45	80775	3/8-16	1	4.12	100
HTB45M	30171	3/8-16	1	41.20	1000
JHTB59	80776	3/8-16	1 1/4	4.85	100
HTB59M	30181	3/8-16	1 1/4	53.44	1000
JHTB23	80777	3/8-16	1 1/2	5.43	100
HTB23M	30160	3/8-16	1 1/2	50.94	1000
JHTB80	82802	3/8-16	1 3/4	6.13	100
JHTB24	80778	3/8-16	2	6.75	100
JHTB25	80779	3/8-16	2 1/2	3.97	50
JHTB26	80780	3/8-16	3	4.46	50
JHTB27	82479	3/8-16	3 1/2	5.27	50
JHTB60	82513	3/8-16	4	5.76	50
JHTB93	82815	7/16-14	1	6.19	100
JHTB81	80781	1/2-13	3/4	3.78	50
JHTB46	80782	1/2-13	1	4.30	50
HTB46M	11946	1/2-13	1	85.20	1000
JHTB64	80783	1/2-13	1 1/4	4.85	50
JHTB47	80784	1/2-13	1 1/2	5.47	50
HTB47M	30174	1/2-13	1 1/2	104.90	1000
JHTB33	80785	1/2-13	2	6.62	50
HTB33M	30165	1/2-13	2	132.40	1000
JHTB34	80786	1/2-13	2 1/2	7.62	50
JHTB35	80787	1/2-13	3	8.69	50
JHTB36	76136	1/2-13	3 1/2	9.94	50

OTHER SIZES AND QUANTITIES AVAILABLE BY REQUEST

CONTINUED ON NEXT PAGE

[www.metallics.us](http://www.metallics.us)



CONTINUED

## HEX TAP BOLTS

STEEL ZINC • 18-8 STAINLESS  
GALVANIZED • BRASS

Full  
Thread



PART#	UPC#	DIAMETER	LENGTH	WT. PER PKG.	STD. PKG. UM
<b>STEEL ZINC</b>					
JHTB48	82501	½-13	4	5.56	25
JHTB62	82784	½-13	4½	6.23	25
JHTB63	82785	½-13	6	10.10	25
JHTB89	82811	5/8-11	2	5.52	25
JHTB71	82793	5/8-11	2½	6.45	25
JHTB72	82794	5/8-11	2¾	6.89	25
JHTB73	82795	5/8-11	3	7.31	25
JHTB94	82816	5/8-11	3½	8.11	25
HTB75	82799	5/8-11	4½	10.20	25
HTB83	82807	¾-10	3½	13.40	25
HTB106	82740	7/8-9	2½	17.50	25
HTB108	82742	7/8-9	4	21.25	25
<b>18-8 STAINLESS</b>					
JSHTB11	86011	¼-20	½	1.23	100
JSHTB1	86001	¼-20	¾	1.41	100
JSHTB2	86002	¼-20	1	1.85	100
JSHTB49	86049	¼-20	1¼	2.03	100
JSHTB3	86003	¼-20	1½	2.23	100
JSHTB4	86004	¼-20	2	2.81	100
JSHTB41	86041	¼-20	2½	3.31	100
JSHTB42	86042	¼-20	3	3.94	100
JSHTB61	86061	5/16-18	1¼	3.47	100
JSHTB44	86044	3/8-16	¾	3.59	100
JSHTB45	86045	3/8-16	1	4.20	100
JSHTB59	86059	3/8-16	1¼	4.86	100
JSHTB23	86023	3/8-16	1½	5.72	100
JSHTB24	86024	3/8-16	2	6.82	100
JSHTB31	86031	3/8-16	2¼	6.86	100
JSHTB25	86025	3/8-16	2½	7.94	100
JSHTB26	86026	3/8-16	3	9.24	100
SHTB60	10693	3/8-16	4	11.77	100
JSHTB30	86030	3/8-16	5	7.17	50
JSHTB451	68914	3/8-24	1	4.46	100
JSHTB46	86046	½-13	1	4.32	50
JSHTB48	86048	½-13	1¼	9.62	100
JSHTB47	86047	½-13	1½	5.67	50
JSHTB33	86033	½-13	2	6.65	50
JSHTB34	86034	½-13	2½	7.63	50
JSHTB35	86035	½-13	3	8.85	50
JSHTB36	86036	½-13	3½	5.20	25
JSHTB40	86040	½-13	6	7.82	25
JSHTB461	68939	½-20	1	4.40	50
JSHTB461	68939	½-20	1	4.40	50
JSHTB471	68941	½-20	1½	5.63	50
JSHTB661	68963	¾-10	1½	7.32	25
JSHTB662	68965	¾-10	2	8.67	25
JSHTB663	68967	¾-10	2½	9.96	25
JSHTB772	68996	1-8	2	6.99	10
JSHTB773	68998	1-8	2½	8.00	10
<b>GALVANIZED</b>					
JHTBG2	76102	¼-20	1	1.75	100/500
JHTBG3	76103	¼-20	1½	2.33	100

OTHER SIZES AND QUANTITIES AVAILABLE BY REQUEST





CONTINUED

## HEX TAP BOLTS

STEEL ZINC • 18-8 STAINLESS  
GALVANIZED • BRASS

Full  
Thread

PART#	UPC#	DIAMETER	LENGTH	WT. PER PKG.	STD. PKG. UM
<b>GALVANIZED</b>					
JHTBG45	76145	3/8-16	1	4.34	100
JHTBG59	76159	3/8-16	1¼	5.13	100
JHTBG80	76180	3/8-16	1¾	6.49	100
JHTBG46	76146	½-13	1	4.15	50
JHTBG64	76164	½-13	1¼	4.70	50
JHTBG47	76147	½-13	1½	5.26	50
JHTBG33	76133	½-13	2	6.68	50
HTBG343	76100	¾-10	3	9.22	100
JHTBG30	76130	5/8-11	1¼	17.40	100
JHTBG31	76131	5/8-11	1½	18.43	100
JHTBG69	76169	5/8-11	2	6.09	25
JHTBG70	76170	5/8-11	2½	2.11	25
<b>BRASS</b>					
JHTBRR33	84733	½-13	2	5.41	50

OTHER SIZES AND QUANTITIES AVAILABLE BY REQUEST



## CARRIAGE BOLTS

STEEL ZINC • 18-8 STAINLESS • 316 STAINLESS • GALVANIZED • METRIC

PART#	UPC#	DIAMETER	LENGTH	WT. PER PKG.	STD. PKG. UM
<b>STEEL ZINC</b>					
JCB32	83056	10-24	2	1.80	100
JCB42	83000	¼-20	½	1.34	100/500
JCB1	83001	¼-20	¾	1.66	100/500
JCB2	83002	¼-20	1	2.08	100/500
JCB3	83003	¼-20	1½	2.33	100/500
JCB4	83006	¼-20	2	2.85	100
JCB71	83043	¼-20	2½	3.42	100
CB5M	83008	¼-20	2½	34.15	1000
JCB6	83010	¼-20	3	4.09	100
JCB7	76707	¼-20	3½	4.36	100
JCB36	83070	¼-20	4½	5.48	100
JCB31	83055	¼-20	6	1.89	25
JCB43	83077	5/16-18	2¼	5.34	100
JCB21	76721	5/16-18	2½	5.64	100
JCB55	83041	3/8-16	¾	4.25	100/500
JCB56	83042	3/8-16	1	4.77	100
JCB23	83044	3/8-16	1½	6.02	100
JCB24	83046	3/8-16	2	3.61	50
JCB25	83048	3/8-16	2½	4.28	50
JCB26	83050	3/8-16	3	4.98	50
JCB27	83051	3/8-16	3½	5.54	25
JCB28	83052	3/8-16	4	6.10	50
JCB29	76729	3/8-16	5	3.70	25
JCB40	83074	3/8-16	6	8.42	50
JCB30	83054	3/8-16	8	11.05	50
JCB33	83065	½-13	2	3.07	25
JCB34	83067	½-13	2½	4.05	25
JCB35	83069	½-13	3	4.72	25
CB38	61198	½-13	4½	7.50	25

OTHER SIZES AND QUANTITIES AVAILABLE BY REQUEST

CONTINUED ON NEXT PAGE

[www.metallics.us](http://www.metallics.us)

CONTINUED

## CARRIAGE BOLTS

STEEL ZINC • 18-8 STAINLESS • 316 STAINLESS • GALVANIZED • METRIC



PART#	UPC#	DIAMETER	LENGTH	WT. PER PKG.	STD. PKG. UM
<b>STEEL ZINC</b>					
CB8	15015	½-13	6	8.28	25
JCB8	76708	½-13	6	8.28	25
CB9	14916	½-13	8	9.92	25
<b>18-8 STAINLESS</b>					
JCB42SS	91742	¼-20	½	2.09	100/500
JCB1SS	91701	¼-20	¾	1.68	100/500
JCB2SS	91702	¼-20	1	2.10	100/500
JCB3SS	91703	¼-20	1½	2.36	100
JCB7SS	91707	¼-20	2½	2.93	100
JCB41SS	91741	5/16-18	¾	2.70	100
JCB56SS	91756	5/16-18	1½	3.94	100
JCB21SS	91721	5/16-18	2½	6.09	100
JCB22SS	91722	5/16-18	3	7.11	100
JCB55SS	91755	3/8-16	¾	4.14	100/500
JCB23SS	91723	3/8-16	1½	6.01	100
JCB24SS	91724	3/8-16	2	3.64	50
JCB26SS	91726	3/8-16	3	4.95	50
JCB28SS	83078	3/8-16	4	6.26	50
JCB121SS	94721	½-13	1	4.00	50
JCB101SS	94701	½-13	1½	5.84	50
<b>METRIC 18-8 STAINLESS CLASS A2</b>					
JCBM1225SS	96125	M12	25	4.47	100/500
<b>316 STAINLESS</b>					
JCB55SS316	96260	3/8-16	¾	2.07	50
JCB56SS316	96256	3/8-16	1	2.34	50
<b>GALVANIZED</b>					
JCB24G	76924	3/8-16	2	7.12	100
JCB27G	83071	3/8-16	3½	3.16	25
JCB28G	83053	3/8-16	4	3.27	25
JCB37G	83072	3/8-16	5½	3.85	25
JCB30G	83057	3/8-16	8	5.65	25
JCB33G	76933	½-13	2	13.96	25
CB9G	15509	½-13	9	15.43	25

OTHER SIZES AND QUANTITIES AVAILABLE BY REQUEST

STEEL ZINC    18-8 STAINLESS    GALVANIZED



## HEX LAG BOLTS

STEEL ZINC • 18-8 STAINLESS • GALVANIZED

PART#	UPC#	DIAMETER	LENGTH	WT. PER PKG.	STD. PKG. UM
<b>STEEL ZINC</b>					
JBLS37	80788	¼	1	1.55	100
JBLS38	80789	¼	1¼	1.70	100
JBLS1	80790	¼	1½	1.98	100
JBLS39	80791	¼	1¾	2.29	100
JBLS2	80792	¼	2	2.62	100
JBLS3	80793	¼	2½	3.12	100
JBLS4	80794	¼	3	3.69	100
JBLS5	80795	¼	3½	4.10	100
JBLS6	82308	¼	4	4.58	100
JBLS40	76440	¼	4½	4.96	100

OTHER SIZES AND QUANTITIES AVAILABLE BY REQUEST

CONTINUED

STEEL ZINC    18-8 STAINLESS    GALVANIZED



## HEX LAG BOLTS

STEEL ZINC • 18-8 STAINLESS • GALVANIZED

PART#	UPC#	DIAMETER	LENGTH	WT. PER PKG.	STD. PKG. UM
<b>STEEL ZINC</b>					
JBLS8	76408	¼	5	5.55	100
JBLS10	76410	¼	6	6.90	100
JBLS41	76441	5/16	1	2.48	100
JBLS42	76442	5/16	1¼	2.61	100
JBLS11	80796	5/16	1½	3.03	100
JBLS43	76443	5/16	1¾	3.62	100
BLS43M	23287	5/16	1¾	36.20	1000
JBLS12	80797	5/16	2	3.72	100
JBLS13	80798	5/16	2½	4.78	100
JBLS14	80799	5/16	3	5.59	100
JBLS15	82312	5/16	3½	3.19	50
JBLS16	82324	5/16	4	3.81	50
JBLS44	76444	5/16	4½	4.01	50
JBLS18	82326	5/16	5	4.42	50
JBLS20	82327	5/16	6	5.61	50
JBLS45	80800	3/8	1	3.29	100
JBLS46	80801	3/8	1¼	3.95	100
JBLS36	80802	3/8	1½	4.50	100
JBLS47	76447	3/8	1¾	5.80	100
JBLS21	80803	3/8	2	5.63	100
JBLS22	80804	3/8	2½	3.52	50
JBLS23	80805	3/8	3	4.06	50
JBLS24	80806	3/8	3½	4.53	50
JBLS25	10408	3/8	4	4.89	50
JBLS48	76448	3/8	4½	5.64	50
*BLS48PLB	81446	3/8	4½	25.45	225
BLS48B	23288	3/8	4½	28.65	250
JBLS26	82319	3/8	5	6.50	50
JBLS49	76449	3/8	5½	6.71	50
JBLS27	82344	3/8	6	7.36	50
*BLS27PLB	81447	3/8	6	36.74	250
JBLS52	76452	3/8	7	8.89	50
*BLS59PLB	20104	3/8	8	24.54	125
BLS54	15347	3/8	10	12.75	50
JBLS53	82369	½	1½	4.19	50
JBLS28	80807	½	2	5.41	50
JBLS29	76429	½	2½	6.51	50
JBLS30	80808	½	3	7.54	50
JBLS31	76431	½	3½	8.88	50
JBLS32	82353	½	4	4.92	25
JBLS50	76450	½	4½	5.32	25
JBLS33	76433	½	5	5.99	25
JBLS51	76451	½	5½	6.57	25
JBLS34	82355	½	6	7.32	25
JBLS88	76488	¾	3	4.02	10
JBLS17	82325	¾	5	13.01	10
<b>18-8 STAINLESS</b>					
JBLS37SS	85037	¼	1	1.60	100/500
JBLS1SS	85001	¼	1½	2.11	100
JBLS2SS	85002	¼	2	2.73	100
JBLS4SS	85004	¼	3	3.94	100
BLS8SS	15361	¼	5	5.89	100
BLS10SS	15341	¼	6	3.45	50

\*PLAIN STEEL – OTHER SIZES AND QUANTITIES AVAILABLE BY REQUEST

CONTINUED ON NEXT PAGE

[www.metallics.us](http://www.metallics.us)

CONTINUED



## HEX LAG BOLTS

STEEL ZINC • 18-8 STAINLESS • GALVANIZED

PART#	UPC#	DIAMETER	LENGTH	WT. PER PKG.	STD. PKG. UM
<b>18-8 STAINLESS</b>					
JBLS11SS50	85007	5/16	1½	1.57	50
JBLS13SS	85013	5/16	1½	3.11	100
JBLS12SS50	85006	5/16	2	2.12	50
JBLS12SS	85012	5/16	2	4.24	100
JBLS14SS	85014	5/16	3	5.72	50
JBLS14SS50	85005	5/16	3	2.92	100
JBLS15SS	85015	5/16	3½	3.40	50
JBLS16SS	85016	5/16	4	3.91	50
JBLS44SS	85044	5/16	4½	5.26	50
JBLS20SS	85020	5/16	6	5.61	50
JBLS36SS	85036	3/8	1½	4.59	100
JBLS21SS	85021	3/8	2	5.94	100
JBLS583SS	85058	3/8	3	6.30	25
JBLS23SS	85023	3/8	3	4.17	50
JBLS24SS	85024	3/8	3½	9.06	100
JBLS25SS	85025	3/8	4	4.89	50
JBLS27SS	85027	3/8	6	7.97	50
JBLS30SS	85030	½	3	7.61	50
JBLS32SS	85032	½	4	4.92	25
<b>GALVANIZED</b>					
JBLS37G	28626	¼	1	1.60	100/500
JBLS1G	86401	¼	1½	2.09	100
JBLS2G	86402	¼	2	2.78	100
JBLS3G	43170	¼	2½	4.78	100
JBLS4G	28625	¼	3	3.89	100
JBLS6G	28624	¼	4	4.88	100
JBLS8G	28623	¼	5	5.95	100
JBLS10G	28622	¼	6	6.95	100
JBLS41G	86441	5/16	1	2.48	100
JBLS11G	79349	5/16	1½	2.98	100
JBLS12G	28621	5/16	2	4.01	100
BLS12GB	15482	5/16	2	34.09	850
BLS12GM	15480	5/16	2	40.10	1000
JBLS13G	28620	5/16	2½	5.07	100
JBLS14G	28619	5/16	3	5.63	100
JBLS16G	28618	5/16	4	7.22	100
JBLS18G	28617	5/16	5	9.05	100
JBLS20G	28616	5/16	6	10.73	100
JBLS45G	28615	3/8	1	3.63	100
JBLS46G	28614	3/8	1¼	4.04	100
JBLS36G	25613	3/8	1½	4.58	100
JBLS21G	86421	3/8	2	2.91	50
JBLS22G	86422	3/8	2½	3.50	50
JBLS23G	28612	3/8	3	8.12	100
JBLS24G	86424	3/8	3½	4.82	50
JBLS344G	19834	3/8	4	1.00	20
JBLS25G	86425	3/8	4	2.49	50
BLS26G	28611	3/8	5	14.01	100
JBLS27G	86427	3/8	6	7.69	50
JBLS30G	86430	½	1½	9.34	50
JBLS28G	86428	½	2	10.62	100
JBLS35G	28610	½	3	8.00	50
JBLS32G	86432	½	4	5.08	25

OTHER SIZES AND QUANTITIES AVAILABLE BY REQUEST

CONTINUED

STEEL ZINC    18-8 STAINLESS    GALVANIZED



## HEX LAG BOLTS

STEEL ZINC • 18-8 STAINLESS • GALVANIZED

PART#	UPC#	DIAMETER	LENGTH	WT. PER PKG.	STD. PKG. UM
<b>GALVANIZED</b>					
JBLS33G	28609	1/2	5	2.47	10
JBLS34G	86434	1/2	6	3.14	25
BLS90G	28608	1/2	8	4.73	10
JBLS90G	76500	1/2	8	5.78	15
JBLS58G	28607	5/8	3	6.30	25
JBLS586G	84310	5/8	6	6.05	20
BLS586G	28606	5/8	6	45.03	100
BLS588G	20120	5/8	8	30.54	50
JBLS344G	19834	3/4	4	12.56	20
JBLS346G	84312	3/4	6	18.52	10
BLS3410G	28603	3/4	10	27.90	25

OTHER SIZES AND QUANTITIES AVAILABLE BY REQUEST



## U-BOLTS

STEEL ZINC • 18-8 STAINLESS • GALVANIZED

With Hex Nuts

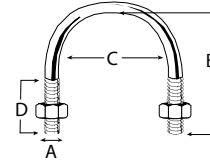

MADE IN USA



U-BOLTS ONLY!

PART#	UPC#	THREAD DIA (A)	INSIDE LENGTH (B)	INSIDE WIDTH (C)	THREAD LENGTH (D)	WT. PER PKG.	STD. PKG. UM
<b>STEEL ZINC U-BOLTS WITH NUTS</b>							
UB01	25800	1/4-20	1 1/4	9/16	3/4	.52	10
UB03	25810	1/4-20	2 1/4	3/4	1 1/2	.72	10
UB04	25815	1/4-20	1 3/4	1	1	.63	10
UB05	25820	1/4-20	2	1 1/8	1	.69	10
UB06	25825	1/4-20	2 1/4	1 1/4	1 1/4	.72	10
UB07	25830	1/4-20	2 3/4	1 1/2	1 3/8	.90	10
UB08	25835	1/4-20	3	1 3/4	1 3/8	.90	10
UB09	25840	1/4-20	3 1/4	2	1 3/8	1.07	10
UB010	25845	5/16-18	2 3/16	1	1 3/8	1.17	10
UB011	25855	5/16-18	2 3/16	1 3/8	1	1.21	10
UB012	25860	5/16-18	2 3/16	1 1/2	1	1.20	10
UB013	25865	5/16-18	2 11/16	1 3/4	1 1/8	1.40	10
UB014	25870	5/16-18	2 11/16	2	1	1.44	10
UB015	25875	5/16-18	3 3/16	2 1/2	1	1.65	10
*UB015PL	25876	5/16-18	3 3/16	2 1/2	1	1.65	10
UB016	25880	5/16-18	3 11/16	3	1	2.03	10
UB017	25885	3/8-16	2 1/4	1	1 1/4	1.77	10
UB018	25895	3/8-16	2 1/2	1 1/2	1 1/4	1.76	10
UB019	25900	3/8-16	2 3/4	1 3/4	1 1/8	2.12	10
UB021	25905	3/8-16	2 5/8	2	1 1/4	2.10	10
*UB021PL	25906	3/8-16	2 5/8	2	1 1/4	2.10	10
UB022	25910	3/8-16	3 1/8	2 1/2	1 1/4	4.33	10
UB023	25915	3/8-16	3 5/8	3	1 1/4	4.09	10
*UB023PL	25916	3/8-16	3 5/8	3	1 1/4	4.09	10
UB024	25920	3/8-16	4 1/8	3 1/2	1 1/4	3.32	10
*UB024PL	25921	3/8-16	4 1/8	3 1/2	1 1/4	3.32	10
UB025	28924	1/2-13	5	3 1/2	1 1/2	6.59	10
UB026	25926	1/2-13	6	4 1/2	1 1/2	7.76	10
*UB026PL	25923	1/2-13	6	4 1/4	1 1/2	7.76	10
UB045	25945	1/2-13	8 3/8	6 3/4	2	9.53	10
<b>18-8 STAINLESS U-BOLTS WITH NUTS</b>							
UBS01	26100	1/4-20	1 1/4	9/16	3/4	.52	10
UBS03	26110	1/4-20	2 1/4	3/4	1 1/2	.74	10
UBS04	26115	1/4-20	1 3/4	1	1	.58	10

\*WITH PLATE AND NUTS - OTHER SIZES AND QUANTITIES AVAILABLE BY REQUEST

CONTINUED ON NEXT PAGE



CONTINUED

## U-BOLTS

STEEL ZINC • 18-8 STAINLESS • GALVANIZED

With Hex Nuts

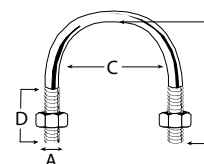

MADE IN USA



U-BOLTS ONLY!

PART#	UPC#	THREAD DIA (A)	INSIDE LENGTH (B)	INSIDE WIDTH (C)	THREAD LENGTH (D)	WT. PER PKG.	STD. PKG. UM
<b>18-8 STAINLESS U-BOLTS WITH NUTS</b>							
UBS05	26120	1/4-20	2	1 1/8	1	1.01	10
UBS06	26125	1/4-20	2 1/4	1 1/4	1 1/4	.69	10
UBS07	26130	1/4-20	2 3/4	1 1/2	1 3/8	.81	10
UBS08	26135	1/4-20	3	1 3/4	1 3/8	.92	10
UBS09	26140	1/4-20	3 1/4	2	1 3/8	.97	10
UBS010	26145	5/16-18	2 3/16	1	1 3/8	1.17	10
UBS011	26150	5/16-18	2 3/16	1 3/8	1	1.18	10
UBS516138	10307	5/16-18	2 3/16	1 3/8	1	5.90	50
UBS012	26155	5/16-18	2 3/16	1 1/2	1	1.23	10
UBS013	26160	5/16-18	2 11/16	1 3/4	1 1/8	1.40	10
UBS516134	10308	5/16-18	2 11/16	1 3/4	1 3/8	7.00	50
UBS014	26165	5/16-18	2 11/16	2	1	1.43	10
UBS015	26170	5/16-18	3 3/16	2 1/2	1	1.72	10
UBS016	26175	5/16-18	3 11/16	3	1	2.03	10
UBS017	26180	3/8-16	2 1/4	1	1 1/4	1.77	10
UBS018	26190	3/8-16	2 1/2	1 1/2	1 1/4	1.78	10
UBS020	26195	3/8-16	2 3/4	1 3/4	1 1/8	2.09	10
UBS021	26200	3/8-16	2 5/8	2	1 1/4	2.17	10
UBS022	26205	3/8-16	3 1/8	2 1/2	1 1/4	2.70	10
UBS023	26210	3/8-16	3 5/8	3	1 1/4	2.91	10
UBS38212	10306	3/8-16	3 5/8	3	1 1/4	14.55	50
UBS024	26215	3/8-16	4 1/8	3 1/2	1 1/4	3.12	10
UBS025	26216	1/2-13	6	4 1/2	1 1/2	7.20	10
<b>GALVANIZED U-BOLTS WITH NUTS</b>							
UBG010	76810	5/16-18	2 3/16	1	1 3/8	2.06	10
UBG014	76814	5/16-18	2 11/16	2	1	2.10	10
UBG015	76815	5/16-18	3 3/16	2 1/2	1	2.41	10
UBG018	60399	3/8-16	2 1/2	1 1/2	1 1/4	2.08	10
UBG021	76821	3/8-16	2 5/8	2	1 1/4	2.04	10
UBG022	76822	3/8-16	3 1/8	2 1/2	1 1/4	2.36	10
UBG023	76823	3/8-16	3 5/8	3	1 1/4	2.75	10

OTHER SIZES AND QUANTITIES AVAILABLE BY REQUEST





# QUADRIVE CONCRETE SCREW ANCHORS

**"STOP THE SNAPPING"**  
It's a Screw and an Anchor

Large fillet under head to fit 3/16" and 1/4" holes provides greater driving strength

Fluted, interrupted threads aid tapping into masonry products

Hilo threads for faster application

Silver color to match conduit, strap and concrete

We will be glad to send a sample bag of 10 pieces to our Distributors for their customer trials. Please specify size!

Also available in Flat Head.

A coating is applied after heat-treating to provide anti-corrosion protection. The coating is a RoHs compliant mechanical zinc coating that offers 2000 hours to 15% red rust corrosion in salt spray testing performed to ASTM B117 specifications.

Metallics offers our Distributor/Contractor users an alternative to the blue color of standard concrete screws. Silver color is cosmetically appealing when used with zinc plated or stainless steel brackets, electrical fixtures or conduit.







## QUADRIVE CONCRETE SCREW ANCHOR KITS

STEEL MECHANICAL ZINC /CORROSION RESISTANT

PART#	UPC#	SIZE/ITEM	QTY.	WT. PER PKG.	STD. PKG. UM
<b>QCSHK1</b> (112 pcs) 3/16" Kit	39200	3/16 x 1 1/4 – 4 Drives	50	1.33	1/25
		3/16 x 1 3/4 – 4 Drives	35		
		3/16 x 2 1/4 – 4 Drives	25		
		5/32 x 3 1/2 Masonry Drill	1		
		1/4 Drill Chuck	1		
<b>QCSHK2</b> (112 pcs) 1/4" Kit	39204	1/4 x 1 1/4 – 4 Drives	50	2.11	1/25
		1/4 x 1 3/4 – 4 Drives	35		
		1/4 x 2 1/4 – 4 Drives	25		
		3/16 x 3 1/2 Masonry Drill	1		
		5/16 Drill Chuck	1		

OTHER SIZES AND QUANTITIES AVAILABLE BY REQUEST



The Gold Standard of Concrete Screws

## QUADRIVE CONCRETE SCREW ANCHOR

STEEL MECHANICAL ZINC/CORROSION RESISTANT

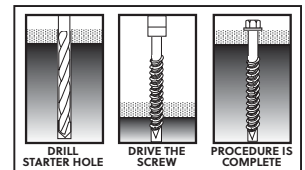

**FOUR DRIVES IN ONE HEAD**  
Hex, Slotted, Phillips & Square Drives  
One Masonry Drill Packaged with Every Jar.

Cuts threads in structural concrete, hollow block, brick and mortar. A unique double lead and cutting thread speeds installation.

PART#	UPC#	DIAMETER	LENGTH	DRILL STOCK NO.	WT. PER PKG.	STD. PKG. UM
<b>1/4" HEAD</b>						
QCSH1	39145	3/16	1 1/4	CD1	.79	100/500
QCSH2	39146	3/16	1 3/4	CD1	1.12	100/500
QCSH3	39147	3/16	2 1/4	CD2	1.39	100
<b>5/16" HEAD</b>						
QCSH10	39148	1/4	1 1/4	CD5	1.43	100/500
QCSH20	39149	1/4	1 3/4	CD5	1.86	100/500
QCSH30	39150	1/4	2 1/4	CD6	2.29	100
QCSH40	39151	1/4	2 3/4	CD6	2.77	100

ONE MASONRY DRILL AND INSERT BIT PACKAGED WITH EVERY JAR.

## 1000 BULK PACK IN CARTON – CONCRETE SCREWS ONLY

PART#	UPC#	DIAMETER	LENGTH	WT. PER PKG.	STD. PKG. UM
QCSH1B	39152	3/16	1 1/4	8.30	1000
QCSH2B	39153	3/16	1 3/4	15.10	1000
QCSH3B	39154	3/16	2 1/4	18.00	1000
QCSH10B	39155	1/4	1 1/4	10.35	1000
QCSH20B	39156	1/4	1 3/4	17.80	1000
QCSH30B	39157	1/4	2 1/4	22.47	1000
QCSH40B	39158	1/4	2 3/4	34.50	1000

MASONRY DRILLS NOT INCLUDED IN 1000 PACK.

OTHER SIZES AND QUANTITIES AVAILABLE BY REQUEST



## FLAT HEAD SQUARE DRIVE CONCRETE ANCHOR SCREW

STEEL MECHANICAL ZINC /CORROSION RESISTANT



PART#	UPC#	DIAMETER	LENGTH	WT. PER PKG.	STD. PKG. UM
FSCS1	39651	3/16	1¼	.65	100/500
FSCS2	39652	3/16	1¾	.85	100/500
FSCS3	39653	3/16	2¼	2.25	100
FSCS10	39660	¼	1¼	1.30	100/500
FSCS20	39665	¼	1¾	1.70	100
FSCS30	39670	¼	2¼	2.35	100
FSCS40	39675	¼	2¾	2.80	100



## QUADRIVE CONCRETE SCREW ANCHOR DISPLAY

### CDQCSH10 Contains:

- 27 jars of the most common size Concrete Screw ¼ x 1¼" QuaDrive.
- 100 pieces per jar.
- Free counter display and free shipping.



- Large fillet under head.
- Fluted interrupted threads.
- Hilo threads.
- Silver color to match conduit, strap and concrete

## QUADRIVE SOCKET DRIVER

### QUADRIVE SOCKET DRIVERS - FOR QUADRIVE CONCRETE SCREWS



PART#	UPC#	HEAD SIZE	LENGTH	WT. PER PKG.	STD. PKG. UM
1591910	39091	¼	2 <sup>5</sup> / <sub>8</sub>	.26	1
1513910	39092	5/16	2 <sup>5</sup> / <sub>8</sub>	.53	1

OTHER SIZES AND QUANTITIES AVAILABLE BY REQUEST. SAFETY GLASSES SHOULD BE WORN FOR ANY DRIVING APPLICATIONS.



## MASONRY DRILL BITS FOR CONCRETE SCREWS

Can be used with our  
QuaDrive and Blue  
Concrete Screws

PART#	UPC#	DIAMETER	LENGTH	SCREW DIA.	WT. PER PKG.	STD. PKG. UM
CD1	31250	5/32	3½	3/16	.02	1
CD2	31255	5/32	4½	3/16	.02	1
CD3	31260	5/32	5½	3/16	.02	1
CD5	31265	3/16	3½	¼	.02	1
CD6	31270	3/16	4½	¼	.02	1
CD7	31275	3/16	5½	¼	.03	1
CD8	31280	3/16	6½	¼	.05	1

OTHER SIZES AND QUANTITIES AVAILABLE BY REQUEST



## HEX INDENTED SLOTTED WASHER HEAD BLUE CONCRETE SCREW ANCHOR KITS STEEL MECHANICAL ZINC /CORROSION RESISTANT

PART#	UPC#	SIZE/ITEM	WT. PER PKG.	QTY.	STD. PKG. UM
CSH316RF (112 pcs)	87370	$\frac{3}{16} \times 1\frac{1}{4}$	1.29	50	1/25
		$\frac{3}{16} \times 1\frac{3}{4}$		35	
		$\frac{3}{16} \times 2\frac{1}{4}$		25	
		$3\frac{1}{2} \times \frac{5}{32}$ masonry drill		1	
		MT208 $\frac{1}{4}$ chuck		1	
CSH14RF (112 pcs)	87365	$\frac{1}{4} \times 1\frac{1}{4}$	2.00	50	1/25
		$\frac{1}{4} \times 1\frac{3}{4}$		35	
		$\frac{1}{4} \times 2\frac{1}{4}$		25	
		$3\frac{1}{2} \times \frac{3}{16}$ masonry drill		1	
		MT210 $\frac{5}{16}$ chuck		1	

OTHER SIZES AND QUANTITIES AVAILABLE BY REQUEST



### BLUE CONCRETE SCREW ANCHOR

*It's A Tapping Screw Anchoring System*

DOMESTIC STAINLESS STEEL • STEEL MECHANICAL  
ZINC /CORROSION RESISTANT

*One Masonry Drill Packaged with Every Jar.*



**INDENTED HEX SLOTTED WASHER HEAD**

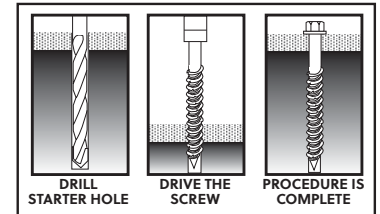

*Cuts threads in structural concrete, hollow block, brick and mortar. A unique double lead and cutting thread speeds installation.*

PART#	UPC#	DIAMETER	LENGTH	DRILL STOCK NO.	WT. PER PKG.	STD. PKG. UM
<b><math>\frac{1}{4}</math>" HEX DRIVER</b>						
CSH1F	87101	$\frac{3}{16}$	$1\frac{1}{4}$	CD1	.80	100/500
CSH2F	87102	$\frac{3}{16}$	$1\frac{3}{4}$	CD1	1.03	100/500
CSH3F	87103	$\frac{3}{16}$	$2\frac{1}{4}$	CD2	1.32	100
CSH4F	87104	$\frac{3}{16}$	$2\frac{3}{4}$	CD2	1.62	100
CSH5F	87105	$\frac{3}{16}$	$3\frac{1}{4}$	CD3	1.88	100
CSH6F	87106	$\frac{3}{16}$	4	CD3	2.35	100
<b>DOMESTIC <math>\frac{5}{16}</math>" HEX DRIVER</b>						
CSH10D	87111	$\frac{1}{4}$	$1\frac{1}{4}$	CD5	1.28	100
<b><math>\frac{5}{16}</math>" HEX DRIVER</b>						
CSH10F	87110	$\frac{1}{4}$	$1\frac{1}{4}$	CD5	1.28	100/500
CSH10FM	77510	$\frac{1}{4}$	$1\frac{1}{4}$	CD5	12.15	1000
CSH20F25	87122	$\frac{1}{4}$	$1\frac{3}{4}$	CD5	.45	25
CSH20F	87120	$\frac{1}{4}$	$1\frac{3}{4}$	CD5	1.71	100
CSH20FM	87121	$\frac{1}{4}$	$1\frac{3}{4}$	CD5	16.23	1000
CSH30F	87130	$\frac{1}{4}$	$2\frac{1}{4}$	CD6	2.14	100
CSH30FM	87131	$\frac{1}{4}$	$2\frac{1}{4}$	CD6	20.23	1000
CSH40F	87140	$\frac{1}{4}$	$2\frac{3}{4}$	CD6	2.57	100
CSH50F	87150	$\frac{1}{4}$	$3\frac{1}{4}$	CD7	3.11	100
CSH50FM	87303	$\frac{1}{4}$	$3\frac{1}{4}$	CD7	31.15	1000
CSH60F	87160	$\frac{1}{4}$	4	CD7	3.62	100
CSH70F	87170	$\frac{1}{4}$	5	CD7	4.46	100
CSH80F	87180	$\frac{1}{4}$	6	CD8	6.48	100
<b>410 STAINLESS - <math>\frac{5}{16}</math>" HEX DRIVER</b>						
CSH1SS	90259	$\frac{3}{16}$	$1\frac{1}{4}$	CD1	.79	100/500
CSH10SS	90260	$\frac{1}{4}$	$1\frac{1}{4}$	CD5	1.38	100/500
CSH20SS	90270	$\frac{1}{4}$	$1\frac{3}{4}$	CD5	1.67	100
CSH30SS	87100	$\frac{1}{4}$	$1\frac{3}{4}$	CD5	1.02	100
CSH80SS	90265	$\frac{1}{4}$	6	CD8	6.48	100

OTHER SIZES AND QUANTITIES AVAILABLE BY REQUEST



## FLAT HEAD PHILLIPS BLUE CONCRETE SCREW ANCHOR

STEEL MECHANICAL ZINC /CORROSION RESISTANT • STAINLESS STEEL

One Masonry Drill Packaged With Every Jar.



PART#	UPC#	DIAMETER	LENGTH	DRILL STOCK NO.	WT. PER PKG.	STD. PKG. UM
<b>#2 PHILLIPS BIT</b>						
CSF1F	87201	3/16	1¼	CD1	.78	100/500
CSF2F	87202	3/16	1¾	CD1	1.05	100/500
CSF3F	87203	3/16	2¼	CD2	1.35	100
CSF4F	87204	3/16	2¾	CD2	1.52	100
CSF5F	87205	3/16	3¼	CD3	1.80	100
CSF6F	87206	3/16	4	CD3	2.02	100
<b>#3 PHILLIPS BIT</b>						
CSF10F	87210	¼	1¼	CD5	1.25	100/500
CSF20F	87220	¼	1¾	CD5	1.75	100/500
CSF30F	87230	¼	2¼	CD6	2.11	100
CSF40F	87240	¼	2¾	CD6	2.15	100
CSF50F	87250	¼	3¼	CD7	2.88	100
CSF60F	87260	¼	4	CD7	3.70	100
CSF70F	87270	¼	5	CD7	4.50	100
<b>410 STAINLESS – #2 PHILLIPS BIT</b>						
CSF2SS	96602	3/16	1¾	CD1	1.05	100/500
CSF4SS	96604	3/16	2¾	CD2	1.50	100

OTHER SIZES AND QUANTITIES AVAILABLE BY REQUEST



## CONCRETE SCREW INSTALLATION KIT

8 PIECE KIT

### KIT INCLUDES:

- 1 - Drill Driver
- 1 - Phillips Bit Holder
- 1 - Drill Adapter
- 2 - Phillips Bits
- 2 - Hex Drivers
- 1 - Allen Hex Key

PART#	UPC#	SIZE	ITEM	WT. PER PKG.	STD. PKG. UM
IT1000	31200	-	Installation Tool (complete kit)	.95	1
<b>REPLACEMENT COMPONENTS FOR KIT – SOLD SEPARATELY –</b>					
MHD14	31205	¼	Magnetic Hex Driver	.04	1
MHD56	31210	5/16	Magnetic Hex Driver	.05	1
PBH	31215	#2 & #3	Phillips Bit Holder	.01	1
ITSLEVE	31203	-	Drill/Driver Adapter	.28	1
PB2	31220	#2	Phillips Bit	.01	1
PB3	31225	#3	Phillips Bit	.01	1
HK1	31230	1/8	Allen Hex Key	.01	1

OTHER SIZES AND QUANTITIES AVAILABLE BY REQUEST

DOES NOT INCLUDE DRILL BIT

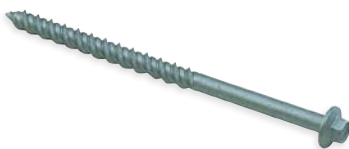

## HEX HEAD CONCRETE SCREW ANCHOR

CARBON STEEL TAPPER® SILVER COATING

PART#	UPC#	DIAMETER	LENGTH	WT. PER PKG.	STD. PKG. UM
<b>CARBON STEEL</b>					
M2202SD	11512	5/16	2¼	3.66	100
M2220SD	11514	5/16	5	2.32	100

OTHER SIZES AND QUANTITIES AVAILABLE BY REQUEST



## HEX LARGE DIAMETER CONCRETE SCREW ANCHORS

STEEL ZINC • 410 STAINLESS • 304 STAINLESS



PART#	UPC#	ANCHOR DIAMETER	SOCKET SIZE	DRILL BIT DIAMETER	MIN. DEPTH	LENGTH	WT. PER PKG.	STD. PKG. UM
<b>STEEL ZINC</b>								
LCS14178	14462	¼	¾	¼	1¾	17/8	3.60	100
LCS14234	14463	¼	¾	¼	1¾	2¾	4.60	100
LCS14300	14465	¼	¾	¼	1¾	3	2.80	50
LCS14350	14466	¼	¾	¼	1¾	3½	3.20	50
LCS1440	14467	¼	¾	¼	1¾	4	3.60	50
LCS3816	14470	¾	9/16	¾	2½	1¾	4.14	50
LCS3824	14471	¾	9/16	¾	2½	2½	4.20	50
LCS3830	14472	¾	9/16	¾	2½	3	4.83	50
LCS3840	14473	¾	9/16	¾	2½	4	7.83	50
LCS3850	14474	¾	9/16	¾	2½	5	9.34	40
LCS3860	14475	¾	9/16	¾	2½	6	7.11	30
LCS1230	14480	½	¾	½	3¼	3	5.95	25
LCS1240	14481	½	¾	½	3¼	4	7.50	25
LCS1250	14482	½	¾	½	3¼	5	8.91	25
LCS1260	14483	½	¾	½	3¼	6	8.29	20
LCS1265	14484	½	¾	½	3¼	6½	9.44	20
LCS1280	14485	½	¾	½	3¼	8	5.68	10
LCS1212	14469	½	¾	½	3¼	12	4.16	5
LCS1213	14477	½	¾	½	3¼	13	4.49	5
LCS1214	14478	½	¾	½	3¼	14	4.82	5
LCS1215	14479	½	¾	½	3¼	15	5.15	5
LCS5840	14812	5/8	15/16	5/8	4	4	5.20	10
LCS5850	14813	5/8	15/16	5/8	4	5	6.19	10
LCS5860	14814	5/8	15/16	5/8	4	6	7.11	10
LCS5865	14815	5/8	15/16	5/8	4	6½	7.71	10
LCS5880	14816	5/8	15/16	5/8	4	8	9.14	10
LCS5810	14817	5/8	15/16	5/8	4	10	4.85	5
LCS3440	14823	¾	1 1/8	¾	5½	4	3.91	5
LCS3450	14824	¾	1 1/8	¾	5½	5	4.60	5
LCS346	14476	¾	1 1/8	¾	5½	6	12.0	10
LCS3470	14825	¾	1 1/8	¾	5½	7	5.98	5
LCS3485	14826	¾	1 1/8	¾	5½	8½	6.95	5
LCS3410	14827	¾	1 1/8	¾	5½	10	7.25	5
<b>410 STAINLESS</b>								
LCS3816SS	14468	¾	9/16	¾	2½	1¾	3.70	50
LCS1240SS	92936	½	¾	½	3¼	4	5.98	25
<b>304 STAINLESS</b>								
LCS3816SS	14468	¾	9/16	¾	2½	1¾	3.70	50
LCS3830SS	15511	¾	9/16	¾	2½	3	6.50	50
LCS3840SS	15512	¾	9/16	¾	2½	4	8.50	50
LCS3850SS	15513	¾	9/16	¾	2½	5	10.00	50
LCS3860SS	15514	¾	9/16	¾	2½	6	12.00	50
LCS1230SS	14495	½	¾	½	3¼	3	5.05	25
LCS1240SS	92936	½	¾	½	3¼	4	5.98	25
LCS1250SS	15515	½	¾	½	3¼	5	9.50	25
LCS1260SS	15516	½	¾	½	3¼	6	8.80	20
LCS1265SS	15517	½	¾	½	3¼	6½	9.40	20
LCS1280SS	15518	½	¾	½	3¼	8	5.70	10
LCS5840SS	15524	5/8	15/16	5/8	4	4	5.20	10
LCS5850SS	15525	5/8	15/16	5/8	4	5	6.20	10

CONTINUED



Hex

## HEX LARGE DIAMETER CONCRETE SCREW ANCHORS

STEEL ZINC • 410 STAINLESS • 304 STAINLESS

PART#	UPC#	ANCHOR DIAMETER	SOCKET SIZE	DRILL BIT DIAMETER	MIN. DEPTH	LENGTH	WT. PER PKG.	STD. PKG. UM
<b>304 STAINLESS</b>								
LCS5860SS	15526	5/8	15/16	5/8	4	6	7.10	10
LCS5865SS	15527	5/8	15/16	5/8	4	6½	7.70	10
LCS5880SS	15528	5/8	15/16	5/8	4	8	9.10	10
LCS3440SS	15519	¾	1⅛	¾	3½	4	7.80	10
LCS3450SS	15520	¾	1⅛	¾	3½	5	9.20	10
LCS3460SS	15521	¾	1⅛	¾	3½	6	12.00	10
LCS3470SS	15522	¾	1⅛	¾	3½	7	12.00	10
LCS3485SS	15523	¾	1⅛	¾	3½	8½	13.90	10

## HEX LARGE DIAMETER CONCRETE SCREW ANCHORS

STEEL MECHANICALLY GALVANIZED

*High strength screw anchor for concrete and masonry.*

*Designed for optimum performance in both cracked concrete and uncracked concrete under both static and seismic conditions.*

*City of Los Angeles #RR25741 #RR25560 (CMU) Florida FL11506.7 Factory Mutual 3017082*



Hex

PART#	UPC#	ANCHOR DIAMETER	SOCKET SIZE	DRILL BIT DIAMETER	MIN. DEPTH	LENGTH	WT. PER PKG.	STD. PKG. UM
LCSX3830	14490	3/8	9/16	3/8	2½	3	6.05	50
LCSX3850	14492	3/8	9/16	3/8	2½	3½	7.61	40
LCSX3860	14493	3/8	9/16	3/8	2½	6	9.48	40
LCSX1230	14496	½	¾	½	3¼	3	5.97	25
LCSX1240	14497	½	¾	½	3¼	4	6.38	25
LCSX1250	14498	½	¾	½	3¼	5	9.00	25
LCSX1260	14499	½	¾	½	3¼	6	11.03	25
LCSX1265	14501	½	¾	½	3¼	6½	11.80	25
LCSX1280	14504	½	¾	½	3¼	8	11.36	20
LCSX5850	14506	5/8	15/16	5/8	4	5	6.19	10
LCSX5860	14507	5/8	15/16	5/8	4	6	7.11	10
LCSX5865	14508	5/8	15/16	5/8	4	6½	7.71	10
LCSX5880	14509	5/8	15/16	5/8	4	8	9.14	10
LCSX3460	14512	¾	1⅛	¾	5½	6	10.56	10
LCSX3485	14513	¾	1⅛	¾	5½	8½	12.80	10
LCSX3410	14514	¾	1⅛	¾	5½	10	14.50	10



We believe Metallics has the largest ratio of American made to foreign produced product of any other American fastener company.





## ULTIMATE ANCHOR KITS

Choose The Right Kit That's Right For You! The Right Anchors  
For Any Job. Same Price Regardless Of The Kit You Choose.

**1 Kit For  
Any Job!**

PART#	UPC#	QTY.	SIZE	ITEM	WT. PER PKG.	STD. PKG. UM
<b>UAK1 (362 pcs)</b> 	33241	40	¼	Plastic Red Anchors	3.23	1
		40	#10 x 1	Pan Head Tapping Screws CD		
		1	¼ x 4	Masonry Drill Bit		
		30	#6-8	Plastic Self-Drilling Wall Anchors		
		30	#8 x 1¼	Pan Head Tapping Screws CD		
		30	#8	Zinc Alloy Self-Drilling Wall Anchors		
		30	#8 x 1¼	Pan Head Tapping Screws CD		
		40	¼	Plastic Blue Anchors		
		40	#10 x 1	Pan Head Tapping Screws		
		40	¼ x 1¼	Blue Concrete Screw Anchors - Hex		
		1	5/32 x 3½	Drill Bit		
		20	3/16	Spring Wing Toggle		
		20	10-24 x 3	Mushroom Head Screws		
		<b>UAK2 (362 pcs)</b> 	33242	40		
40	#10 x 1			Pan Head Tapping Screws CD		
1	¼ x 4			Masonry Drill Bit		
30	#6-8			Plastic Self-Drilling Wall Anchors		
30	#8 x 1¼			Pan Head Tapping Screws CD		
30	#8			Zinc Alloy Self-Drilling Wall Anchors		
30	#8 x 1¼			Pan Head Tapping Screws CD		
40	¼			Plastic Yellow Anchors		
40	#10 x 1			Pan Head Tapping Screws		
40	¼ x 1¼			Blue Concrete Screw Anchors - Hex		
1	5/32 x 3½			Drill Bit		
20	3/16			Spring Wing Toggle Heads		
20	10-24 x 3			Mushroom Head Screws CD		
<b>UAK3 (362 pcs)</b> 	33243			40	¼	Plastic Red Anchors
		40	#10 x 1	Pan Head Tapping Screws CD		
		1	¼ x 4	Masonry Drill Bit		
		30	#6-8	Plastic Self-Drilling Wall Anchors		
		30	#8 x 1¼	Pan Head Tapping Screws CD		
		30	#8	Zinc Alloy Self-Drilling Wall Anchors		
		30	#8 x 1¼	Pan Head Tapping Screws CD		
		40	¼	Plastic Yellow Anchors		
		40	#10 x 1	Pan Head Tapping Screws CD		
		40	¼ x 1¼	Quadrine Concrete Silver Screw Anchors		
		1	5/32 x 3½	Drill Bit		
		20	3/16	Spring Wing Toggle		
		20	10-24 x 3	Mushroom Head Screws		
		<b>UAK4 (352 pcs)</b> 	33244	40	¼	Plastic Red Anchors
40	#10 x 1			Pan Head Tapping Screws CD		
1	¼ x 4			Masonry Drill Bit		
30	#6-8			Plastic Self-Drilling Wall Anchors		
30	#8 x 1¼			Pan Head Tapping Screws CD		
30	#8			Zinc Alloy Self-Drilling Wall Anchors		
30	#8 x 1¼			Pan Head Tapping Screws CD		
40	¼			Plastic Yellow Anchors		
40	#10 x 1			Panhead Tapping Screws CD		
40	¼ x 1¼			Blue Concrete Screw Anchors - Hex		
1	5/32 x 3½			Drill Bit		
30	¼ x 1			Metal Hammer Drive Nail in Anchors		

OTHER SIZES, MATERIALS AND QUANTITIES AVAILABLE BY REQUEST



## WALL DOG™ ANCHORS

Universal Light Duty Anchors

All steel, one-piece screw anchors, features high-profile threads for easy fastening into wallboard and other masonry base materials

- Installs in a variety of base materials
- Installs directly through fixtures into wallboard – no second step is required
- When removed the Wall Dog leaves a much smaller hole than toggles or other systems
- Thread design prevents spinning and stripping
- Heat treated point penetrates metal and wood studs
- Two finished heads, oval and pan
- Two colors, chrome & white head
- No pilot hole required for wallboard
- Can be easily backed out of hole
- No hole spotting required



Four Heads in One!



## COMBO HEX WASHER HEAD LIGHT DUTY WALL DOG™ ANCHORS

STEEL ZINC

PART#	UPC#	ANCHOR LENGTH	DRILL BIT SIZE	WT. PER PKG.	STD. PKG. UM
MWDH114J	28014	1¼	3/16	.91	100/500
MWDH114K	28015	1¼	3/16	.91	100
MWDH1141M	28016	1¼	3/16	9.10	1000



## WAFER PHILLIPS HEAD LIGHT DUTY WALL DOG™ ANCHORS

STEEL ZINC

PART#	UPC#	ANCHOR LENGTH	DRILL BIT SIZE	WT. PER PKG.	STD. PKG. UM
MWDWW112J	28017	1½	3/16	.89	100/500
MWDWW112K	28018	1½	3/16	.89	100/500
MWDWW1121M	28019	1½	3/16	8.90	1000
MWDWW2J	28020	2	3/16	1.15	100/500
MWDWW2K	28021	2	3/16	1.15	100/500
MWDWW21M	28022	2	3/16	11.50	1000
MWDWW214J	28023	2¼	3/16	1.25	100/500
MWDWW214K	28024	2¼	3/16	1.25	100/500
MWDWW2141M	28025	2¼	3/16	12.50	1000
MWDWW212J	28026	2½	3/16	1.35	100/500
MWDWW212K	28027	2½	3/16	1.35	100/500
MWDWW2121M	28028	2½	3/16	13.50	1000



## SQUARE HEAD LIGHT DUTY ROBERTSON WALL DOG™ ANCHORS

STEEL ZINC

PART#	UPC#	ANCHOR LENGTH	DRILL BIT SIZE	WT. PER PKG.	STD. PKG. UM
MWDS114J	28030	1¼	3/16	.89	100/500
MWDS114K	28029	1¼	3/16	.89	100/500
MWDS1141M	28031	1¼	3/16	8.90	1000



## OVAL/PHILLIPS HEAD LIGHT DUTY WALL DOG™ ANCHORS

STEEL ZINC

PART#	UPC#	ANCHOR LENGTH	COLOR	DRILL BIT SIZE	WT. PER PKG.	STD. PKG. UM
MWDOZ114J	28032	1¼	Zinc	3/16	.80	100/500
MWDOZ114K	28033	1¼	Zinc	3/16	.80	100/500
MWDOZ1141M	28034	1¼	Zinc	3/16	8.00	1000
MWDOW114J	28035	1¼	White	3/16	.90	100/500
MWDOW114K	28036	1¼	White	3/16	.90	100/500
MWDOW1141M	28037	1¼	White	3/16	9.00	1000
MWDOBLK114J	28038	1¼	Black	3/16	.80	100/500
MWDOBLK114K	28039	1¼	Black	3/16	.80	100/500
MWDOBLK1141M	28040	1¼	Black	3/16	8.00	1000
MWDOBR114J	28041	1¼	Brass	3/16	.82	100/500
MWDOBR114K	28042	1¼	Brass	3/16	.82	100/500
MWDOBR1141M	28043	1¼	Brass	3/16	8.20	1000



## PAN/PHILLIPS HEAD LIGHT DUTY WALL DOG™ ANCHORS

STEEL ZINC

PART#	UPC#	ANCHOR LENGTH	COLOR/TYPE	DRILL BIT SIZE	WT. PER PKG.	STD. PKG. UM
MWDPZ114J	28044	1¼	Zinc	3/16	.79	100/500
MWDPZ114K	28045	1¼	Zinc	3/16	.79	100/500
MWDPZ1141M	28046	1¼	Zinc	3/16	7.90	1000
MWDPW114J	28047	1¼	White	3/16	.79	100/500
MWDPW114K	28048	1¼	White	3/16	.79	100/500
MWDPW1141M	28049	1¼	White	3/16	7.90	1000
MWDPBLK114J	28059	1¼	Black	3/16	.79	100/500
MWDPBLK114K	28060	1¼	Black	3/16	.79	100/500
MWDPBLK1141M	28061	1¼	Black	3/16	7.90	1000
MWDPBR114J	28063	1¼	Brass	3/16	.91	100/500
MWDPBR114K	28062	1¼	Brass	3/16	.91	100/500
MWDPBR1141M	28064	1¼	Brass	3/16	9.10	1000
MWDPW112J	28050	1½	White	3/16	.89	100/500
MWDPW112K	28051	1½	White	3/16	.89	100/500
MWDPW1121M	28052	1½	White	3/16	8.90	1000
MWDPBZ112J	28053	1½	Bronze	3/16	.91	100/500
MWDPBZ112K	28054	1½	Bronze	3/16	.91	100/500
MWDPBZ1121M	28055	1½	Bronze	3/16	9.10	1000
MWDPBLKP112J	28056	1½	Black	3/16	.89	100/500
MWDPBLKP112K	28057	1½	Black	3/16	.89	100/500
MWDPBLKP1121M	28058	1½	Black	3/16	8.90	1000

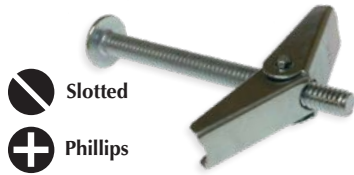

Slotted  
 Phillips

## SPRING WING TOGGLE BOLTS

STEEL ZINC • 18-8 STAINLESS  
 Bolts And Wings In One Package  
 Round • Flat • Truss

PART#	JAR UPC#	DIAMETER	LENGTH	DRILL SIZE	WT. PER PKG.	STD. PKG. UM
<b>STEEL ZINC</b>						
<b>ROUND HEAD</b>						
J1501 (Slot/Phil)	80809	1/8 6/32	2	1/8 WING/7/16 DRILL	.72	50
J1502 (Slot/Phil)	80810	1/8 6/32	3		.80	50
J1503 (Slot/Phil)	81203	1/8 6/32	4		1.09	50
J1504 (Slot)	81204	1/8 6/32	6		2.60	50
J1505 (Slot/Phil)	80811	3/16 10-24	2	3/16 WING/9/16 DRILL	1.40	50
J1506 (Slot/Phil)	80812	3/16 10-24	3		1.71	50
1506M (Slot/Phil)	74806	3/16 10-24	3		33.20	1000
15065M (Slot/Phil)	75208	3/16 10-24	3		166.04	5000
J1507 (Slot/Phil)	81207	3/16 10-24	4		1.95	50
1507B (Slot/Phil)	62100	3/16 10-24	4		39.39	1000
J1508 (Slot)	81208	3/16 10-24	5		2.35	50
J1509 (Slot)	81209	3/16 10-24	6		2.60	50
J1511 (Slot/Phil)	80813	1/4 1/4-20	3	1/4 WING/3/4 DRILL	2.93	50
J1511XXV (Slot/Phil)	28740	1/4 1/4-20	3		1.48	25
J1512 (Slot/Phil)	10396	1/4 1/4-20	4		3.53	50
1512CB (Slot/Phil)	21847	1/4 1/4-20	4		17.25	250
1512V (Slot/Phil)	60712	1/4 1/4-20	4		36.60	500
1512B (Slot/Phil)	62104	1/4 1/4-20	4		73.22	1000
J1513 (Slot)	81213	1/4 1/4-20	5		3.93	50
J1514 (Slot)	81214	1/4 1/4-20	6		4.47	50
J1597 (Slot/Phil)	81249	1/4 1/4-20	6		4.29	50
J1515 (Slot)	10406	5/16 5/16-18	3		5/16 WING/7/8 DRILL	2.62
J1516 (Slot)	10407	5/16 5/16-18	4	3.05		25
J1517 (Slot)	81217	5/16 5/16-18	5	3.55		25
J1518 (Slot)	81218	5/16 5/16-18	6	4.03		25
J1519 (Slot/Phil)	81219	3/8 3/8-16	3	3/8 WING/1" DRILL	3.72	25
J1520 (Slot/Phil)	81220	3/8 3/8-16	4		4.28	25
J1521 (Slot)	81221	3/8 3/8-16	5		5.06	25
J1522 (Slot/Phil)	81222	3/8 3/8-16	6		5.60	25
J1523 (Slot)	81223	1/2 1/2-13	4	c	3.95	10
J1524 (Slot)	81224	1/2 1/2-13	5		4.25	10
J1525 (Slot)	81225	1/2 1/2-13	6		4.85	10
<b>18-8 STAINLESS</b>						
<b>ROUND HEAD</b>						
J1507SS (Slot)	96907	3/16 10-24	4	3/16 WING/9/16 DRILL	2.11	50
J1511SS (Slot)	96911	1/4 1/4-20	3	1/4 WING/3/4 DRILL	2.91	50
J1512SS (Slot)	96912	1/4 1/4-20	4	1/4 WING/3/4 DRILL	3.37	50
J1520SS (Slot)	96920	3/8 3/8-16	4	3/8 WING/1" DRILL	4.36	25
<b>STEEL ZINC</b>						
<b>FLAT HEAD</b>						
J1528 (Slot)	81228	1/8 6/32	2	1/8 WING/7/16 DRILL	.69	50
J1529 (Slot)	80814	1/8 6/32	3		.87	50
J1530 (Slot)	81230	1/8 6/32	4		.97	50
J1531 (Slot)	81231	3/16 10-24	2	3/16 WING/9/16 DRILL	1.48	50
J1532 (Slot)	81232	3/16 10-24	3		1.68	50
J1533 (Slot)	81233	3/16 10-24	4		2.10	50
J1534 (Slot)	81234	3/16 10-24	5		2.24	50
J1535 (Slot)	81235	3/16 10-24	6		2.62	50
J1536 (Slot)	81236	1/4 1/4-20	3		2.82	50
J1537 (Slot)	81237	1/4 1/4-20	4	1/4 WING/3/4 DRILL	3.31	50
J1538 (Slot)	81238	1/4 1/4-20	5		3.96	50
J1539 (Slot)	81239	1/4 1/4-20	6		4.46	50
J1528 (Slot)	81228	1/8 6/32	2	1/8 WING/7/16 DRILL	.69	50
J1529 (Slot)	80814	1/8 6/32	3		.87	50
J1530 (Slot)	81230	1/8 6/32	4		.97	50

OTHER SIZES AND QUANTITIES AVAILABLE BY REQUEST

CONTINUED ON NEXT PAGE

[www.metallics.us](http://www.metallics.us)

CONTINUED

## SPRING WING TOGGLE BOLTS

STEEL ZINC • 18-8 STAINLESS  
Bolts And Wings In One Package  
Round • Flat • Truss



Slotted

Phillips

PART#	JAR UPC#	DIAMETER	LENGTH	DRILL SIZE	WT. PER PKG.	STD. PKG. UM	
<b>STEEL ZINC</b>							
<b>FLAT HEAD</b>							
J1531 (Slot)	81231	<sup>3</sup> / <sub>16</sub> 10-24	2	<sup>3</sup> / <sub>16</sub> WING/ <sup>9</sup> / <sub>16</sub> DRILL	1.48	50	
J1532 (Slot)	81232	<sup>3</sup> / <sub>16</sub> 10-24	3		1.68	50	
J1533 (Slot)	81233	<sup>3</sup> / <sub>16</sub> 10-24	4		2.10	50	
J1534 (Slot)	81234	<sup>3</sup> / <sub>16</sub> 10-24	5		2.24	50	
J1535 (Slot)	81235	<sup>3</sup> / <sub>16</sub> 10-24	6		2.62	50	
J1536 (Slot)	81236	<sup>1</sup> / <sub>4</sub> <sup>1</sup> / <sub>4</sub> -20	3		<sup>1</sup> / <sub>4</sub> WING/ <sup>3</sup> / <sub>4</sub> DRILL	2.82	50
J1537 (Slot)	81237	<sup>1</sup> / <sub>4</sub> <sup>1</sup> / <sub>4</sub> -20	4	3.31		50	
J1538 (Slot)	81238	<sup>1</sup> / <sub>4</sub> <sup>1</sup> / <sub>4</sub> -20	5	3.96		50	
J1539 (Slot)	81239	<sup>1</sup> / <sub>4</sub> <sup>1</sup> / <sub>4</sub> -20	6	4.46		50	
J1540 (Slot)	81240	<sup>5</sup> / <sub>16</sub> <sup>5</sup> / <sub>16</sub> -18	3	<sup>5</sup> / <sub>16</sub> WING/ <sup>7</sup> / <sub>8</sub> DRILL	2.55	25	
J1541 (Slot)	81241	<sup>5</sup> / <sub>16</sub> <sup>5</sup> / <sub>16</sub> -18	4		2.88	25	
J1542 (Slot)	81242	<sup>5</sup> / <sub>16</sub> <sup>5</sup> / <sub>16</sub> -18	5		3.22	25	
J1543 (Slot)	81243	<sup>5</sup> / <sub>16</sub> <sup>5</sup> / <sub>16</sub> -18	6		3.79	25	
J1544 (Slot)	81244	<sup>3</sup> / <sub>8</sub> <sup>3</sup> / <sub>8</sub> -16	3		<sup>3</sup> / <sub>8</sub> WING/1" DRILL	3.49	25
J1545 (Slot)	81245	<sup>3</sup> / <sub>8</sub> <sup>3</sup> / <sub>8</sub> -16	4	4.22		25	
J1546 (Slot)	81246	<sup>3</sup> / <sub>8</sub> <sup>3</sup> / <sub>8</sub> -16	5	4.90		25	
J1547 (Slot)	81247	<sup>3</sup> / <sub>8</sub> <sup>3</sup> / <sub>8</sub> -16	6	5.75		25	
<b>TRUSS HEAD</b>							
J1548 (Slot)	80815	<sup>1</sup> / <sub>8</sub> <sup>6</sup> / <sub>32</sub>	2	<sup>1</sup> / <sub>8</sub> WING/ <sup>7</sup> / <sub>16</sub> DRILL	.75	50	
J1549 (Slot/Phil)	80816	<sup>1</sup> / <sub>8</sub> <sup>6</sup> / <sub>32</sub>	3		.82	50	
J1550 (Slot/Phil)	80817	<sup>1</sup> / <sub>8</sub> <sup>6</sup> / <sub>32</sub>	4		1.01	50	
J1551 (Slot/Phil)	80818	<sup>3</sup> / <sub>16</sub> 10-24	3	<sup>3</sup> / <sub>16</sub> WING/ <sup>9</sup> / <sub>16</sub> DRILL	1.70	50	
J1551XXV (Slot/Phil)	20190	<sup>3</sup> / <sub>16</sub> 10-24	3		.90	25	
J1552 (Slot/Phil)	10397	<sup>3</sup> / <sub>16</sub> 10-24	4	<sup>1</sup> / <sub>4</sub> WING/ <sup>3</sup> / <sub>4</sub> DRILL	2.04	50	
J1553 (Slot/Phil)	10399	<sup>1</sup> / <sub>4</sub> <sup>1</sup> / <sub>4</sub> -20	3		3.05	50	
J1554 (Slot/Phil)	10398	<sup>1</sup> / <sub>4</sub> <sup>1</sup> / <sub>4</sub> -20	4		3.50	50	
<b>TRUSS HEAD</b>							
J1560 (Square)	80819	<sup>1</sup> / <sub>8</sub> <sup>6</sup> / <sub>32</sub>	2	<sup>1</sup> / <sub>8</sub> WING/ <sup>7</sup> / <sub>16</sub> DRILL	.84	50	
J1561 (Square)	80820	<sup>1</sup> / <sub>8</sub> <sup>6</sup> / <sub>32</sub>	3		.95	50	
J1562 (Square)	80821	<sup>1</sup> / <sub>8</sub> <sup>6</sup> / <sub>32</sub>	4		1.10	50	
J1563 (Square)	80822	<sup>3</sup> / <sub>16</sub> 10-24	2	<sup>3</sup> / <sub>16</sub> WING/ <sup>9</sup> / <sub>16</sub> DRILL	1.58	50	
J1564 (Square)	80823	<sup>3</sup> / <sub>16</sub> 10-24	3		1.85	50	
J1565 (Square)	81265	<sup>3</sup> / <sub>16</sub> 10-24	4		2.08	50	
J1566 (Square)	81266	<sup>1</sup> / <sub>4</sub> <sup>1</sup> / <sub>4</sub> -20	3		<sup>3</sup> / <sub>16</sub> / <sup>9</sup> / <sub>16</sub> DRILL	3.03	50
J1567 (Square)	81267	<sup>1</sup> / <sub>4</sub> <sup>1</sup> / <sub>4</sub> -20	4			3.55	50

OTHER SIZES AND QUANTITIES AVAILABLE BY REQUEST



## SPRING WING TOGGLE HEADS

STEEL ZINC • 18-8 STAINLESS

PART#	JAR UPC#	THREAD DIAMETER	DRILL SIZE	WT. PER PKG.	STD. PKG. UM
<b>STEEL ZINC</b>					
J1590	80824	6-32	<sup>7</sup> / <sub>16</sub>	.71	100/500
J1591	80864	8-32	<sup>7</sup> / <sub>16</sub>	1.04	100
J1592	80825	10-24	<sup>9</sup> / <sub>16</sub>	1.38	100
J1593	80826	<sup>1</sup> / <sub>4</sub> -20	<sup>3</sup> / <sub>4</sub>	2.25	100
J1594	80827	<sup>5</sup> / <sub>16</sub> -18	<sup>7</sup> / <sub>8</sub>	4.20	100
J1595	80828	<sup>3</sup> / <sub>8</sub> -16	1	1.47	25
J1596	80829	<sup>1</sup> / <sub>2</sub> -13	1 <sup>1</sup> / <sub>4</sub>	4.42	25
<b>18-8 STAINLESS</b>					
J1592SS	96992	10-24	<sup>9</sup> / <sub>16</sub>	.74	50
J1593SS	96993	<sup>1</sup> / <sub>4</sub> -20	<sup>3</sup> / <sub>4</sub>	.94	50
J1595SS	13294	<sup>3</sup> / <sub>8</sub> -16	1	1.54	25

OTHER SIZES AND QUANTITIES AVAILABLE BY REQUEST

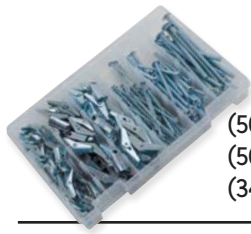

## MUSHROOM HEAD TOGGLE BOLT KIT STEEL ZINC

- (50) 5/32" x 3" Mushroom Head Combo Drive Screw
- (50) 5/32" Spring Wing Toggle
- (34) 10-24" x 3" Mushroom Head Combo Drive Screw
- (34) 10-24" Spring Wing Toggle
- (20) 1/4-20" x 4" Mushroom Head Combo Drive Screw
- (20) 1/4-20" Spring Wing Toggle

PART#	UPC#	WT. PER PKG.	STD. PKG. UM
TBMK1 (208 pcs)	70060	3.73	1

OTHER SIZES AND QUANTITIES AVAILABLE BY REQUEST



## COBRA TRIPLEGRIP™ MULTI-PURPOSE ANCHORS & KITS

MAXIMUM LOAD CAPACITY

Requires: Drill  
and #2 Phillips

- Slotted
- Phillips

ANCHOR	DRILL BIT	DRYWALL 5/8"		CONCRETE 3000 psi	
		PULL	SHEAR	PULL	SHEAR
6	1/4	60 lbs.	91 lbs.	240 lbs.	400 lbs.
8	1/4	64 lbs.	102 lbs.	275 lbs.	500 lbs.
10	5/16	88 lbs.	154 lbs.	400 lbs.	800 lbs.
12	3/8	132 lbs.	204 lbs.	500 lbs.	900 lbs.

PART#	UPC#	DIAMETER	LENGTH	ITEM	WT. PER PKG.	STD. PKG. UM
TGA6	72655	6	-	Triple Grip Anchors	.14	100
TGA8	72657	8	-	Triple Grip Anchors	.11	100
TGA10	72659	10	-	Triple Grip Anchors	.20	100
TGA12	72661	12	-	Triple Grip Anchors	.30	100
TGA6K	72665	6	1 1/4	Pan Head Sheet Metal Screws	.65	100
		1/4	4	(1) Masonry Drill		
TGA8K	72667	8	-	Triple Grip Anchors	.81	100
		8	1 1/4	Pan Head Sheet Metal Screws		
		1/4	4	(1) Masonry Drill		
TGA10K	72669	10	-	Triple Grip Anchors	1.33	100
		10	1 1/2	Pan Head Sheet Metal Screws		
		5/16	4	(1) 5/16 x 4" Masonry Drill		
TGA12K	72671	12	-	Triple Grip Anchors	1.20	50
		12	1 1/2	Pan Head Sheet Metal Screws		
		3/8	4	(1) Masonry Drill		
TGA6J	72675	6	-	Triple Grip Anchors	.66	100
		6	1 1/4	Pan Head Sheet Metal Screws		
		1/4	4	(1) 1/4 x 4" Masonry Drill		
TGA8J	72677	8	-	Triple Grip Anchors	.83	100
		8	1 1/4	Pan Head Sheet Metal Screws		
		1/4	4	(1) Masonry Drill		
TGA10J	72679	10	-	Triple Grip Anchors	1.31	100
		10	1 1/2	Pan Head Sheet Metal Screws		
		5/16	4	(1) 5/16 x 4" Masonry Drill		
TGA12J	72681	12	-	Triple Grip Anchors	1.01	50
		12	1 1/2	Pan Head Sheet Metal Screws		
		3/8	4	(1) Masonry Drill		

OTHER SIZES AND QUANTITIES AVAILABLE BY REQUEST

Note: Part numbers with a "K" are packaged in plastic boxes. Part numbers with a "J" are packaged in plastic jars.



## SUPER WALL PLATE SCREW KIT

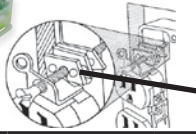

- 50 Wall plate screws in white, ivory, and almond.
- 100 Screws to secure electrical device to electrical box.
- 50 Quick Fix GB spacers to shim electrical device so wall plate is flush to wall.

PART#	UPC#	DIAMETER	LENGTH	SCREW TYPE/ITEM	WT. PER PKG.	STD. PKG. UM
SWPK1 (300 pcs)	20360	6-32	½	Slotted Oval Head White Painted Screw	.98	50
		6-32	½	Slotted Oval Head Ivory Painted Screw		50
		6-32	½	Slotted Oval Head Almond Painted Screw		50
		6-32	¾	Slotted Flat Head Machine Screw		50
		6-32	1	Slotted Flat Head Machine Screw		50
		-	-	Quick Fix GB Stackable Spacers		50

OTHER SIZES AND QUANTITIES AVAILABLE BY REQUEST



## PLASTIC TOGGLES

Stays in place if screw is removed. Ideal product for sheetrock.

PART#	UPC#	SIZE & WALL DIA.	DRILL PER PKG.	SCREW PKG.	WT. PER PKG.	STD. PKG. UM
JCPT1	80970	¾	5/16	#8	.55	100
JCPT2	80971	½	5/16	#8	.57	100
JCPT3	80972	5/8	5/16	#8	.59	100

ORDER SCREWS SEPARATELY – #8 DIAMETER – SEE SECTION – SCREWS

OTHER SIZES AND QUANTITIES AVAILABLE BY REQUEST



## HOLLOW BLOCK T-ANCHORS

STEEL ZINC

PART#	UPC#	DIAMETER	LENGTH	THREAD LENGTH	DRILL SIZE	WT. PER PKG.	STD. PKG. UM
JTA14134	80830	¼	1¾	1	5/16	.93	25
JTA14212	80831	¼	2½	1¾	5/16	.90	25
JTA14314	80832	¼	3¼	2 <sup>5</sup> / <sub>8</sub>	5/16	1.31	25
JTA516212	80833	5/16	2½	1 <sup>5</sup> / <sub>8</sub>	5/16	1.60	25
JTA516314	80834	5/16	3¼	2 <sup>3</sup> / <sub>8</sub>	5/16	2.03	25
JTA516334	80835	5/16	3¾	2 <sup>7</sup> / <sub>8</sub>	5/16	2.31	25
JTA38314	80836	3/8	3¼	2¼	3/8	2.88	25
JTA38334	81143	3/8	3¾	2¾	3/8	3.05	25
JTA38412	81146	3/8	4½	3½	3/8	3.59	25

OTHER SIZES AND QUANTITIES AVAILABLE BY REQUEST



Includes Combo Head Machine Screw

## HOLLOW WALL SCREW ANCHORS

STEEL ZINC



Slotted



Phillips

PART#	UPC#	SIZE & WALL THICKNESS	GRIP RANGE	DRILL SIZE	WT. PER PKG.	STD. PKG. UM
J1001	80839	1/8 X-Short	1/16-¼	5/16	.91	100
J1002	80840	1/8 Short	1/8-½	5/16	1.36	100
J1003	80841	1/8 Long	5/8-7/8	5/16	1.81	100
J1004	80842	3/16 Short	1/8-5/8	7/16	3.45	100
J1005	80843	3/16 Long	5/8-1 <sup>3</sup> / <sub>16</sub>	7/16	2.15	50
1008	18635	3/16 X-Long	1¼-1¾	7/16	4.85	100
J1006	80844	¼ Short	1/8-5/8	½	2.81	50
J1007	80845	¼ Long	5/8-1 <sup>3</sup> / <sub>16</sub>	½	3.65	50

OTHER SIZES AND QUANTITIES AVAILABLE BY REQUEST



Phillips

## HOLLOW WALL SCREW ANCHORS DRIVE POINT STEEL ZINC

Includes Combo  
Head Machine Screw

PART#	UPC#	SIZE & WALL THICKNESS	GRIP RANGE	DRILL SIZE	WT. PER PKG.	STD. PKG. UM
J6721	80837	1/8 Short	1/8 - 1/2	5/16	1.37	100/500
J6726	80838	1/8 Long	1/8 - 13/16	5/16	1.84	100

OTHER SIZES AND QUANTITIES AVAILABLE BY REQUEST

## RAPID-SET® TOOLS



The fastest, easiest and most reliable way to install machine screw lead (caulk-in) anchors

- For machine screw lead (caulk-in) anchor sizes 1/4" and 3/8".
- Automatically sets anchor just below the surface.
- Designed for use with power tools.
- Maximizes expansion of bottom portion of lead sleeve.

PART#	UPC#	SIZE	WT. PER PKG.	STD. PKG. UM
MRST1420	25110	1/4-20	.14	1
MRST3816	25112	3/8-16	.26	1

\*Note: Rapid-Set Tools draw the anchor's internal insert up into the anchor's outer sleeve; this installation process eliminates the need to maintain a back bearing surface (required by hammer setting tools).



## MACHINE SCREW LEAD ANCHORS

One Setting Tool Included in Each Jar of Anchors

PART#	UPC#	SIZE	HOLE SIZE	ANCHOR LENGTH	WT. PER PKG.	STD. PKG. UM
J1401	83155	6-32	5/16	17/32	.81	100
J1402	80846	8-32	5/16	17/32	.91	100
J1403	80847	10-24	3/8	11/16	1.78	100
J1405	80849	12-24	1/2	5/8	3.82	100
J1406	80850	1/4-20	1/2	7/8	3.80	100
1406M	11122	1/4-20	1/2	7/8	36.07	1000
J1407	80851	5/16-18	5/8	1 1/16	6.69	100
1407M	11123	5/16-18	5/8	1 1/16	65.00	1000
J1408	80852	3/8-16	3/4	1 5/16	5.14	50
1408M	11124	3/8-16	3/4	1 5/16	103.13	1000
J1409	80853	1/2-13	7/8	1 9/16	8.97	50
1409V	11127	1/2-13	7/8	1 9/16	44.50	500
1409M	11125	1/2-13	7/8	1 9/16	89.00	1000
1410	17845	5/8-11	1 1/8	2	20.12	50
1411	17847	3/4-10	1-1 1/4	1 3/4	12.82	25

OTHER SIZES AND QUANTITIES AVAILABLE BY REQUEST

Not recommended for cement ceiling applications. Please note that machine screw anchors have a lead outer gripping shell. In applications where lead is considered dangerous, we do not recommend their use.



## MACHINE SCREW LEAD ANCHOR SETTING TOOLS

STEEL ZINC



PART#	UPC#	SIZE	WT. PER PKG.	STD. PKG. UM
1401ST	17900	6-32	.04	1
1402ST	17905	8-32	.07	1
1403ST	17910	10-24	.08	1
1405ST	17920	12-24	.16	1
1406ST	17925	¼-20	.17	1
1407ST	17930	5/16-18	.27	1
1408ST	17935	3/8-16	.38	1
1409ST	17940	½-13	.58	1

OTHER SIZES AND QUANTITIES AVAILABLE BY REQUEST

## MULTI-PURPOSE ANCHORS

STEEL ZINC



TD4112

PD4112/PD8134

FD8234

**Tie Wire Anchors** - For acoustical ceilings and suspended electrical fixtures.

**Pipe Hanging Anchors** - For sprinkler, water lines, steam/gas and electrical conduits. Available in ¼-20 and 3/8-16 internal thread.

**Forming Anchors** - For wood attachments to concrete.

PART#	UPC#	SIZE	ANCHOR TYPE	DRILL BIT SIZE	INT. THREAD	MIN. EMBEDMENT	FIXTURE HOLE SIZE	HOLE SIZE I.D.	WT. PER PKG.	STD. PKG. UM
TD4112	73918	-	Tie Wire	¼	-	1 1/8	-	9/32	3.21	100
PD4112	73924	¼-20	Pipe Hanging	3/16	¼-20	1 ¼	-	-	2.56	100
PD8134	73925	3/8-16	Pipe Hanging	¼	3/8-16	1 ½	-	-	5.84	100
FD8234	73915	2 ¾	Duplex	¼	-	1 ¼	5/16	-	3.64	100

OTHER SIZES AND QUANTITIES AVAILABLE BY REQUEST



Anchor

Tool

## SNAKE+™ INTERNAL THREAD SELF-TAPPING ANCHORS

STEEL ZINC

No Hammer Required!

PART#	UPC#	THREAD SIZE	SIZE MIN. HOLE DEPTH	DRILL SIZE INTERNAL THREAD DEPTH	WT. PER PKG.	STD. PKG. UM
M6400SD	24197	¼-20	2	22/32	2.43	100
M6401SD	24187	3/8-16	1 5/8	11/16	2.70	50
M6403SD	24188	½-13	2 ½	29/32	8.20	50
M6407SD	24192		3/8 Setting Tool		.41	1
M6404SD	24189		½ Setting Tool		.42	1



## LAG SCREW SHIELDS

ALLOY ZINC DIE CAST  
Medium-Duty Application

PART#	UPC#	LAG SCREW DIAMETER	HOLE SIZE	ANCHOR LENGTH	WT. PER PKG.	STD. PKG. UM
<b>SHORT</b>						
J1201	80854	¼	½	1	1.06	50
J1202	80855	5/16	½	1¼	1.21	50
J1203	80856	3/8	5/8	1¾	2.19	50
J1204	80857	½	¾	2	1.46	25
J1205	80858	5/8	7/8	2	2.74	25
J1206	83081	¾	1	2	3.98	25
<b>LONG</b>						
J1207	80859	¼	½	1½	1.48	50
J1208	80860	5/16	½	1¾	1.45	50
J1209	80861	3/8	5/8	2	3.38	50
J1210	80862	½	¾	3	2.98	25
J1211	80863	5/8	7/8	3½	5.37	25
J1212	83086	¾	1	3½	6.13	25

OTHER SIZES AND QUANTITIES AVAILABLE BY REQUEST

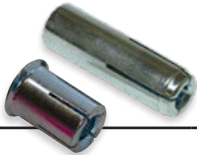

## DROP-IN ANCHORS

DOMESTIC • STEEL ZINC • 18-8 STAINLESS • 316 STAINLESS • MINI



PART#	UPC#	SIZE	HOLE SIZE	ANCHOR LENGTH	WT. PER PKG.	STD. PKG. UM
<b>DOMESTIC STEEL ZINC W/TOOL</b>						
JDIA14D	77173	¼-20	3/8	1	3.01	100
JDIA38D	77177	3/8-16	½	1 <sup>9</sup> / <sub>16</sub>	3.54	50
JDIA12D	50064	½-13	5/8	2	6.41	50
<b>STEEL ZINC W/NO TOOL</b>						
JDIA14L (Lipped)	28742	¼-20	3/8	1	2.35	100
JDIA14	81870	¼-20	3/8	1	2.29	100
DIA14CB	21860	¼-20	3/8	1	5.83	250
DIA14M	17869	¼-20	3/8	1	22.91	1000
JDIA38	81875	3/8-16	½	1 <sup>9</sup> / <sub>16</sub>	3.26	50
DIA38CB	21862	3/8-16	½	1 <sup>9</sup> / <sub>16</sub>	16.30	250
DIA38M	17879	3/8-16	½	1 <sup>9</sup> / <sub>16</sub>	58.00	1000
JDIA38L (Lipped)	28743	3/8-16	½	1 <sup>9</sup> / <sub>16</sub>	3.18	50
JDIA12	81880	½-13	5/8	2	6.41	50
DIA12M	17884	½-13	5/8	2	115.80	1000
JDIA12L (Lipped)	28741	½-13	5/8	2	6.05	50
JDIA58	81881	5/8-11	7/8	2½	8.91	25
DIA58C	17887	5/8-11	7/8	2½	35.60	100
JDIA34	81873	¾-10	1	3 <sup>3</sup> / <sub>16</sub>	13.58	25
DIA34B	17889	¾-10	1	3 <sup>3</sup> / <sub>16</sub>	27.16	50
<b>MINI STEEL WITH LIP W/TOOL</b>						
JDIA14MINI	77185	¼-20	3/8	5/8	1.71	100
JDIA38MINI	81877	3/8-16	½	¾	3.33	100
JDIA12MINI	77184	½-13	5/8	1	6.67	100
<b>MINI STEEL W/NO TOOL</b>						
M6335	24196	¼-20	3/8	5/8	6.26	100
M6322	24191	3/8-16	½	¾	3.03	50
<b>18-8 STAINLESS W/TOOL</b>						
JDIA14SS	81872	¼-20	3/8	1	2.54	100
JDIA38SS	81876	3/8-16	½	1 <sup>9</sup> / <sub>16</sub>	3.50	50
JDIA12SS	81883	½-13	5/8	2	6.25	50
JDIA58SS	81882	5/8-11	7/8	2½	8.36	25
<b>316 STAINLESS W/TOOL</b>						
JDIA141SS	90345	¼-20	3/8	1	2.64	100
JDIA381SS	90349	3/8-16	½	1 <sup>9</sup> / <sub>16</sub>	6.45	100
JDIA121SS	90353	½-13	5/8	2	6.03	50
JDIA581SS	61179	5/8-11	5/8	2½	8.15	25

OTHER SIZES AND QUANTITIES AVAILABLE BY REQUEST

## DROP-IN ANCHOR SETTING TOOLS

STEEL ZINC

For Setting Drop-In Anchors



PART#	UPC#	SIZE	WT. PER PKG.	STD. PKG. UM
DIA14T	12181	¼-20	.18	1
DIA38T	12182	¾-16	.24	1
DIA12T	12183	½-13	.41	1
DIA58T	12184	⅝-11	.51	1
DIA34T	17890	¾-10	1.03	1

OTHER SIZES AND QUANTITIES AVAILABLE BY REQUEST

## SMART DROP-IN & DI+ SETTING TOOLS

STEEL ZINC • 304 STAINLESS • CARBON



Tool

PART#	UPC#	SIZE	WT. PER PKG.	STD. PKG. UM
<b>TOOL</b>				
M425SD	11056	¼	.41	1
M427SD	11057	¾	.50	1
<b>304 STAINLESS STEEL W/NO TOOL</b>				
M6206	24186	¾	3.13	50
<b>SMART DI AND CARBON</b>				
M6304SD	24182	¼	2.39	100
M6306SD	24184	¾	3.31	50
M6308SD	23610	½	11.31	100

OTHER SIZES AND QUANTITIES AVAILABLE BY REQUEST

## SINGLE EXPANSION ANCHORS

ZINC ALLOY



PART#	UPC#	THREAD DIAMETER	HOLE SIZE	ANCHOR BODY LENGTH	WT. PER PKG.	STD. PKG. UM
JSEA14	81195	¼	½	1	2.57	100
JSEA16	81196	⅝	⅝	1¼	2.44	50
JSEA38	81197	¾	¾	1½	2.32	50
JSEA12	81198	½	⅞	2	3.04	25
JSEA58	81200	⅝	1	2⅝	5.06	25

OTHER SIZES AND QUANTITIES AVAILABLE BY REQUEST

## HOLLOW SET DROP-IN ANCHOR

ZAMAC ALLOY CARBON STEEL  
STAINLESS STEEL CONES

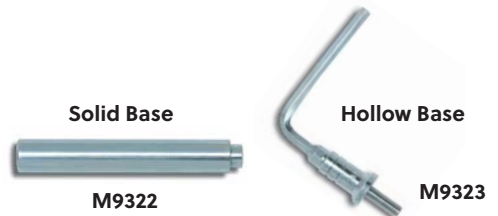

Solid Base

Hollow Base

M9322

M9323

PART#	UPC#	SIZE	WT. PER PKG.	STD. PKG. UM
<b>STEEL ZINC NO/TOOL</b>				
M9320	71659	¼	1.30	100
<b>TOOL FOR SOLID BASE MATERIAL</b>				
M9322	11072	¼	.99	1
<b>TOOL FOR HOLLOW BASE MATERIAL</b>				
M9323	11073	¼	.99	1

OTHER SIZES AND QUANTITIES AVAILABLE BY REQUEST



## DOUBLE EXPANSION ANCHORS

ZINC ALLOY

PART#	UPC#	THREAD DIAMETER	HOLE SIZE	ANCHOR BODY LENGTH	WT. PER PKG.	STD. PKG. UM
JDEA14	80872	1/4	1/2	1	2.94	100
JDEA516	80873	5/16	5/8	1 1/4	2.82	50
JDEA38	80874	3/8	3/4	1 1/2	4.48	50
DEA38M	90491	3/8	3/4	1 1/2	84.00	1000
JDEA12	80875	1/2	7/8	2	3.70	25
JDEA58	82397	5/8	1	2 1/4	5.15	25
DEA34	17802	3/4	1 1/4	2 7/8	9.97	20

OTHER SIZES AND QUANTITIES AVAILABLE BY REQUEST

## ROD COUPLING SLEEVE ANCHORS

Anchors Threaded Rod To Concrete Ceilings



PART#	UPC#	BOLT AND HOLE DIA.	BOLT LENGTH	WT. PER PKG.	STD. PKG. UM
5810	17135	1/4	1 1/2	8.81	100
RCA381	32762	3/8	1 7/8	9.24	100
JRCA38150	81584	3/8	1 7/8	4.62	50
RCA12214	32760	1/2	2 1/4	9.93	50
JRCA12SLV25	81583	1/2	2 1/4	4.97	25
RCA12	32758	1/2	2 3/4	10.56	50

OTHER SIZES AND QUANTITIES AVAILABLE BY REQUEST

## WOOD AND TAPPING SCREW LEAD ANCHORS



PART#	UPC#	SIZE	LENGTH	HOLE SIZE	WT. PER PKG.	STD. PKG. UM
J1301	80876	6-8	3/4	1/4	1.12	100/500
J1302	80877	6-8	1	1/4	1.47	100/500
J1303	80878	6-8	1 1/2	1/4	1.98	100/500
J1304	71907	10-14	3/4	5/16	1.43	100/500
J1305	80879	10-14	1	5/16	2.06	100/500
J1306	80880	10-14	1 1/2	5/16	2.97	100
J1307	80881	16-18	1	3/8	2.75	100
J1308	80882	16-18	1 1/2	3/8	3.59	100

OTHER SIZES AND QUANTITIES AVAILABLE BY REQUEST

Please note that wood and tapping screw lead anchors have a lead outer gripping shell. In applications where lead is considered dangerous, we do not recommend their use. Until U.S. Govt. Safety Regulations take a firm stand on their use, Metallics will continue to offer this product, As do many other fastener competitors.



\*=acorn nuts

## SLEEVE ANCHORS

STEEL ZINC • 18-8 STAINLESS



Drill Hole

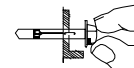

Insert Anchor

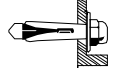

Tighten

PART#	UPC#	DIAMETER	LENGTH	BOLT DIAMETER	FASTENS MATERIAL UP TO	DEPTH IN LENGTH	WT. PER PKG.	STD. PKG. UM
<b>STEEL ZINC – HEX (*ACORN)</b>								
J5125	81137	¼	5/8	3/16	¼	1	.40	100/500
J2505	77405	¼	5/8	3/16	¼	1	1.57	100/500
J2513*	80883	¼	1 3/8	3/16	3/8	1	2.50	100
J2522*	80884	¼	2 ¼	3/16	1 ¼	1	3.14	100
J3114	80885	5/16	1 ½	¼	½	1	3.54	100
J3124	80886	5/16	2 ½	¼	1 ½	1	5.29	100
J3717	80887	3/8	1 7/8	5/16	5/8	1 ¼	3.58	50
J3730	80888	3/8	3	5/16	1 ¾	1 ¼	5.15	50
J3732	77310	3/8	4	5/16	1 ¾	1 ¼	6.71	50
J5022	80889	½	2 ¼	3/8	¾	1 ½	3.24	25
J5026	80890	½	3	3/8	1 ¼	1 ½	4.07	25
J5040	81131	½	4	3/8	2 ½	1 ½	5.02	25
J5060	81135	½	6	3/8	4 ½	1 ½	7.15	25
J6222	80891	5/8	2 ¼	½	¼	2	6.00	25
J6242	81345	5/8	4 ¼	½	2 ¼	2	4.14	10
J6242L	17131	5/8	4 ¼	½	½	2	20.70	50
J6256	81350	5/8	6	½	3 ¾	2	5.30	10
J7524	80892	¾	2 ½	5/8	½	2	4.07	10
J7542	81360	¾	4 ¼	5/8	1 ¾	2 ½	3.23	5
J7542L	17133	¾	4 ¼	5/8	1 ¾	2 ½	32.30	50
J7562	81365	¾	6 ¼	5/8	3 ¾	2 ½	4.75	5
<b>STEEL ZINC – FLAT HEAD</b>								
J2513F	77213	¼	1 3/8	3/16	3/8	1	2.31	100
J2520F	77220	¼	2	3/16	1	1	2.28	100
J2530F	77225	¼	3	3/16	2	1	3.40	100
J2552F	77252	¼	5 ¼	3/16	4	1 ¼	5.90	100
J3726F	77271	3/8	2 ¾	5/16	1	1 ½	8.80	100
J3733F	14804	3/8	5	5/16	3 ½	1 ½	6.82	50
J3735F	14805	3/8	6	5/16	4 ½	1 ½	8.41	50
<b>STEEL ZINC – ROUND HEAD</b>								
J2512R	81089	¼	1 ¼	3/16	¼	1	1.89	100
J2520R	82620	¼	2	3/16	1	1	2.52	100
J2526R	82626	¼	2 ¾	3/16	1	1	3.27	100
<b>18-8 STAINLESS – HEX &amp; (*ACORN)</b>								
J2513SS*	82106	¼	1 3/8	3/16	3/8	1	2.14	100
J2522SS*	82107	¼	2 ¼	3/16	1 ¼	1	3.30	100
J3114SS	82108	5/16	1 ½	¼	½	1	4.50	100
J3124SS	82109	5/16	2 ½	¼	1 ½	1	6.30	100
J3717SS	82111	3/8	1 7/8	5/16	5/8	1 ¼	3.62	50
J3730SS	82112	3/8	3	5/16	1 ¾	1 ¼	4.87	50
J5022SS	82113	½	2 ¼	3/8	¾	1 ½	3.12	25
J5026SS	82114	½	2 ¾	3/8	1 ¼	1 ½	3.88	25
J5030SS	82116	½	3	3/8	1 ½	2	4.02	25
J5040SS	82117	½	4	3/8	2 ½	1 ½	4.78	25
J6222SS	82102	5/8	2 ¼	½	¼	2	6.09	25
J6230SS	82118	5/8	3	½	¼	2	6.60	25
J6242SS	82119	5/8	4 ¼	½	2 ¼	2	4.00	10
J7524SS	82121	¾	2 ½	5/8	½	2	5.00	10
J7542SS	82123	¾	4 ¼	5/8	1 ¾	2 ½	3.50	5
J7554SS	82124	¾	5 ½	5/8	3 ¾	2 ½	4.70	5

OTHER SIZES AND QUANTITIES AVAILABLE BY REQUEST



## WEDGE ANCHORS

DOMESTIC STEEL ZINC • DOMESTIC 18-8 STAINLESS • DOMESTIC 316 STAINLESS  
 STEEL ZINC • 18-8 STAINLESS • 316 STAINLESS • 304 STAINLESS STEEL • GALVANIZED



PART#	UPC#	DRILL DIAMETER	LENGTH	THREAD LENGTH	MIN. DEPTH	WT. PER PKG.	STD. PKG. UM
<b>DOMESTIC STEEL ZINC</b>							
JTS1134D	99918	¼	1¾	1 <sup>3</sup> / <sub>16</sub>	1 <sup>1</sup> / <sub>8</sub>	3.12	100/500
JTS1214D	99919	¼	2¼	1 <sup>7</sup> / <sub>16</sub>	1 <sup>1</sup> / <sub>8</sub>	3.68	100/500
JTS103D	99922	¼	3¼	2 <sup>7</sup> / <sub>16</sub>	1 <sup>1</sup> / <sub>8</sub>	4.57	100/500
JTS516234D	99923	5 <sup>1</sup> / <sub>16</sub>	2¾	1 <sup>1</sup> / <sub>8</sub>	1½	4.69	100/500
JTS5163D	99924	5 <sup>1</sup> / <sub>16</sub>	3	1 <sup>1</sup> / <sub>8</sub>	1½	5.02	100/500
JTS5164D	99925	5 <sup>1</sup> / <sub>16</sub>	4	1 <sup>1</sup> / <sub>8</sub>	1½	6.35	100/500
JTS3218D	99926	3 <sup>1</sup> / <sub>8</sub>	2¼	1 <sup>1</sup> / <sub>8</sub>	1¾	8.05	100/500
JTS3234D	99927	3 <sup>1</sup> / <sub>8</sub>	2¾	1 <sup>5</sup> / <sub>8</sub>	1¾	9.30	100/500
JTS303D	99928	3 <sup>1</sup> / <sub>8</sub>	3	1 <sup>7</sup> / <sub>8</sub>	1¾	9.92	100/500
TS3312D	99929	3 <sup>1</sup> / <sub>8</sub>	3½	2½	1¾	12.82	100
JTS312D	99942	3 <sup>1</sup> / <sub>8</sub>	3¾	2 <sup>5</sup> / <sub>8</sub>	1¾	5.85	50/250
TS385D	99943	3 <sup>1</sup> / <sub>8</sub>	5	3 <sup>7</sup> / <sub>8</sub>	1¾	7.45	50
TS387D	99944	3 <sup>1</sup> / <sub>8</sub>	7	5 <sup>7</sup> / <sub>8</sub>	1¾	10.05	50
JTS4234D	99945	½	2¾	1¼	2¼	9.10	50/250
JTS4334D	99946	½	3¾	2 <sup>5</sup> / <sub>16</sub>	2¼	11.00	50/250
JTS4414D	99947	½	4¼	2 <sup>13</sup> / <sub>16</sub>	2¼	6.12	25/125
TS4512D	99948	½	5½	4 <sup>1</sup> / <sub>16</sub>	2¼	7.28	25
TS407D	99949	½	7	4 <sup>9</sup> / <sub>16</sub>	2¼	9.55	25
TS12812D	99950	½	8½	6	2¼	20.82	25
TS1210D	99951	½	10	6	2¼	27.01	25
TS1212D	99952	½	12	6	2¼	35.00	25
JTS5312D	99953	5 <sup>1</sup> / <sub>8</sub>	3½	1 <sup>7</sup> / <sub>8</sub>	2¾	9.22	25/125
JTS5412D	99954	5 <sup>1</sup> / <sub>8</sub>	4½	2 <sup>7</sup> / <sub>8</sub>	2¾	10.48	25/125
TS505D	99955	5 <sup>1</sup> / <sub>8</sub>	5	3 <sup>3</sup> / <sub>8</sub>	2¾	11.60	25
TS506D	99956	5 <sup>1</sup> / <sub>8</sub>	6	4 <sup>3</sup> / <sub>8</sub>	2¾	9.00	25
TS507D	99957	5 <sup>1</sup> / <sub>8</sub>	7	5 <sup>3</sup> / <sub>8</sub>	2¾	21.00	25
TS508D	99958	5 <sup>1</sup> / <sub>8</sub>	8	6	2¾	22.00	25
TS5810D	99959	5 <sup>1</sup> / <sub>8</sub>	10	6	2¾	25.00	25
TS5812D	99960	5 <sup>1</sup> / <sub>8</sub>	12	6	2¾	31.00	25
JTS6414D	99961	¾	4¼	2 <sup>3</sup> / <sub>8</sub>	3 <sup>3</sup> / <sub>8</sub>	9.44	10
JTS6434D	99962	¾	4¾	2 <sup>7</sup> / <sub>8</sub>	3 <sup>3</sup> / <sub>8</sub>	10.44	10
JTS6512D	99963	¾	5½	3 <sup>5</sup> / <sub>8</sub>	3 <sup>3</sup> / <sub>8</sub>	12.05	10
JTS6614D	99964	¾	6¼	4 <sup>3</sup> / <sub>8</sub>	3 <sup>3</sup> / <sub>8</sub>	14.80	10
TS347D	99965	¾	7	5 <sup>1</sup> / <sub>8</sub>	3 <sup>3</sup> / <sub>8</sub>	15.02	10
TS34812D	99966	¾	8½	6	3 <sup>3</sup> / <sub>8</sub>	17.01	10
TS3410D	99967	¾	10	6	3 <sup>3</sup> / <sub>8</sub>	19.08	10
TS3412D	99968	¾	12	6	3 <sup>3</sup> / <sub>8</sub>	21.00	10
TS786D	99969	7 <sup>1</sup> / <sub>8</sub>	6	2 <sup>1</sup> / <sub>8</sub>	3 <sup>7</sup> / <sub>8</sub>	15.00	10
TS788D	99970	7 <sup>1</sup> / <sub>8</sub>	8	2 <sup>1</sup> / <sub>8</sub>	3 <sup>7</sup> / <sub>8</sub>	17.01	10
TS7810D	99971	7 <sup>1</sup> / <sub>8</sub>	2 <sup>1</sup> / <sub>8</sub>	2¼	3 <sup>7</sup> / <sub>8</sub>	19.20	10
TS671D	99972	1	6	2¼	4½	2.40	5
TS6701D	99973	1	9	2¼	4½	2.45	5
TS6712D	99974	1	12	2¼	4½	3.05	5
<b>DOMESTIC 18-8 STAINLESS</b>							
JTS1134SSD	84201	¼	1¾	1 <sup>5</sup> / <sub>16</sub>	1 <sup>1</sup> / <sub>8</sub>	3.10	100/500
JTS1214SSD	84202	¼	2¼	1 <sup>7</sup> / <sub>16</sub>	1 <sup>1</sup> / <sub>8</sub>	3.70	100/500
JTS103SSD	99810	¼	3¼	2 <sup>7</sup> / <sub>16</sub>	1 <sup>1</sup> / <sub>8</sub>	2.20	50/250
JTS3218SSD	84203	3 <sup>1</sup> / <sub>8</sub>	2¼	1 <sup>1</sup> / <sub>8</sub>	1¾	8.04	50/250
JTS3234SSD	84204	3 <sup>1</sup> / <sub>8</sub>	2¾	1 <sup>5</sup> / <sub>8</sub>	1¾	9.30	100/500
JTS303SSD	84205	3 <sup>1</sup> / <sub>8</sub>	3	1 <sup>7</sup> / <sub>8</sub>	1¾	5.07	50/250
JTS3312SSD	84206	3 <sup>1</sup> / <sub>8</sub>	3½	2½	1¾	12.81	100/500
JTS3121SSD	84207	3 <sup>1</sup> / <sub>8</sub>	3¾	2 <sup>5</sup> / <sub>8</sub>	1¾	5.99	50/250
TS385SSD	84208	3 <sup>1</sup> / <sub>8</sub>	5	3 <sup>7</sup> / <sub>8</sub>	1¾	7.38	50
TS387SSD	84209	3 <sup>1</sup> / <sub>8</sub>	7	5 <sup>7</sup> / <sub>8</sub>	1	5.38	25

OTHER SIZES AND QUANTITIES AVAILABLE BY REQUEST



CONTINUED

## WEDGE ANCHORS

DOMESTIC STEEL ZINC • DOMESTIC 18-8 STAINLESS • DOMESTIC 316 STAINLESS  
STEEL ZINC • 18-8 STAINLESS • 316 STAINLESS • 304 STAINLESS STEEL • GALVANIZED



PART#	UPC#	DRILL DIAMETER	LENGTH	THREAD LENGTH	MIN. DEPTH	WT. PER PKG.	STD. PKG. UM
<b>DOMESTIC 18-8 STAINLESS</b>							
JTS4234SSD	84210	½	2¾	1¼	2¼	4.11	25
JTS4334SSD	84211	½	3¾	2 <sup>5</sup> / <sub>16</sub>	2¼	5.77	25
JTS4414SSD	84212	½	4¾	2 <sup>13</sup> / <sub>16</sub>	2¼	6.20	25
TS4512SSD	84213	½	5½	4 <sup>1</sup> / <sub>16</sub>	2¼	7.62	25
JTS407SSD	84214	½	7	4 <sup>9</sup> / <sub>16</sub>	2¼	9.98	25
TS4812SSD	84215	½	8½	6	2¼	20.82	25
TS6618SSD	84216	½	10	6	2¼	26.00	25
TS1212SSD	84217	½	12	6	2¼	33.00	25
JTS5312SSD	81612	5/8	3½	1 <sup>7</sup> / <sub>8</sub>	2¾	10.22	25
TS5412SSD	84219	5/8	4½	2 <sup>7</sup> / <sub>8</sub>	2¾	10.58	25
TS505SSD	84220	5/8	5	3 <sup>3</sup> / <sub>8</sub>	2¾	11.60	25
TS506SSD	84221	5/8	6	4 <sup>3</sup> / <sub>8</sub>	2¾	19.00	25
TS587	84222	5/8	7	4 <sup>9</sup> / <sub>16</sub>	2¾	15.96	25
TS508SSD	84223	5/8	8½	6	2¾	22.68	25
TS5810SSD	84224	5/8	10	6	2¾	25.00	25
TS5812SSD	84225	5/8	12	6	2¾	31.00	25
JTS6414SSD	84226	¾	4¾	2 <sup>3</sup> / <sub>8</sub>	3 <sup>3</sup> / <sub>8</sub>	18.88	20
JTS6434SSD	84227	¾	4¾	2 <sup>7</sup> / <sub>8</sub>	3 <sup>3</sup> / <sub>8</sub>	13.27	20
TS6512SSD	84228	¾	5½	3 <sup>5</sup> / <sub>8</sub>	3 <sup>3</sup> / <sub>8</sub>	24.10	20
TS6614SSD	84229	¾	6¾	4 <sup>3</sup> / <sub>8</sub>	3 <sup>3</sup> / <sub>8</sub>	29.60	20
TS607SSD	84230	¾	7	5 <sup>1</sup> / <sub>8</sub>	3 <sup>3</sup> / <sub>8</sub>	15.02	10
TS3485SSD	84231	¾	8½	6	3 <sup>3</sup> / <sub>8</sub>	17.01	10
TS3410SSD	84232	¾	10	6	3 <sup>3</sup> / <sub>8</sub>	19.08	10
TS3412SSD	84233	¾	12	6	3 <sup>3</sup> / <sub>8</sub>	21.00	10
<b>DOMESTIC 316 STAINLESS</b>							
JTS11341SSD	84234	¼	1¾	1 <sup>5</sup> / <sub>16</sub>	1/8	3.10	100/500
JTS1024SSD	84235	¼	2¼	1 <sup>7</sup> / <sub>16</sub>	1/8	3.70	100/500
JTS1034SSD	84236	¼	3¼	2 <sup>7</sup> / <sub>16</sub>	1/8	5.54	100/500
JTS32181SSD	84237	3/8	2¼	1 <sup>1</sup> / <sub>8</sub>	1¾	8.04	100/500
JTS32341SSD	84238	3/8	2¾	1 <sup>5</sup> / <sub>8</sub>	1¾	9.30	100/500
JTS3031SSD	84239	3/8	3	1 <sup>7</sup> / <sub>8</sub>	1¾	10.14	100/500
TS33121SSD	84240	3/8	3½	2½	1¾	12.81	100/500
JTS31211SSD	84241	3/8	3¾	2 <sup>5</sup> / <sub>8</sub>	1¾	5.96	50/250
TS3851SSD	84242	3/8	5	3 <sup>7</sup> / <sub>8</sub>	1¾	7.38	50/250
TS3871SSD	84243	3/8	7	5 <sup>7</sup> / <sub>8</sub>	1¾	6.08	25/125
JTS42341SSD	84244	½	2¾	1¼	2¼	4.11	25/125
JTS43341SSD	84245	½	3¾	2 <sup>5</sup> / <sub>16</sub>	2¼	5.77	25/125
JTS44141SSD	84246	½	4¾	2 <sup>13</sup> / <sub>16</sub>	2¼	6.21	25/125
TS45121SSD	84247	½	5½	4 <sup>1</sup> / <sub>16</sub>	2¼	7.62	25/125
JTS4071SSD	84248	½	7	4 <sup>9</sup> / <sub>16</sub>	2¼	9.98	25/125
TS48121SSD	84249	½	8½	6	2¼	20.82	25/125
TS66181SSD	84250	½	10	6	2¼	26.00	25/125
TS12121SSD	84251	½	12	6	2¼	33.00	25/125
JTS53121SSD	84252	5/8	3½	1 <sup>7</sup> / <sub>8</sub>	2¾	10.22	25/125
JTS54121SSD	84253	5/8	4½	2 <sup>7</sup> / <sub>8</sub>	2¾	10.58	25/125
TS5051SSD	84254	5/8	5	3 <sup>3</sup> / <sub>8</sub>	2¾	11.70	25/125
TS5061SSD	84255	5/8	6	4 <sup>3</sup> / <sub>8</sub>	2¾	13.49	25/125
TS5871SSD	84256	5/8	7	5 <sup>3</sup> / <sub>8</sub>	2¾	15.96	25/125
TS5081SSD	84257	5/8	8½	6	2¾	18.27	25/125
TS58101SSD	84258	5/8	10	6	2¾	21.36	25/125
TS58121SSD	84259	5/8	12	6	2¾	27.00	25/125
JTS64141SSD	84260	¾	4¾	2 <sup>3</sup> / <sub>8</sub>	3 <sup>3</sup> / <sub>8</sub>	13.09	20/100
JTS64341SSD	84261	¾	4¾	2 <sup>7</sup> / <sub>8</sub>	3 <sup>3</sup> / <sub>8</sub>	13.78	20/100
TS65121SSD	84262	¾	5½	3 <sup>5</sup> / <sub>8</sub>	3 <sup>3</sup> / <sub>8</sub>	14.76	20/100

OTHER SIZES AND QUANTITIES AVAILABLE BY REQUEST



CONTINUED

## WEDGE ANCHORS

DOMESTIC STEEL ZINC • DOMESTIC 18-8 STAINLESS • DOMESTIC 316 STAINLESS  
STEEL ZINC • 18-8 STAINLESS • 316 STAINLESS • 304 STAINLESS STEEL • GALVANIZED



PART#	UPC#	DRILL DIAMETER	LENGTH	THREAD LENGTH	MIN. DEPTH	WT. PER PKG.	STD. PKG. UM
<b>DOMESTIC 316 STAINLESS</b>							
TS6614ISSD	84263	3/4	6 1/4	4 3/8	3 3/8	19.20	20/100
TS6071SSD	84264	3/4	7	5 1/8	3 3/8	10.00	10/50
TS34851SSD	84265	3/4	8 1/2	6	3 3/8	12.30	10/50
<b>STEEL ZINC</b>							
JTS1134	80893	1/4	1 3/4	1 5/16	1 1/8	3.12	100
JTS1214	80894	1/4	2 1/4	1 7/16	1 1/8	3.68	100
JTS103	80895	1/4	3 1/4	2 7/16	1 1/8	4.57	100
TS5234	32037	5/16	2 3/4	1 1/8	1 1/2	4.69	100
TS5164	98351	5/16	4	1 1/8	1 1/2	9.21	100
JTS3218	80896	3/8	2 1/4	1 1/8	1 3/4	8.05	100
JTS3234	81165	3/8	2 3/4	1 5/8	1 3/4	9.30	100
JTS303	80898	3/8	3	1 7/8	1 3/4	9.92	100
TS3312	32007	3/8	3 1/2	2 1/2	1 3/4	12.81	100
JTS312	80899	3/8	3 3/4	2 5/8	1 3/4	5.85	50
TS312CCL	27176	3/8	3 3/4	2 5/8	1 3/4	29.03	250
TS385	32014	3/8	5	3 7/8	1 3/4	7.45	50
TS3612	81615	3/8	6 1/2	4	1 3/4	9.85	50
JTS4234	81166	1/2	2 3/4	1 5/16	2 1/4	9.10	50
TS4234M	39236	1/2	2 3/4	1 5/16	2 1/4	182.00	1000
JTS4334	81770	1/2	3 3/4	2 5/16	2 1/4	11.00	50
TS4334C	27177	1/2	3 3/4	2 5/16	2 1/4	22.36	100
JTS4414	81622	1/2	4 1/4	2 13/16	2 1/4	6.12	25
TS4414C	27178	1/2	4 1/4	2 13/16	2 1/4	24.30	100
JTS4512	81623	1/2	5 1/2	4 1/16	2 1/4	7.28	25
TS407	32033	1/2	7	4 9/16	2 1/4	9.55	25
TS4812	32050	1/2	8 1/2	6	2 1/4	20.82	25
JTS5312	81630	5/8	3 1/2	1 7/8	2 3/4	9.22	25
JTS5412	81631	5/8	4 1/2	2 7/8	2 3/4	10.48	25
TS505	81632	5/8	5	3 3/8	2 3/4	11.60	25
TS506	81633	5/8	6	4 3/8	2 3/4	19.00	25
TS507	81634	5/8	7	5 3/8	2 3/4	6.38	10
TS508	32035	5/8	8 1/2	6	2 3/4	7.88	10
TS510	81628	5/8	10	6	2 3/4	8.54	10
TS512	81629	5/8	12	6	2 3/4	2.16	5
JTS6414	81640	3/4	4 1/4	2 3/8	3 3/8	12.09	20
JTS6434	32041	3/4	4 3/4	2 7/8	3 3/8	14.00	20
TS6512	32042	3/4	5 1/2	3 5/8	3 3/8	14.70	20
JTS6614	81643	3/4	6 1/4	4 3/8	3 3/8	8.25	10
JTS607	32053	3/4	7	5 1/8	3 3/8	15.02	10
TS6812	32054	3/4	8 1/2	6	3 3/8	17.01	10
TS610	32055	3/4	10	6	3 3/8	19.08	10
TS612	32056	3/4	12	6	3 3/8	21.00	5
TS786	32062	7/8	6	2 1/8	3 7/8	15.00	5
TS788	32063	7/8	8	2 1/8	3 7/8	17.01	5
TS7810	32078	7/8	10	2 1/8	3 7/8	19.20	5
TS106	32076	1	6	2 1/4	4 1/2	2.40	5
TS6701	32045	1	9	2 3/4	4 1/2	2.45	5
<b>STEEL ZINC</b>							
TS112	32078	1	12	2 3/4	4 1/2	3.05	5
TS115	32079	1	15	2 3/4	4 1/2	5.17	5
<b>18-8 STAINLESS</b>							
JTS1134SS	80900	1/4	1 3/4	1 5/16	1 1/8	1.55	50
JTS1214SS	80901	1/4	2 1/4	1 7/16	1 1/8	1.85	50
JTS103SS	80902	1/4	3 1/4	2 7/16	1 1/8	2.50	50

OTHER SIZES AND QUANTITIES AVAILABLE BY REQUEST

CONTINUED ON NEXT PAGE

[www.metallics.us](http://www.metallics.us)

CONTINUED

## WEDGE ANCHORS

DOMESTIC STEEL ZINC • DOMESTIC 18-8 STAINLESS • DOMESTIC 316 STAINLESS  
STEEL ZINC • 18-8 STAINLESS • 316 STAINLESS • 304 STAINLESS STEEL • GALVANIZED



PART#	UPC#	DRILL DIAMETER	LENGTH	THREAD LENGTH	MIN. DEPTH	WT. PER PKG.	STD. PKG. UM
<b>18-8 STAINLESS</b>							
JTS144SS	71751	¼	4	2 <sup>7</sup> / <sub>16</sub>	1 <sup>1</sup> / <sub>8</sub>	3.13	50
JTS3218SS	80903	3 <sup>3</sup> / <sub>8</sub>	2¼	1 <sup>1</sup> / <sub>8</sub>	1¾	4.02	50
JTS3234SS	81157	3 <sup>3</sup> / <sub>8</sub>	2¾	1 <sup>5</sup> / <sub>8</sub>	1¾	9.30	100
JTS303SS	80904	3 <sup>3</sup> / <sub>8</sub>	3	1 <sup>7</sup> / <sub>8</sub>	1¾	5.07	50
TS3312SS	81158	3 <sup>3</sup> / <sub>8</sub>	3½	2½	1¾	12.82	100
JTS312SS	80905	3 <sup>3</sup> / <sub>8</sub>	3¾	2 <sup>5</sup> / <sub>8</sub>	1¾	5.96	50
JTS385SS	95250	3 <sup>3</sup> / <sub>8</sub>	5	3 <sup>7</sup> / <sub>8</sub>	1¾	7.38	50
JTS3612SS	95255	3 <sup>3</sup> / <sub>8</sub>	6½	4	1¾	5.19	25
JTS4234SS	82126	½	2¾	1¼	2¼	4.11	25
JTS4334SS	82127	½	3¾	2 <sup>5</sup> / <sub>16</sub>	2¼	5.77	25
JTS4414SS	32028	½	4¼	2 <sup>13</sup> / <sub>16</sub>	2¼	6.21	25
JTS4512SS	95260	½	5½	4 <sup>1</sup> / <sub>16</sub>	2¼	7.62	25
JTS407SS	82125	½	7	4 <sup>9</sup> / <sub>16</sub>	2¼	9.98	25
TS4085SS	81159	½	8½	6	2¼	20.82	25
JTS5312SS	82523	5 <sup>5</sup> / <sub>8</sub>	3½	1 <sup>7</sup> / <sub>8</sub>	2¾	10.22	25
JTS5412SS	82524	5 <sup>5</sup> / <sub>8</sub>	4½	2 <sup>7</sup> / <sub>8</sub>	2¾	10.58	25
TS505SS	82525	5 <sup>5</sup> / <sub>8</sub>	5	3 <sup>3</sup> / <sub>8</sub>	2¾	11.70	25
TS506SS	82526	5 <sup>5</sup> / <sub>8</sub>	6	4 <sup>3</sup> / <sub>8</sub>	2¾	13.49	25
TS507SS	82527	5 <sup>5</sup> / <sub>8</sub>	7	5 <sup>3</sup> / <sub>8</sub>	2¾	15.96	10
TS508SS	82528	5 <sup>5</sup> / <sub>8</sub>	8½	6	2¾	18.27	10
TS510SS	82529	5 <sup>5</sup> / <sub>8</sub>	10	6	2¾	8.55	10
TS512SS	82530	5 <sup>5</sup> / <sub>8</sub>	12	6	2¾	5.42	5
JTS6414SS	90324	¾	4¼	2 <sup>3</sup> / <sub>8</sub>	3 <sup>3</sup> / <sub>8</sub>	9.44	10
JTS6434SS	32085	¾	4¾	2 <sup>7</sup> / <sub>8</sub>	3 <sup>3</sup> / <sub>8</sub>	13.27	20
TS6512SS	32086	¾	5½	3 <sup>5</sup> / <sub>8</sub>	3 <sup>3</sup> / <sub>8</sub>	24.10	20
TS6614SS	32048	¾	6¼	4 <sup>3</sup> / <sub>8</sub>	3 <sup>3</sup> / <sub>8</sub>	14.80	10
JTS607SS	90308	¾	7	5 <sup>1</sup> / <sub>8</sub>	3 <sup>3</sup> / <sub>8</sub>	15.02	10
TS6812SS	32087	¾	8½	6	3 <sup>3</sup> / <sub>8</sub>	17.01	10
TS610SS	32088	¾	10	3¼	3 <sup>3</sup> / <sub>8</sub>	19.08	10
TS612SS	32089	¾	12	2¼	3 <sup>3</sup> / <sub>8</sub>	10.51	5
TS786SS	32066	7 <sup>7</sup> / <sub>8</sub>	6	2 <sup>1</sup> / <sub>8</sub>	3 <sup>7</sup> / <sub>8</sub>	15.00	5
TS106SS	32081	1	6	2¼	4½	2.40	5
TS109SS	32082	1	9	2¼	4½	2.45	5
TS112SS	32083	1	12	2¼	4½	3.05	5
<b>316 STAINLESS</b>							
JTS11340SS	81163	¼	1¾	1 <sup>5</sup> / <sub>16</sub>	1 <sup>1</sup> / <sub>8</sub>	3.10	100
JTS1024SS	90292	¼	2¼	1 <sup>7</sup> / <sub>16</sub>	1 <sup>1</sup> / <sub>8</sub>	3.70	100
JTS1034SS	90298	¼	3¼	2 <sup>7</sup> / <sub>16</sub>	1 <sup>1</sup> / <sub>8</sub>	5.54	100
JTS1044SS	90314	¼	4	2 <sup>7</sup> / <sub>16</sub>	1 <sup>1</sup> / <sub>8</sub>	7.97	100
TS32180SS	81291	3 <sup>3</sup> / <sub>8</sub>	2¼	1 <sup>1</sup> / <sub>8</sub>	1¾	8.04	100
JTS32340SS	81292	3 <sup>3</sup> / <sub>8</sub>	2¾	1 <sup>5</sup> / <sub>8</sub>	1¾	9.30	100
JTS3033SS	90305	3 <sup>3</sup> / <sub>8</sub>	3	1 <sup>7</sup> / <sub>8</sub>	1¾	5.30	50
TS33120SS	81293	3 <sup>3</sup> / <sub>8</sub>	3½	2½	1¾	12.82	100
JTS3121SS	81164	3 <sup>3</sup> / <sub>8</sub>	3¾	2 <sup>5</sup> / <sub>8</sub>	1¾	5.99	50
TS3850SS	81294	3 <sup>3</sup> / <sub>8</sub>	5	3 <sup>7</sup> / <sub>8</sub>	1¾	7.38	50
JTS43340SS	81308	½	3¾	2 <sup>5</sup> / <sub>16</sub>	2¼	5.77	25
JTS4414316SS	95261	½	4¼	2 <sup>13</sup> / <sub>16</sub>	2¼	6.55	25
TS45120SS	81309	½	5½	4 <sup>1</sup> / <sub>16</sub>	2¼	5.77	25
TS4070SS	81310	½	7	4 <sup>9</sup> / <sub>16</sub>	2½	5.77	25
JTS53120SS	81337	5 <sup>5</sup> / <sub>8</sub>	3½	1 <sup>7</sup> / <sub>8</sub>	2¾	10.22	25
JTS54120SS	81338	5 <sup>5</sup> / <sub>8</sub>	4½	2 <sup>7</sup> / <sub>8</sub>	2¾	10.58	25
TS5050SS	81339	5 <sup>5</sup> / <sub>8</sub>	5	3 <sup>3</sup> / <sub>8</sub>	2¾	11.70	25
TS5060SS	81340	5 <sup>5</sup> / <sub>8</sub>	6	4 <sup>3</sup> / <sub>8</sub>	2¾	13.49	25
TS5070SS	81341	5 <sup>5</sup> / <sub>8</sub>	7	5 <sup>3</sup> / <sub>8</sub>	2¾	15.96	10
TS5080SS	81342	5 <sup>5</sup> / <sub>8</sub>	8	2	2¾	18.20	10

OTHER SIZES AND QUANTITIES AVAILABLE BY REQUEST

CONTINUED ON NEXT PAGE  
[www.metallics.us](http://www.metallics.us)

CONTINUED

## WEDGE ANCHORS



DOMESTIC STEEL ZINC • DOMESTIC 18-8 STAINLESS • DOMESTIC 316 STAINLESS  
STEEL ZINC • 18-8 STAINLESS • 316 STAINLESS • 304 STAINLESS STEEL • GALVANIZED

PART#	UPC#	DRILL DIAMETER	LENGTH	THREAD LENGTH	MIN. DEPTH	WT. PER PKG.	STD. PKG. UM
<b>316 STAINLESS</b>							
TS64340SS	81353	3/4	4 3/4	2 7/8	3 3/8	13.27	20
TS65120SS	81354	3/4	5 1/2	3 5/8	3 3/8	24.10	20
TS66140SS	81355	3/4	6 1/4	4 3/8	3 3/8	29.60	20
TS6070SS	81356	3/4	7	5 1/8	3 3/8	30.04	20
<b>GALVANIZED</b>							
JTS1134G	81133	1/4	2 1/4	1 7/16	1 1/8	3.72	100
JTS103G	81134	1/4	3 1/4	2 7/16	1 1/8	4.60	100
JTS380G	81192	3/8	2 1/4	1 1/8	1 3/4	4.60	50
JTS3234G	81256	3/8	2 3/4	1 1/8	1 3/4	9.21	100
JTS383G	81193	3/8	3	1 1/8	1 3/4	5.08	50
JTS3312G	81256	3/8	3 1/2	1 1/8	1 3/4	12.83	100
TS312G	81258	3/8	3 3/4	1 1/8	1 3/4	11.70	100
TS385G	81259	3/8	5	1 1/8	1 3/4	14.90	100
JTS4234G	81167	1/2	2 3/4	1 1/4	2 1/4	8.11	50
JTS4414G	81380	1/2	4 1/4	2 13/16	2 1/4	6.35	25
JTS4512G	81381	1/2	5 1/2	4 1/16	2 1/4	7.31	25
TS407G	81382	1/2	7	4 9/16	2 1/4	9.57	25
TS4085G	81169	1/2	8 1/2	6	2 1/4	20.84	25
TS6618G	81383	1/2	10	6	2 1/4	20.81	20
JTS5312G	81194	5/8	3 1/2	1 7/8	2 3/4	9.44	25
JTS5412G	81636	5/8	4 1/2	2 7/8	2 3/4	10.25	25
TS505G	81392	5/8	5	3 3/8	2 3/4	11.73	25
TS506G	81393	5/8	6	4 3/8	2 3/4	13.51	25
TS507G	81394	5/8	7	5 3/8	2 3/4	15.98	10
TS508G	81395	5/8	8 1/2	6	2 3/4	18.33	10
JTS510G	81396	5/8	10	6	2 3/4	8.57	10
JTS6434G	81361	3/4	4 3/4	2 7/8	3 7/8	13.29	20
TS34512G	10472	3/4	5 1/2	3 5/8	3 7/8	24.12	20
JTS6614G	81362	3/4	6 1/4	4 3/8	3 7/8	14.83	10
JTS607G	81638	3/4	7	5 1/8	3 7/8	15.05	10
TS6812G	81363	3/4	8 1/2	6	3 7/8	17.03	10
TS610G	81364	3/4	10	6	3 7/8	19.11	10
TS788G	81412	7/8	8	2 1/8	3 7/8	17.16	5
TS106G	81425	1	6	2 1/4	4 1/2	2.42	5
TS109G	81426	1	9	2 1/4	4 1/2	2.48	5

OTHER SIZES AND QUANTITIES AVAILABLE BY REQUEST

## POWERS® STUD PLUS SD1 HEX HEAD WEDGE TYPE EXPANSION ANCHOR

CARBON STEEL ZINC



PART#	UPC#	DIAMETER	LENGTH	WT. PER PKG.	STD. PKG. UM
M7206SD	23611	1/4	1 3/4	3.12	100
M7409SD1	39438	1/4	2	3.00	100
M7402SD1	39439	1/4	2 1/4	4.00	100
M7412SD1	39442	3/8	2 3/4	9.30	100
M7413SD1	23588	3/8	3	9.92	100



## HAMMER DRIVE WEDGE ANCHORS

STEEL ZINC

A superior alternative to traditional wedge anchors

- Installs six times faster than an ordinary wedge-type anchor.
- Easily installs through pre-drilled holes in plates and footings – no need for templates.
- No special tools required.
- Tensions during setting process.
- Deforms the concrete to set, eliminating creep and loss of pre-load.
- Faster, easier and more consistent installation.

PART#	UPC#	DRILL DIAMETER	LENGTH	THREAD LENGTH	DRILL SIZE	WT. PER PKG.	STD. PKG. UM
<b>ZINC CHROMATE</b>							
JHW14134	80907	1/4	1 3/4	5/8	1/4	1.72	50
JHW14238	80908	1/4	2 3/8	3/4	1/4	2.05	50
JHW5162	80909	5/16	2	3/4	5/16	2.70	50
JHW516234	80910	5/16	2 3/4	1	5/16	3.51	50
JHW38238	80911	3/8	2 3/8	1	3/8	4.35	50
JHW38312	80912	3/8	3 1/2	1 1/8	3/8	6.05	50
JHW38434	82630	3/8	4 3/4	1 1/8	3/8	8.30	50
JHW12234	82635	1/2	2 3/4	1/2	1/2	4.80	25
JHW12312	82640	1/2	3 1/2	1/2	1/2	5.92	25
JHW12434	82645	1/2	4 3/4	2	1/2	7.46	25
JHW126	82650	1/2	6	2	1/2	9.07	25
JHW584	82655	5/8	4	1 5/8	5/8	10.76	25
JHW58434	82660	5/8	4 3/4	1 5/8	5/8	12.22	25
JHW586	82665	5/8	6	2	5/8	6.03	10
JHW345	82670	3/4	5	2	3/4	7.36	10
JHW346	82675	3/4	6	2	3/4	8.39	10
JHW34712	82680	3/4	7 1/2	2	3/4	9.21	10

OTHER SIZES AND QUANTITIES AVAILABLE BY REQUEST

## WEDGE ANCHORS STRONG-BOLT™

STEEL ZINC



For Cracked and Uncracked Concrete

- Tri-Segmented clip is able to adjust independently increasing follow-up expansion should the hole increase in size as a result of a crack.
- 316 stainless clip with superior corrosion resistance.
- Head is stamped with Simpson Strong-Tie® "S" sign and size ID.
- Carbon-steel zinc plated stud with 316 stainless-steel clip.

### SELECTION GUIDE

PART#	THREAD (THREADS) LENGTH PER INCH	DRILL SIZE	OVERALL LENGTH	
SWA3830	1 1/4	16	3/8	3
SWA3836	2 3/8	16	3/8	3 3/4
SWA3850	3 5/8	16	3/8	5
SWA1236	2 1/8	13	1/2	3 3/4
SWA1244	2 7/8	13	1/2	4 1/4
SWA1254	3 7/8	13	1/2	5 1/2
SWA1270	5 3/8	13	1/2	7
SWA5850	3 3/16	11	5/8	5
SWA5860	4 3/16	11	5/8	6
SWA5870	5 3/16	11	5/8	7
SWA5884	5 3/4	11	5/8	8 1/2

### TEST CRITERIA:

Strong-Bolt™ Wedge anchor has been tested in accordance with ICC-ES's *Acceptance Criteria for Mechanical Anchors in Concrete Elements (AC193)* and *ACI 355.2* for the following in cracked and uncracked concrete:

- Static tension and shear loading in cracked and uncracked concrete
- Seismic and wind loading in cracked and uncracked concrete
- Performance in cracked concrete
- Performance in lightweight concrete over metal deck

**CODES:** ICC-ES ESR-1771; City of L.A. RR25705; Florida FL 11506.6

PART#	UPC#	DIAMETER	LENGTH	WT. PER PKG.	STD. PKG. UM
SWA3830	14978	3/8	3	4.94	50
SWA3836	14981	3/8	3 3/4	5.92	50
SWA3850	14986	3/8	5	7.36	50
SWA1236	15451	1/2	3 3/4	5.77	25
SWA1244	15454	1/2	4 1/4	6.00	25
SWA1254	15458	1/2	5 1/2	7.53	25
SWA1270	15463	1/2	7	9.32	25
SWA5850	16236	5/8	5	4.69	10
SWA5860	16239	5/8	6	5.37	10
SWA5870	16243	5/8	7	7.60	10
SWA5884	16247	5/8	8 1/2	8.40	10

## WALLCLAW® HAMMER-IN DRYWALL ANCHORS

NYLON

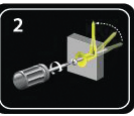
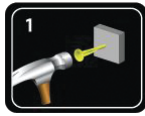

INSTALLATION

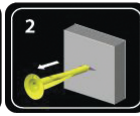
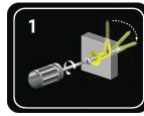

REMOVAL



- No drilling required
- Installs in seconds
- Industrial strength
- Easy to remove
- Leaves only small slit
- Works in 1/2" and 5/8" Sheet Rock
- Commercial Loads – 90 lbs. (1/2") and 125 lbs. (5/8")

- Recommended Hanging (Shear) Loads Include Safety Factor
- Same WallClaw anchor works in both 1/2" and 5/8" drywall
- Accurate placement with the nail tip
- Clamps to back of wall for a secure hold
- Stronger - more surface area in contact with back of wall

- USA made
- Hammer-in drywall anchor
- Safety rating 1/2" drywall = 90 lbs
- Safety rating 5/8" drywall = 125 lbs
- Clamps to wall – both front and back
- Super strong engineered nylon
- Removable anchor (Reusable in the same hole)

PART#	UPC#	WT. PER PKG.	STD. PKG. UM
MWCA25	83721	.28	25
MWCA50	83723	.52	50
MWCA100	83727	.99	100
MWCA500	83728	4.95	500

OTHER SIZES AND QUANTITIES AVAILABLE BY REQUEST

WALLCLAW ANCHORS IS A TRADEMARK OF WALLCLAW ANCHORS, LLC

E

## HAND DRIVE PINS

STEEL ZINC



PART#	UPC#	HEAD SIZE	LENGTH	WT. PER PKG.	STD. PKG. UM
JDPL1	81606	1/4	1/2	.12	50/250
JDP1	80916	1/4	1/2	.46	100/500
JDP2	80917	1/4	3/4	.56	100/500
JDP3	80918	1/4	1	.72	100/500
JDP4	80919	1/4	1 1/4	.80	100/500
JDP5	80920	1/4	1 1/2	.87	100/500
JDP6	80921	1/4	2	1.18	100/500
JDP7	80922	1/4	2 1/2	1.28	100/500
JDP8	81595	1/4	3	1.32	100/500

OTHER SIZES AND QUANTITIES AVAILABLE BY REQUEST

## HAMMER DRIVE NAIL-IN ANCHORS

STEEL ZINC • 18-8 STAINLESS



PART#	UPC#	DIAMETER	LENGTH	HOLE SIZE	WT. PER PKG	STD. PKG. UM
<b>STEEL ZINC</b>						
JNA316	80923	3/16	7/8	3/16	.98	100/500
JNA140	80924	1/4	3/4	1/4	1.59	100/500
NA140M	19485	1/4	3/4	1/4	15.90	1000
JNA141	80925	1/4	1	1/4	1.95	100/500
NA141M	90322	1/4	1	1/4	19.50	1000
NA1415M	75044	1/4	1	1/4	97.50	5000
NA14110M	74476	1/4	1	1/4	195.00	10000
JNA1414	80926	1/4	1 1/4	1/4	2.11	100
NA1414V	19462	1/4	1 1/4	1/4	10.55	500
JNA1415	80927	1/4	1 1/2	1/4	2.37	100
JNA142	80928	1/4	2	1/4	2.98	100
JNA143	80867	1/4	3	1/4	4.08	100
<b>18-8 STAINLESS</b>						
JNA141SS	90387	1/4	1	1/4	1.94	100
JNA1414SS	81987	1/4	1 1/4	1/4	2.25	100
JNA142SS	91381	1/4	2	1/4	3.33	100

OTHER SIZES AND QUANTITIES AVAILABLE BY REQUEST



## HAND DRIVE TOOL

For Hand Drive Pins



PART#	UPC#	WT. PER PKG.	STD. PKG. UM
HDT2	18720	.51	1

## ASSORTED PLASTIC ANCHORS

### "Big Red" Conical Plastic Anchor



PART#	UPC#	LENGTH	SCREW SIZE	HOLE SIZE	WT. PER PKG.	STD. PKG. UM
JRA1	80929	3/4	6-8	3/16	.10	100/500
JRA15	80930	7/8	8-10	3/16	.10	100/500
JRA2	80931	1	10-12	1/4	.18	100/500
RA22M	50086	1	10-12	1/4	2.53	2000
JRA3	80932	1 1/2	12-14	5/16	.31	100/500

OTHER SIZES AND QUANTITIES AVAILABLE BY REQUEST

### "Denver Blue" Conical Plastic Anchor



PART#	UPC#	LENGTH	SCREW SIZE	HOLE SIZE	WT. PER PKG.	STD. PKG. UM
JBA1	80933	3/4	6-8	3/16	.10	100/500
JBA15	80934	7/8	8-10	3/16	.09	100/500
JBA2	80935	1	10-12	1/4	.17	100/500
BA2M	19814	1	10-12	1/4	1.42	1000
JBA3	80936	1 1/2	12-14	5/16	.28	100/500

OTHER SIZES AND QUANTITIES AVAILABLE BY REQUEST

### "Super Yellow" Plastic Wall Anchor



PART#	UPC#	LENGTH	SCREW SIZE	HOLE SIZE	WT. PER PKG.	STD. PKG. UM
JSYA316	80940	1	6-8	3/16	.13	100/500
JSYA14	80941	1 1/4	8-10	1/4	.18	100/500
SYA14B	90205	1 1/4	8-10	1/4	13.21	10000
JSYA516	80942	1 5/8	12-14	5/16	.27	100/500

OTHER SIZES AND QUANTITIES AVAILABLE BY REQUEST

### "Gray Ribbed" Plastic Anchor



PART#	UPC#	LENGTH	SCREW SIZE	HOLE SIZE	WT. PER PKG.	STD. PKG. UM
JGA1	80953	7/8	6-8	3/16	.13	100/500
JGA2	80954	1	10-12	1/4	.18	100/500
JGA3	80955	1 1/4	14-16	5/16	.24	100/500
J1101	71901	Yellow 1	6-8	3/16	.03	100/500
J1105	71902	Red 1 1/2	8-10	15/64	.30	100/500
J1106	80945	Green 1	10-12	1/4	.25	100/500
J1107	80946	Green 1 1/4	10-12	1/4	.27	100/500
J1108	80947	Green 1 1/2	10-12	1/4	.35	100/500
J1109	71903	Green 2	10-12	1/4	.37	100/500
J1110	80948	Blue 1	14	5/16	.31	100/500
J1111	80949	Blue 1 1/2	14	5/16	.41	100/500
J1112	71904	Blue 2	14	5/16	.51	100/500
J1114	80950	Orange 1 1/2	16-5/16	3/8	.39	50/250
J1115	80951	Orange 2	16-5/16	3/8	.50	50
J1116	80952	Orange 2 1/2	16-5/16	3/8	.67	50
J1119	71905	Gray 3	7/16	3/8	.47	50
J1120	71906	Black 2 1/2	9/16	1/2	.59	50

other sizes and quantities available by request

### "Expandet Nylon" Anchor



PART#	UPC#	COLOR/LENGTH	SCREW SIZE	HOLE SIZE	WT. PER PKG.	STD. PKG. UM
JELR2	80943	Red 1 1/2	8	1/4	.26	100/500
JELR3	80944	Blue 1 1/4	12	5/16	.48	100/500

OTHER SIZES AND QUANTITIES AVAILABLE BY REQUEST



**ASSORTED PLASTIC ANCHOR KIT  
WAKTRIO**

*Three Of The Most Popular Style Anchors – Screws Included  
All In An E-Z To Store Plastic Case*

**3 Anchors in 1 Kit!**

**WAKTRIO KIT CONTAINS**

PART#	UPC#	QTY.	SIZE	ITEM	WT. PER PKG.
<b>WAKTRIO (300 pcs)</b>	38990	25	6 x1	Pan Combo Screw	.64
		25	3/16	Red Plastic Anchors	
		25	10 x1	Pan Combo Screw	
		25	1/4	Yellow Super Anchors	
		25	10 x1	Pan Combo Screw	
		25	1/4	Red Plastic Anchors	

**OTHER SIZES AND QUANTITIES AVAILABLE BY REQUEST**



**1/4" WALL ANCHOR KIT**

- 500 pcs. – #10 x 1" Pan Head Combo Tapping Screws
- 500 pcs. – 1/4" Red Anchors
- 5 – 1/4" x 4" Masonry Drill Bits

PART#	UPC#	ITEM	DIAMETER	LENGTH	WT. PER PKG	STD. PKG. UM
<b>WAK14V</b>	20218	Red Anchors	1/4	1	4.35	500
		Pan Hd Combo Screws	#10	1		500
		Masonry Drill	1/4	4		5



**RACEWAY ANCHOR KIT**

*Need to anchor your raceway?*

*This kit contains screws and anchors for mounting plastic or metal raceway to sheet-rock, wood, metal or masonry walls.*



PART#	UPC#	DESCRIPTION	WT. PER PKG.
<b>RWAK1 (177 pcs)</b>	20350	(40) 3/16 Plastic Anchors	.74
		(20) 1/4 Plastic Anchors	
		(15) Self Drilling Plastic Anchors	
		(40) #6 x 1 Flat Head Phillips Sheet Metal Screws	
		(20) #8 x 1 1/2 Flat Head Phillips Sheet Metal Screws	
		(20) #10 x 1 Flat Head Phillips Sheet Metal Screws	
		(1) 3/16 x 4 Masonry Drill	
		(1) 1/4 x 4 Masonry Drill	







**"BIG RED"**  
**CONICAL PLASTIC**  
**WALL ANCHOR KITS**  
 NOW WITH QUADRIVE OPTION!



**MASTER**  
**CARTONS**  
**CONTAIN:**  
**25 KITS**  
**18 JARS**

PART#	UPC#	SIZE	QTY	SIZE	ITEM	WT. PER PKG.	STD. PKG. UM
<b>WAK13</b> <b>WAKJ13</b>	20200/kit 20570/jar	3/16	100	3/16	Red Plastic Anchors	.48	1/25
			100	6 x1	Pan Combo Screws	.49	1/18
			1	3/16	Masonry Drill		
<b>WAK2</b> <b>WAKJ2</b>	20245	3/16	100	3/16	Red Plastic Anchors	.54	1/25
			100	8 x 3/4	Pan Combo Screws		1/18
			1	3/16	Masonry Drill		
<b>WAK16</b> <b>WAKJ16</b>	20280/kit 20281/jar	3/16	100	3/16	Red Plastic Anchors	.73	1/25
			100	8 x1	Pan Combo Screws	.68	1/18
			1	3/16	Masonry Drill		
<b>WAK16T</b> <b>WAKJ16T</b>	20284/kit 20285/jar	3/16	100	3/16	Red Plastic Anchors	.65	1/25
			100	8 x1	Pan Tri-Drive 	.69	1/18
			1	3/16	Masonry Drill		
<b>WAK16H</b> <b>WAKJ16H</b>	20288/kit 20289/jar	3/16	100	3/16	Red Plastic Anchors	.75	1/25
			100	8 x1	Hex Slotted Screws 1/4 Head	.70	1/18
			1	3/16	Masonry Drill		
<b>WAK16R</b> <b>WAKJ16R</b>	20292/kit 20293/jar	3/16	100	3/16	Red Plastic Anchors	.76	1/25
			100	8 x1	Pan Square Drive Screws	.76	1/18
			1	3/16	Masonry Drill		
<b>WAK16QD</b> <b>WAKJ16QD</b>	38980/kit 38981/jar	3/16	100	3/16	Red Plastic Anchors	.79	1/25
			100	8 x1	QuaDrive 1/4 	.70	1/18
			1	3/16	Masonry Drill		
<b>WAK14D</b> <b>WAKJ14D</b>	20208/kit 20760/jar	1/4	100	1/4	Red Plastic Anchors	1.06	1/25
			100	10x1	Hex Slotted Screws 5/16 Head		1/18
			1	1/4	Masonry Drill		
			1	5/16	Driver		
<b>WAK14</b> <b>WAKJ14</b>	20205/kit 20575/jar	1/4	100	1/4	Red Plastic Anchors	.89	1/25
			100	10 x1	Pan Combo Screws	.93	1/18
			1	1/4	Masonry Drill		
<b>WAK14T</b> <b>WAKJ14T</b>	20446/kit 20447/jar	1/4	100	1/4	Red Plastic Anchors	1.00	1/25
			100	10 x1	Pan Tri-Drive 	.93	1/18
			1	1/4	Masonry Drill, 000R2B Bit		
<b>WAK14H</b> <b>WAKJ14H</b>	20207/kit 20580/jar	1/4	100	1/4	Red Plastic Anchors	1.00	1/25
			100	10 x1	Hex Slotted Screws 5/16 Head	.93	1/18
			1	1/4	Masonry Drill		
<b>WAK14Q</b> <b>WAKJ14Q</b>	20206/kit 20583/jar	1/4	100	1/4	Red Plastic Anchors	.79	1/25
			100	10 x1	Hex Slotted Screws 1/4 Head	.83	1/18
			1	1/4	Masonry Drill		
<b>WAK14R</b> <b>WAKJ14R</b>	20445/kit 20590/jar	1/4	100	1/4	Red Plastic Anchors	.95	1/25
			100	10 x1	Pan Combo Screws	.93	1/18
			1	1/4	Masonry Drill		

OTHER SIZES AND QUANTITIES AVAILABLE BY REQUEST



CONTINUED  
**"BIG RED"**  
**CONICAL PLASTIC  
 WALL ANCHOR KITS**  
 NOW WITH QUADRIVE OPTION!



**MASTER  
 CARTONS  
 CONTAIN:**  
**25 KITS  
 18 JARS**

PART#	UPC#	SIZE	QTY	SIZE	ITEM		WT. PER PKG.	STD. PKG. UM	
<b>WAK14SS</b>	99414/kit	1/4	100	1/4	Red Plastic Anchors		.96	1/25	
<b>WAKJ14SS</b>	99420/jar		100	10 x1	Pan Slotted Screws S.S.			.94	1/18
			1	1/4	Masonry Drill				
<b>WAK14HSS</b>	99415/kit	1/4	100	1/4	Red Plastic Anchors		1.04	1/25	
<b>WAKJ14HSS</b>	99419/jar		100	10 x1	5/16 Hex Slotted Screws S.S.			1.02	1/18
			1	1/4	Masonry Drill				
<b>WAK14QD</b>	39160/kit	1/4	100	1/4	Red Plastic Anchors		1.07	1/25	
<b>WAKJ14QD</b>	39161/jar		100	10 x1	QuaDrive 5/16			1.03	1/18
			1	1/4	Masonry Drill				
<b>WAK14SSPH</b>	99418/kit	5/16	100	1/4	Red Plastic Anchors		.96	1/25	
<b>WAKJ14SSPH</b>	99417/jar		100	10 x1	Pan Phillips Screws S.S.			.96	1/18
			1	1/4	Masonry Drill				
<b>WAK141</b>	23841/kit	1/4	100	1/4	Red Plastic Anchors		1.00	1/25	
<b>WAKJ141</b>	20584/jar		100	10 x1 1/4	Pan Combo Screws			1.00	1/18
			1	1/4	Masonry Drill				
<b>WAK141H</b>	20588/kit	1/4	100	1/4	Red Plastic Anchors		1.02	1/25	
<b>WAKJ141H</b>			100	10 x1 1/4	Hex Washer Head Screws				1/18
			1	1/4	Masonry Drill				
<b>WAK14QD145</b>	39174	1/4	100	1/4	Red Plastic Anchors		1.10	1/25	
<b>WAKJ14QD145</b>			100	10 x1 1/4	QuaDrive 5/16				1/18
			1	1/4	Masonry Drill				
<b>WAK15R</b>	20450/kit	5/16	50	5/16	Red Plastic Anchors		1.00	1/25	
<b>WAKJ15R</b>	20615/jar		50	12 x1 1/4	Pan Square Drive Screws			.74	1/18
			1	5/16	Masonry Drill				
<b>WAK15D</b>	20416/kit	5/16	50	1/4	Red Plastic Anchors		.81	1/25	
<b>WAKJ15D</b>			50	12 x1 1/4	5/16 Hex Slot Screw				1/18
			1	1/4	Masonry Driver				
			1	5/16	Hex Driver				
<b>WAK15S</b>	39162/kit	1/4	50	1/4	Red Plastic Anchors		.88	1/25	
<b>WAKJ15S</b>	39163/jar		50	12 x1 1/4	Ind. Hex Slotted Screw			.81	1/18
			1	1/4	Masonry Drill				
<b>WAK15QD</b>	39164/kit	1/4	100	1/4	Red Plastic Anchors		.83	1/25	
<b>WAKJ15QD</b>	39165/jar		100	12 x1 1/4	QuaDrive 5/16			.77	1/18
			1	1/4	Masonry Drill				
<b>WAK1415H</b>	20497/kit	5/16	50	5/16	Red Plastic Anchors		1.02	1/25	
<b>WAKJ1415H</b>			50	14 x1 1/2	Hex Washer Head Screws				1/18
			1	5/16	Masonry Drill				
<b>WAK15</b>	20210/kit	5/16	50	5/16	Red Plastic Anchors		1.05	1/25	
<b>WAKJ15</b>	20605/jar		50	1/4 x1 1/2	Pan Combo Screws			.80	1/18
			1	5/16	Masonry Drill				

OTHER SIZES AND QUANTITIES AVAILABLE BY REQUEST



## "DENVER BLUE" CONICAL PLASTIC WALL ANCHOR KITS

NOW WITH QUADRIVE OPTION!

MASTER  
CARTONS  
CONTAIN:  
25 KITS  
18 JARS

*In some areas of the country, tradesmen prefer blue to red. Same Product - Different Color*

PART#	UPC#	SIZE	QTY.	SIZE	ITEM		WT. PER PKG.	STD. PKG. UM	
<b>WAK13B</b>	20201/kit	3/16	100	3/16	Blue Plastic Anchors		.53	1/25	
<b>WAKJ13B</b>	20571/jar		100	6 x1	Pan Square Drive Screws			.54	1/18
			1	3/16	Masonry Drill				
<b>WAK13BV</b>	20371/kit	3/16	500	3/16	Blue Plastic Anchors		2.21	1/25	
			500	6 x1	Pan Combo Screws				1/18
			1	3/16	Masonry Drill				
<b>WAK16B</b>	20315/kit	3/16	100	3/16	Blue Plastic Anchors		.75	1/25	
<b>WAKJ16B</b>			100	8 x1	Pan Combo Screws				1/18
			1	3/16	Masonry Drill				
<b>WAK14B</b>	20209/kit	1/4	100	1/4	Blue Plastic Anchors		.89	1/25	
<b>WAKJ14B</b>	20576/jar		100	10 x1	Pan Combo Screws				1/18
			1	1/4	Masonry Drill				
<b>WAK14TB</b>	20204/kit	1/4	100	1/4	Blue Plastic Anchors		1.01	1/25	
<b>WAKJ14TB</b>	20577/jar		100	10 x1	Pan Tri-Drive 				1/18
			1	1/4	Masonry Drill, 000R2B Bit				
<b>WAK14HB</b>	20213/kit	1/4	100	1/4	Blue Plastic Anchors		1.01	1/25	
<b>WAKJ14HB</b>	20578/jar		100	10 x1	5/16 Hex Slotted Screws				1/18
			1	1/4	Masonry Drill				
<b>WAK14QB</b>	20216/kit	1/4	100	1/4	Blue Plastic Anchors		.88	1/25	
<b>WAKJ14QB</b>	20581/jar		100	10 x1	1/4 Hex Slotted Screws				1/18
			1	1/4	Masonry Drill				
<b>WAK14HBSS</b>	20814/kit	1/4	100	1/4	Blue Plastic Anchors		1.00	1/25	
<b>WAKJ14HBSS</b>	99416/jar		100	10 x1	1/4 Hex Slotted Screws S.S.				1/18
			1	1/4	Masonry Drill				
<b>WAK14RB</b>	20217/kit	1/4	100	1/4	Blue Plastic Anchors		1.03	1/25	
<b>WAKJ14RB</b>	20582/jar		100	10 x1	Pan Square Drive Screws				1/18
			1	1/4	Masonry Drill				
<b>WAK14QDB</b>	39166/kit	1/4	100	1/4	Blue Plastic Anchors		1.07	1/25	
<b>WAKJ14QDB</b>	39167/jar		100	10 x1	QuaDrive 5/16 				1/18
			1	1/4	Masonry Drill				
<b>WAK1425QDB</b>	19987/kit	1/4	100	1/4	Blue Plastic Anchors		1.12	1/25	
<b>WAKJ1425QDB</b>			100	10 x1	QuaDrive 5/16 				1/18
				1	1/4				Masonry Drill
<b>WAK19B</b>	53350/kit	1/4	100	1/4	Blue Plastic Anchors		.93	1/25	
<b>WAKJ19B</b>	53349/kit		100	10 x1	Pan Combo Screws				1/18
			1	1/4	Masonry Drill				
<b>WAK141B</b>	20585/kit	1/4	100	1/4	Blue Plastic Anchors		1.00	1/25	
<b>WAKJ141B</b>	20586/jar		100	10 x1 1/4	Pan Square Drive Screws				1/18
			1	1/4	Masonry Drill				
<b>WAK141QDB</b>	39188/kit	1/4	100	1/4	Blue Plastic Anchor		1.13	1/25	
<b>WAKJ141QDB</b>	39189/jar		100	10 x1 1/4	QuaDrive 5/16 				1/18
			1	1/4	Masonry Drill				
<b>WAK14DB</b>	20214/kit	1/4	100	1/4	Blue Plastic Anchors		1.06	1/25	
<b>WAKJ14DB</b>	20579/jar		100	10 x1 5/16	Hex Head Slotted Screws				1/18
			1	1/4	Masonry Drill				
			1	5/16	Driver				
<b>WAK15SB</b>	20417/kit	1/4	50	1/4	Blue Plastic Anchors		.85	1/25	
<b>WAKJ15SB</b>	39169/jar		50	12 x1 1/4	Hex Slotted Screw				1/18
			1	1/4	Masonry Drill				

OTHER SIZES AND QUANTITIES AVAILABLE BY REQUEST

CONTINUED ON NEXT PAGE  
[www.metallics.us](http://www.metallics.us)



CONTINUED

## "DENVER BLUE" CONICAL PLASTIC WALL ANCHOR KITS

MASTER  
CARTONS  
CONTAIN:  
25 KITS  
18 JARS



NOW WITH QUADRIVE OPTION!

In some areas of the country, tradesmen prefer blue to red. Same Product - Different Color

PART#	UPC#	SIZE	QTY.	SIZE	ITEM	WT. PER PKG.	STD. PKG. UM
WAK15CB WAKJ15CB	391915/kit 39191/jar	1/4	50	1/4	Blue Plastic Anchors		1/25
			50	12 x 1 1/4	Pan Combo Screws		
			1	1/4	Masonry Drill		
WAK15QDB WAKJ15QDB	39170/kit 39171/jar	1/4	100	1/4	Blue Plastic Anchors		1/25
			100	12 x 1 1/4	QuaDrive 5/16		
			1	1/4	Masonry Drill		
WAK15RB WAKJ15RB	20212/kit 20607/jar	5/16	50	5/16	Blue Plastic Anchors		1/25
			50	12 x 1 1/4	Pan Square Drive Screws		
			1	5/16	Masonry Drill		
WAK15114HB WAKJ15114HB	39197/kit 39173/jar	5/16	50	1/4	Blue Plastic Anchors		1/25
			50	14 x 1 1/4	3/8 Hex Head Slot		
			1	5/16	Masonry Drill		
WAK15B WAKJ15B	20211/kit 20606/jar	5/16	50	5/16	Blue Plastic Anchors		1/25
			50	1/4 x 1 1/2	Pan Combo Screws		
			1	5/16	Masonry Drill		

OTHER SIZES AND QUANTITIES AVAILABLE BY REQUEST



## "SUPER YELLOW" PLASTIC WALL ANCHOR KITS

MASTER  
CARTONS  
CONTAIN:  
25 KITS  
18 JARS

PART#	UPC#	SIZE	QTY.	SIZE	ITEM	WT. PER PKG.	STD. PKG. UM
WAK18 WAKJ18	20255/kit 20645/jar	3/16	100	3/16	Super Yellow Plastic Anchors		1/25
			100	6 x 1	Pan Square Drive Screws		
			1	3/16	Masonry Drill		
WAK18T WAKJ18T	20256/kit 20640/jar	3/16	100	3/16	Super Yellow Plastic Anchors		1/25
			100	6 x 1	Pan Combo Screws		
			1	3/16	Masonry Drill		
WAK19 WAKJ19	20260/kit 20650/jar	1/4	100	1/4	Super Yellow Plastic Anchors		1/25
			100	10 x 1	Pan Combo Screws		
			1	1/4	Masonry Drill, 000R2B Bit		
WAK19T WAKJ19T	20261/kit 20651/jar	1/4	100	1/4	Super Yellow Plastic Anchors		1/25
			100	10 x 1	Pan Tri-Drive		
			1	1/4	Masonry Drill		
WAK19H WAKJ19H	21575/kit 20655/jar	1/4	100	1/4	Super Yellow Plastic Anchors		1/25
			100	10 x 1	Hex Slotted Screws 5/16 Head		
			1	1/4	Masonry Drill		
WAK19S WAKJ19S	20262/kit 20670/jar	1/4	100	1/4	Super Yellow Plastic Anchors		1/25
			100	10 x 1 1/4	Hex Slotted Screws 5/16 Head		
			1	1/4	Masonry Drill		
WAK19SS WAKJ19SS	20263/kit 99470/jar	1/4	100	1/4	Super Yellow Plastic Anchors		1/25
			100	10 x 1 1/2	Pan Phillips Screws S.S.		
			1	1/4	Masonry Drill		
WAK20 WAKJ20	20265/kit 20680/jar	5/16	50	5/16	Super Yellow Plastic Anchors		1/25
			50	12 x 1 1/4	Pan Combo Screws		
			1	5/16	Masonry Drill		

OTHER SIZES AND QUANTITIES AVAILABLE BY REQUEST

CONTINUED ON NEXT PAGE

www.metallics.us



CONTINUED



## "SUPER YELLOW" PLASTIC WALL ANCHOR KITS

MASTER  
CARTONS  
CONTAIN:  
25 KITS  
18 JARS

PART#	UPC#	SIZE	QTY.	SIZE	ITEM	WT. PER PKG.	STD. PKG. UM	
WAK191S	32192/kit	5/16	100	5/16	Super Yellow Plastic Anchors		1/25	
WAKJ191S	20673/jar		100	12 x 1 1/2	Hex Slotted Screws 5/16 Head		1.01	1/18
			1	5/16	Masonry Drill		1.05	
<b>SUPER YELLOW QUADRIVE</b>								
WAK19QD	39176/kit	1/4	100	1/4	Super Yellow Plastic Anchors		1/25	
WAKJ19QD	39177/jar		100	10 x 1	QuaDrive 5/16		1.07	1/18
			1	1/4	Masonry Drill		1.00	
WAK1925QD	39194/kit	1/4	100	1/4	Super Yellow Plastic Anchors		1/25	
WAKJ1925QD	20594/jar		100	10 x 1 1/4	QuaDrive 5/16		1.07	1/18
			1	1/4	Masonry Drill			

OTHER SIZES AND QUANTITIES AVAILABLE BY REQUEST



## "WHITE" PLASTIC WALL ANCHOR KITS

MASTER  
CARTONS  
CONTAIN:  
25 KITS  
18 JARS

PART#	UPC#	SIZE	QTY.	SIZE	ITEM	WT. PER PKG.	STD. PKG. UM	
WAK7	20230/kit	3/16	100	3/16	Vinyl Anchors		1/25	
WAKJ7	20500/jar		100	6 x 1	Pan Combo Screws		.75	1/18
			1	3/16	Masonry Drill		.75	

OTHER SIZES AND QUANTITIES AVAILABLE BY REQUEST



## COLLARLESS VINYL WALL ANCHOR KITS

MASTER  
CARTONS  
CONTAIN:  
25 KITS  
18 JARS

PART#	UPC#	SIZE	QTY.	SIZE	ITEM	WT. PER PKG.	STD. PKG. UM	
WAK8	20235/kit	1/4	100	1/4	Green Collarless Vinyl Anchor		1/25	
WAKJ8	20505/jar		100	10 x 1	Pan Combo Screws		.97	1/18
			1	1/4	Masonry Drill			
WAK8T	20402/kit	1/4	100	1/4	Green Collarless Vinyl Anchor		1/25	
WAKJ8T	20640/jar		100	10 x 1	Pan Tri-Drive		1.07	1/18
			1	1/4	Masonry Drill, 000R2B Bit		.80	
WAK8QD	39180/kit	1/4	100	1/4	Green Collarless Vinyl Anchor		1/25	
WAKJ8QD	39181/jar		100	10 x 1	QuaDrive 5/16		1.00	1/18
			1	1/4	Masonry Drill		1.00	
WAK9	20240/kit	5/16	50	5/16	Blue Collarless Vinyl Anchor		1/25	
WAKJ9	20510/jar		50	12 x 1 1/4	Pan Combo Screws		.86	1/18
			1	5/16	Masonry Drill		.78	

OTHER SIZES AND QUANTITIES AVAILABLE BY REQUEST



## GRAY CONICAL PLASTIC WALL ANCHOR KITS

NOW WITH QUADRIVE OPTION!

MASTER CARTONS CONTAIN:  
25 KITS  
18 JARS

PART#	UPC#	SIZE	QTY.	SIZE	ITEM	WT. PER PKG.	STD. PKG. UM	
<b>WAK22</b>	10500/kit	3/16	100	3/16	Gray Ribbed Anchors		1/25	
<b>WAKJ22</b>	20730/jar		100	6 x 1	Pan Combo Screws		.55	1/18
			1	3/16	Masonry Drill		.50	
<b>WAK25</b>	20410/kit	3/16	100	3/16	Gray Ribbed Anchors		1/25	
<b>WAKJ25</b>	20751/jar		100	8 x 1	Pan Combo Screws		.57	1/18
			1	3/16	Masonry Drill		.57	
<b>WAK23</b>	20400/kit	1/4	100	1/4	Gray Ribbed Anchors		1/25	
<b>WAKJ23</b>	20740/jar		100	10 x 1	Pan Combo Screws		.80	1/18
			1	1/4	Masonry Drill, 000R2B Bit		.91	

### ANCHOR KIT DESIGNED FOR RACEWAY

<b>WAK23F</b>	39182/kit	1/4	100	1/4	Gray Ribbed Anchors		.80	1/25
<b>WAKJ23F</b>	20745/jar		100	10 x 1	Flat Head Phillips Screws		.80	1/18
			1	1/4	Masonry Drill			
<b>WAK23T</b>	20401/kit	1/4	100	1/4	Gray Ribbed Anchors		.80	1/25
<b>WAKJ23T</b>	20767/jar		100	10 x 1	Pan Tri-Drive		.80	1/18
			1	1/4	Masonry Drill			
<b>WAK23QD</b>	39184/kit	1/4	100	1/4	Gray Ribbed Anchors		.80	1/25
<b>WAKJ23QD</b>	39185/jar		100	10 x 1	QuaDrive 5/16		.80	1/18
			1	1/4	Masonry Drill			
<b>WAK24</b>	20405/kit	5/16	50	5/16	Gray Ribbed Anchors		.85	1/25
<b>WAKJ24</b>	20750/jar		50	12 x 1 1/4	Pan Combo Screws		.77	1/18
			1	5/16	Masonry Drill			

OTHER SIZES AND QUANTITIES AVAILABLE BY REQUEST



## EXPANDET LIGHT ROSETT NYLON WALL ANCHOR KITS

MASTER CARTONS CONTAIN:  
25 KITS  
18 JARS

PART#	UPC#	SIZE	QTY.	SIZE	ITEM	WT. PER PKG.	STD. PKG. UM	
<b>WAK33</b>	20270/kit	1/4	50	1/4	Expandet Nylon Anchors		1/25	
<b>WAKJ33</b>	22229/jar		50	8 x 2	Pan Combo Screws		.70	1/18
			1	1/4	Masonry Drill		.66	
<b>WAK33R</b>	20272/kit	1/4	50	1/4	Expandet Nylon Anchors		1/25	
<b>WAKJ33R</b>	20761/jar		50	8 x 2	Square Drive Screws		.80	1/18
			1	1/4	Masonry Drill		.65	
<b>WAK34</b>	20271/kit	5/16	25	5/16	Expandet Nylon Anchors		1/25	
<b>WAKJ34</b>	22240/jar		25	12 x 2	Pan Combo Screws		.65	1/18
			1	5/16	Masonry Drill, 000R2B Bit		1.00	

OTHER SIZES AND QUANTITIES AVAILABLE BY REQUEST



## 4 Anchors in 1 Kit! QUAD PLASTIC ANCHOR KIT

- Four Different Style Anchors
- Screws And Driver Bit Included
- Drill Bits Included
- One Four Compartment Plastic Case

PART#	UPC#	SIZE	QTY.	ITEM	WT. PER PKG.	STD. PKG. UM
WAKQUAD (165 pcs)	38995	$\frac{3}{16}$	20	Super Yellow Plastic Anchors	1.08	1/25
		8 x 1	20	Pan Head Combo Sheet Metal Screw		
		$\frac{3}{16}$ x 4	1	High Speed Drill Bit		
		$\frac{1}{4}$	20	Big Red Plastic Anchors		
		10 x 1	20	Pan Head Combo Sheet Metal Screw		
		$\frac{1}{4}$ x 4	1	High Speed Drill Bit		
		$\frac{1}{4}$	20	Super Yellow Plastic Anchor		
		10 x 1	20	Pan Head Combo Sheet Metal Screw		
		$\frac{1}{4}$ x 4	1	High Speed Drill Bit		
		$\frac{5}{16}$	20	Denver Blue Plastic Anchors		
		12 x 1 $\frac{1}{4}$	20	Pan Head Combo Sheet Metal Screw		
$\frac{5}{16}$ x 4 $\frac{1}{2}$	1	High Speed Drill Bit				
2	1	#2 Phillips Power Bit				

OTHER SIZES AND QUANTITIES AVAILABLE BY REQUEST



## MULTI NYLON PLUG FOR HOLLOW WALL APPLICATIONS.

### Pre installation or through fixing

Automatic collar detachment makes the plug multifunctional.

### Knock-in protection

Prevents premature expansion while installing.

### Self tensioning

stops the plug rotating in the drill hole.

PART#	UPC#	DIAMETER	LENGTH	SCREW SIZE	DRILL BIT SIZE	WT. PER PKG.	QTY.	STD. PKG. UM
MAU8	60813	$\frac{1}{4}$	1 $\frac{3}{8}$	#8	$\frac{1}{4}$	.45	100	1
MAU81	60812	$\frac{1}{4}$	1 $\frac{3}{4}$	#8	$\frac{1}{4}$	.49	100	1
MAU10	60814	$\frac{5}{16}$	2	#10	$\frac{5}{16}$	.72	100	1
MAU14	60815	$\frac{3}{8}$	2 $\frac{3}{8}$	#14	$\frac{3}{8}$	.70	50	1
MAU516	60816	$\frac{1}{2}$	2 $\frac{3}{4}$	$\frac{5}{16}$	$\frac{1}{2}$	.98	50	1
MAU38	60817	$\frac{9}{16}$	3	$\frac{3}{8}$	$\frac{9}{16}$	.80	25	1

OTHER SIZES AND QUANTITIES AVAILABLE BY REQUEST



## QUATTRO® NYLON PLUG FOR USE IN ALL KINDS OF BUILDING MATERIALS.

### Rotation resistance

stops the plug rotating in the drill hole.

### Knock-in protection

Prevents premature expansion while installing.

### Reduced installation time

Special plug geometry allows ease of entry into the drill hole.

PART#	UPC#	DIAMETER	LENGTH	SCREW SIZE	DRILL BIT SIZE	WT. PER PKG.	QTY.	STD. PKG. UM
MAQ316	60818	$\frac{3}{16}$	1	#8	$\frac{3}{16}$	.41	100	1
MAQ81	60819	$\frac{1}{4}$	1 $\frac{3}{16}$	#8	$\frac{1}{4}$	.41	100	1
MAQ10	60820	$\frac{5}{16}$	1 $\frac{9}{16}$	#10	$\frac{5}{16}$	.63	100	1
MAQ14	60821	$\frac{3}{8}$	2	#14	$\frac{3}{8}$	.61	50	1
MAQ516	60822	$\frac{1}{2}$	2 $\frac{3}{8}$	$\frac{5}{16}$	$\frac{1}{2}$	.57	25	1
MAQ38	60823	$\frac{9}{16}$	2 $\frac{3}{4}$	$\frac{3}{8}$	$\frac{9}{16}$	.80	25	1

OTHER SIZES AND QUANTITIES AVAILABLE BY REQUEST



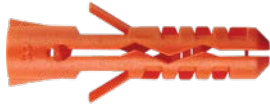

## NYLON PLUG FOR SOLID BASE MATERIALS.

**Knock-in protection**  
Prevents premature expansion while installing

**Stabilization points**  
Prevent the plug from breaking open while inserting into the hole.

**M-Teeth**  
Ensuring a complete radial expansion during screw insertion.

**Block profile and tapered end**  
Holds the plug firm in the hole against rotation; guarantees immediate grip as the plug expands.

PART#	UPC#	DIAMETER	LENGTH	SCREW SIZE	DRILL BIT SIZE	WT. PER PKG.	QTY.	STD. PKG. UM
MAN8	60827	3/16	1	#8	3/16	.32	100	1
MAN81	60828	1/4	1 3/16	#8	1/4	.36	100	1
MAN101	60830	5/16	1 9/16	#10	5/16	.54	100	1
MAN14	60831	3/8	2	#14	3/8	.52	50	1
MAN14M	60844	3/8	2	#14	3/8	.52	1000	1
MAN516	60832	1/2	2 3/8	5/16	1/2	.73	50	1
MAN38	60833	9/16	2 3/4	3/8	9/16	.64	25	1
MAN1680	60846	16mm	80mm	12-14	5/8	.79	100	1

OTHER SIZES AND QUANTITIES AVAILABLE BY REQUEST

## EASY-FIX



For use with aerated concrete and other soft building materials. Soft board (wooden fibre boards), Particleboard, Gypsum, XPS thermal insulation and more.

- No pre-drilling in aerated concrete. In other building materials it's recommended to use the same diameter of drill as the diameter of the plug.
- For use with wood, self-tapping, sheet metal screws and hexagon screws
- Pre installation
- Indoor applications

PART#	UPC#	SIZE	SCREW SIZE	DRILL BIT SIZE	WT. PER PKG.	STD. PKG. UM
MEF632	60849	1/4" x 1 1/4"	10-14	1/4	.52	50
MEF838	60850	5/16" x 1 1/2"	14-3/8"	5/16	.98	50
MEF860	60851	5/16" x 2 3/8"	14-3/8"	5/16	1.38	50
MEF1060	60852	3/8" x 2 3/8"	5/16" - 1/2"	3/8	1.63	50



## SELF-DRILLING WALL ANCHORS ZINC

For single, double drywall, plasterboard and gypsum fibre board  
Combo drive #2 Phillips



PART#	UPC#	SCREW SIZE	SIZE	WT. PER PKG.	QTY.	STD. PKG. UM
ZSTU1J/jar	81315	#8	1 1/2	1.15	50	1/18
ZSTU1K/kit	81319	#8	1 1/2	1.22	50	1/25
ZSTU1M/box	81323	#8	1 1/2	15.06	1000	1

OTHER SIZES AND QUANTITIES AVAILABLE BY REQUEST



## METAL JET PLUG WITH 1/4" - 20 EXTERNAL THREAD

For use with pipe clips and single plasterboard with reduced length for limited spacing behind drywall



PART#	UPC#	SIZE	SCREW SIZE	WT. PER PKG.	STD. PKG. UM
MJP1420	60839	1 1/2	1/4-20	2.24	100/500
MJPMSQ	60838	SQ Bit For MJP1420		.05	1

## SELF-DRILLING WALL ANCHORS ZINC

For single, double drywall, plasterboard and gypsum fibre board  
Combo drive #2 Phillips



- Thin cutting thread; easy and reliable installation in drywall
- Pre installation
- Back twist lock permits the disassembly of screws without the movement of the plug
- Center point ensures an easy setting and drilling in the plate
- Indoor applications



PART#	UPC#	SCREW SIZE	SIZE	WT. EACH	QTY.	STD. PKG. UM
JZSA1/jar	80973	#8	1½	1.59	100	1
ZSA1M/box	33261	#8	1½	13.15	1000	1
ZSA1B/box	62157	#8	1½	19.63	1500	1

OTHER SIZES AND QUANTITIES AVAILABLE BY REQUEST



100P2B Included

- Thin cutting thread; easy and reliable installation in drywall
- Center point ensures an easy setting
- Back twist lock permits the disassembly of screws without the movement of the plug and drilling in the plate



PART#	UPC#	QTY.	SIZE	ITEM	WT. PER PKG.	STD. PKG. UM
ZSA1K/box	33265	50	#8	Zinc Screw Anchors	1.11	1/25
ZSA1J/jar	20710	50	#8 x 1½	Pan Head Combo Screws	1.12	1/18
ZSA1TK/box	33266	50	#8	Zinc Screw Anchors	1.08	1/25
ZSA1TJ/jar	20269	50	#8 x 1½	Pan Head TriDrive Screws	1.07	1/18
		1	-	100P2B Bit		

OTHER SIZES AND QUANTITIES AVAILABLE BY REQUEST

## SELF-DRILLING WALL ANCHORS ZINC-LITE

For single drywall, plasterboard and with reduced length for limited spacing behind the drywall  
Combo drive #2 phillips • Uses #8 sheet metal or #8 drywall screws



- Thin cutting thread; easy and reliable installation in drywall
- Pre installation
- Back twist lock permits the disassembly of screws without the movement of the plug
- Center point ensures an easy setting and drilling in the plate
- Indoor applications

PART#	UPC#	QTY.	SCREW SIZE	SIZE	ITEM	WT. PER PKG.	STD. PKG. UM
JZSAL2	80974	100	#8	1	Zinc Alloy Anchor Lite	.85	100

OTHER SIZES AND QUANTITIES AVAILABLE BY REQUEST



100P1B Included

- Thin cutting thread; easy and reliable installation in drywall
- Center point ensures an easy setting and drilling in the plate
- Back twist lock permits the disassembly of screws without the movement of the plug



### ANCHOR KITS IN BOX AND JAR

PART#	UPC#	QTY.	SCREW SIZE	SIZE	ITEM	WT. PER PKG.	STD. PKG. UM
ZSAL2K/box	33267	50	#8 x 1	-	Zinc Alloy Anchor Lite	.66	1/25
ZSAL2J/jar	33268	50	#8 x 1	-	Pan Head Combo Screws	.64	1/18

OTHER SIZES AND QUANTITIES AVAILABLE BY REQUEST



## SELF-DRILLING WALL ANCHORS POLYAMIDE

Works great in Drywall • Combo Drive #2 Phillips



- Glass-fibre reinforced
- Electrically insulated
- Thin cutting thread; easy and reliable installation in drywall
- For single and double plasterboards
- Back twist lock permits the disassembly of screws without the movement of the plug
- Center point ensures an easy setting and drilling in the plate
- Pre installation
- Indoor and outdoor applications

PART#	UPC#	QTY.	SCREW SIZE	SIZE	ITEM	WT. PER PKG.	STD. PKG. UM
JPSA1/jar	80975	100	#8	1¼	Polyamide Anchors	.51	100
PSA1M/box	19824	1000	#8	1¼	Polyamide Anchors	3.29	1000

OTHER SIZES AND QUANTITIES AVAILABLE BY REQUEST



100P2B Included

### ANCHOR KITS IN BOX AND JAR

PART#	UPC#	QTY.	SCREW SIZE	SIZE	ITEM	WT. PER PKG.	STD. PKG. UM
PSA1K/box	29495	50	#8	-	Polyamide Anchors	.57	1/25
PSA1J/jar	20705	50	8 x 1¼	-	Pan Head Combo Screws	.60	1/18

OTHER SIZES AND QUANTITIES AVAILABLE BY REQUEST



## SELF-DRILLING WALL ANCHORS POLYAMIDE-LITE

Works great in drywall with reduced length for limited spacing behind drywall  
Combo Drive #2 Phillips



- Glass-fibre reinforced
- Electrically insulated
- For single and double plasterboards
- Reduced length for limited spacing behind drywall
- Thin cutting thread; easy and reliable installation in drywall
- Back twist lock permits the disassembly of screws without the movement of the plug
- Center point ensures an easy setting and drilling in the plate
- Pre installation
- Indoor and outdoor applications

PART#	JAR UPC#	QTY.	SCREW SIZE	SIZE	ITEM	WT. PER PKG.	STD. PKG. UM
JPSAL2	80976	100	#6	1	Polyamide Anchor Lite	.23	100

OTHER SIZES AND QUANTITIES AVAILABLE BY REQUEST



100P1B Included

### ANCHOR KITS IN BOX AND JAR

PART#	JAR UPC#	QTY.	SCREW SIZE	SIZE	ITEM	WT. PER PKG.	STD. PKG. UM
PSAL2K/box	19827	50	#6	-	Polyamide Anchor Lite	.35	1/25
PSAL2J/jar	20700	50	#8 6 x 1	-	Pan Head Combo Screws	.33	1/18

OTHER SIZES AND QUANTITIES AVAILABLE BY REQUEST



## DRILL TYPE TOGGLE ANCHORS



PART#	UPC#	QTY.	DIAMETER	LENGTH	ITEM	WT. PER PKG.	STD. PKG. UM
JEZT1	80977	50	#10	-	Toggles	2.01	1
		50	10-24	2	Pan Head Combo Machine Screws Zinc Plated		

OTHER SIZES AND QUANTITIES AVAILABLE BY REQUEST



### ANCHOR KITS IN BOX AND JAR

PART#	UPC#	QTY.	DIAMETER	LENGTH	ITEM	WT. PER PKG.	STD. PKG. UM
EZT1K/box	33275	25	#10	-	Plastic Anchors	1.11	1/25
EZT1J/jar	20715	25	10-24	2	Pan Head Combo Machine Screws Zinc Plated	1.24	1/18

OTHER SIZES AND QUANTITIES AVAILABLE BY REQUEST



## STRAP-TOGGLE ANCHORS

ANCHOR STEEL ZINC

*Designed for use in plaster, wallboard, concrete block or hollow tile*

PART#	UPC#	SCREW SIZE	DRILL	QTY	WT. PER PKG.	STD. PKG. UM
NT31625	18513	10-24	1/2	25	.69	25
NT316	18501	10-24	1/2	50	1.38	50/250
NT316100	18517	10-24	1/2	100	2.76	100
NT1425	18514	1/4-20	1/2	25	.71	25
NT1425J JAR	18522	1/4-20	1/2	25	.71	25/125
NT14	18502	1/4-20	1/2	50	1.41	50
*NT14100K1	18503	1/4-20	1/2	100	7.10	100
NT14C	18504	1/4-20	1/2	100	4.09	100
NT3815J JAR	18523	3/8-16	1/2	15	5.86	15
NT3825	18515	3/8-16	1/2	25	1.47	25
NT38	18510	3/8-16	1/2	100	5.86	100
NT12	18511	1/2-13	1/2	25	1.19	25

OTHER SIZES AND QUANTITIES AVAILABLE BY REQUEST

\*WITH 100 SCREWS 1/4-20 X 3 ROUND HEAD MS STEEL ZINC JRM128

*Because a wide variety of screws work with this Toggle Anchor, Metallica has chosen not to offer them in a kit, but rather to allow the user to choose the screw that works best for each particular application. Please see Screw/Section A for a full listing of our machine screws.*

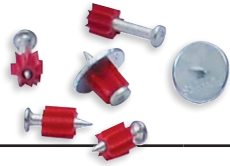

## .300 HEAD DRIVE PINS

Designed for permanently fastening a fixture to concrete, some types of masonry and A36 structural steel.

PART#	UPC#	DIAMETER	LENGTH	WT. PER PKG.	STD. PKG. UM
M50022	23612	.145	¾	.58	100
M50026	23613	.145	1	.72	100
M50032	13456	.145	1¼	.84	100
M50034	13457	.145	1½	.92	100
M50038	13458	.145	2	1.08	100
M50040	13459	.145	2¼	1.21	100
M50044	13460	.145	2½	1.29	100
M50048	13461	.145	3	1.70	100
<b>Knurled Shank</b>					
M50012	13453	.145	½	.45	100
M50016	13454	.145	5/8	.52	100
<b>BLACK SHANK</b>					
M50023	13455	.145	¾	.58	100
<b>WITH TOP HATS KNURLED SHANK</b>					
M50136	13469	.145	½	.48	100
M50138	13470	.145	5/8	.55	100
<b>WITH TOP HAT</b>					
M50140	13471	.145	¾	.61	100
<b>WITH ¾ WASHER</b>					
M50070	81918	.145	¾	1.50	100
M50080	13462	.145	2½	1.31	100
<b>WITH 7/8 WASHER</b>					
M50090	13463	.145	1	1.01	100
M50092	13464	.145	1¼	1.11	100
M50094	13465	.145	1½	1.19	100
M50096	13466	.145	2	1.29	100
M50098	13467	.145	2½	1.38	100
M50100	13468	.145	3	1.51	100

OTHER SIZES AND QUANTITIES AVAILABLE BY REQUEST



## .300 HEAD PINS WITH CEILING CLIPS

For acoustical applications and suspended ceiling systems or light fixtures.

PART#	UPC#	SHANK DIAMETER	SHANK LENGTH	WIRE HOLE	WT. PER PKG.	STD. PKG. UM
M50364	13477	.145	1	.278	3.50	100
M50368	13478	.145	1 1/8	.278	3.60	100
M50370	23656	.145	1¼	.278	3.70	100

OTHER SIZES AND QUANTITIES AVAILABLE BY REQUEST

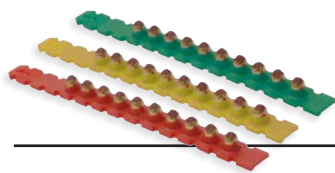

## POWDER LOADS

Single cartridge units for single shot tools and also collated in groups of 10 into plastic strips for semi-automatic tools.



PART#	UPC#	CALIBER	COLOR	WT. PER PKG.	STD. PKG. UM
M50500	13479	.22 A Loads	Gray	.28	100
M50502	13480	.22 A Brown Loads	Brown	.28	100
M50504	23642	.22 A Green Loads	Green	.28	100
M50506	23643	.22 A Yellow Loads	Yellow	.28	100
M50570	13481	.25 10 Load Strip	Green	.28	100
M50574	13482	.25 10 Load Strip	Yellow	.28	100
M50578	13483	.25 10 Load Strip	Red	.28	100
M50612	13484	.27 Long Loads	Red	.28	100
M50614	13485	.27 Long Loads	Purple	.28	100
M50620	13486	.27 Safety Strip Loads	Brown	.28	100
M50622	11513	.27 Safety Strip Loads	Green	.28	100
M50626	11508	.27 Safety Strip Loads	Yellow	.28	100
M50630	11511	.27 Safety Strip Loads	Red	.28	100



# FIXTURE HANGING ACCESSORIES



## HEX ROD COUPLINGS

STEEL ZINC • 18-8 STAINLESS • 316 STAINLESS • GALVANIZED

PART#	UPC#	ROD SIZE	HEX SIZE	LENGTH	WT. PER PKG.	STD. PKG. UM
<b>STEEL ZINC</b>						
RCT2	41351	8-32	¼	¾	1.16	100
RCT25	21700	10-24	¼	¾	1.44	100
RCT26	21705	¼-20	¾	7/8	1.02	50
RCTL26 (1¾ LONG)	23326	¼-20	¾	1¾	3.06	50
RCT27	21710	5/16-18	½	7/8	1.21	50
RCT28	21715	¾-16	½	1 1/8	1.87	50
RCTL28 (1¾ LONG)	23328	¾-16	½	1 1/8	5.71	50
RCT35	21701	¾-16	½	1¾	11.98	100
RCT28V	61028	¾-16	½	1 1/8	17.79	500
RCT28M	21718	¾-16	½	1 1/8	36.90	1000
RCT29	21720	½-13	11/16	1¼	1.46	25
RCTL29 (1¾ LONG)	23329	½-13	11/16	1¾	2.95	25
RCT29C	27182	½-13	11/16	1¼	5.90	100
RCT30	21725	5/8-11	13/16	2	2.24	25
RCT31	21728	¾-10	1	1¼	7.19	25
RCT33	21730	7/8-9	1¼	2¼	29.95	100
<b>18-8 STAINLESS</b>						
RCT26SS	10644	¼-20	¾	7/8	1.02	50
RCT27SS	10645	5/16-18	½	7/8	1.40	50
RCT28SS	21726	¾-16	½	1	1.87	50
RCT29SS	21727	½-13	11/16	1¼	1.52	25
RCT30SS	22830	5/8-11	13/16	1½	9.68	50
<b>316 STAINLESS</b>						
RCT28SS316	94828	¾-16	½	1	1.89	50
RCT29SS316	94829	½-13	11/16	1¼	2.85	50
RCT30SS316	94830	5/8-11	13/16	1½	4.48	50
<b>GALVANIZED</b>						
RCT26G	21719	¼-20	¾	7/8	2.85	50
RCT28G	21716	¾-16	½	1¾	3.15	50
RCT29G	21726	½-13	11/16	1¾	3.15	50
RCT30G	21717	5/8-11	13/16	2 1/8	4.24	25

OTHER SIZES AND QUANTITIES AVAILABLE BY REQUEST.



## REDUCING HEX ROD COUPLING

STEEL ZINC

PART#	UPC#	SIZE	WT. PER PKG.	STD. PKG. UM
RCTR28	21706	¾-16 to ¼-20	2.02	50
RCTR27	21704	¾-16 to 5/16-18	2.35	50
RCTR29	21707	½-13 to ¾-16	1.75	25
RCTR5812	21708	5/8-11 to ½-13	2.62	25

OTHER SIZES AND QUANTITIES AVAILABLE BY REQUEST.





## THREADED ROD

DOMESTIC • STEEL ZINC • 304 STAINLESS • 316 STAINLESS • GALVANIZED  
 Threaded Rod Sold Only In Full Bundle Quantities Where Listed.



PART#	UPC#	SIZE	WT. PER PKG.	STD. PKG. UM	TUBE QTY.
<b>DOMESTIC STEEL ZINC</b>					
TRS610D	21669	¼-20 x 10'	60.50	1	500 feet
TRS8/6D	21644	¾-16 x 6'	43.75	1	150 feet
TRS810A	21669	¾-16 x 10'	72.75	1	250 feet
TRS9/6BD	21652	½-13 x 6'	38.76	1	72 feet
<b>STEEL ZINC</b>					
TRS4/6	90357	8-32 x 6'	1.6	1	30 feet
TRS5/3	21612	10-24 x 3'	5.20	1	75 feet
TRS6/3	21613	¼-20 x 3'	18.00	1	150 feet
TRS6/113	21641	¼-20 x 4'	24.00	1	2000 feet
TRS6/6B	21640	¼-20 x 6'	36.50	1	300 feet
TRS610	21606	¼-20 x 10'	60.50	1	500 feet
TRS7/3	21614	5/16-18 x 3'	20.65	1	105 feet
TRS7/6	21610	5/16-18 x 6'	42.00	1	210 feet
TRS710	21604	5/16-18 x 10'	68.95	1	350 feet
TRS87	21647	¾-16 x 7"	.17	1	7"
TRS8/3	21617	¾-16 x 3'	21.50	1	75 feet
TRS8/6B	21645	¾-16 x 6'	43.75	1	150 feet
TRS810	21616	¾-16 x 10'	72.75	1	250 feet
TRS812	11549	¾-16 x 12'	42.00	1	144 feet
TRS9/3	21618	½-13 x 3'	31.40	1	60 feet
TRS9/6B	21650	½-13 x 6'	38.76	1	72 feet
TRS910	21621	½-13 x 10'	65.04	1	120 feet
TRS912	21694	½-13 x 12'	76.32	1	144 feet
TRS106	21607	5/8-11 x 6'	30.00	1	48 feet
TRS1010	21685	5/8-11 x 10'	67.04	1	80 feet
TRS1012	21695	5/8-11 x 12'	80.56	1	96 feet
TRS11-6	21580	¾-10 x 6'	37.50	1	30 feet
TRS1110	21690	¾-10 x 10'	47.90	1	50 feet
TRS1112	21691	¾-10 x 12'	74.84	1	60 feet
TRS1210	21624	7/8-9 x 10'	68.20	1	40 feet
TRS1310	21634	1-8 x 10'	22.31	1	30 feet
TRS1410	21635	1¼-7 x 10'	35.00	1	10 feet
TRS1510	21636	1½-6 x 10'	51.00	1	10 feet
<b>304 STAINLESS</b>					
TRS6/3SS	90631	¼-20 x 3'	.59	1	3 feet
TRS6/6SS	10619	¼-20 x 6'	.75	1	6 feet
TRS612SS	21693	¼-20 x 12'	3.00	1	12 feet
TRS7/3SS	21664	5/16-18 x 3'	.59	1	3 feet
TRS7/6SS	10618	5/16-18 x 6'	1.20	1	6 feet
TRS8/6SS	10616	¾-16 x 6'	1.80	1	6 feet
TRS812SS	11550	¾-16 x 12'	3.60	1	12 feet
TRS5/6SS	90538	7/16-14 x 6'	.75	1	6 feet
TRS9/6SS	10617	½-13 x 6'	3.18	1	6 feet
TRS912SS	21692	½-13 x 12'	6.36	1	12 feet
TRS106SS	21677	5/8-11 x 6'	5.00	1	6 feet
TRS11/6SS	90366	¾-10 x 6'	7.50	1	6 feet
TRS133SS	15573	1-8 x 3'	6.63	1	3 feet
<b>316 STAINLESS</b>					
TRS8/6-316	21646	¾-16 x 6'	1.75	1	6 feet
TRS9/6-316	10680	½-13 x 6'	3.18	1	6 feet

OTHER SIZES AND QUANTITIES AVAILABLE BY REQUEST. DOMESTIC ROD AVAILABLE BY REQUEST.





# FIXTURE HANGING ACCESSORIES

CONTINUED

## THREADED ROD

DOMESTIC • STEEL ZINC • 304 STAINLESS • 316 STAINLESS • GALVANIZED

Threaded Rod Sold Only In Full Bundle Quantities Where Listed.



PART#	UPC#	SIZE	WT. PER PKG.	STD. PKG. UM	TUBE QTY.
<b>GALVANIZED</b>					
TRS8/6HDG	21643	3/8-16 x 6'	43.75	1	150 feet
TRS810HDG	21649	3/8-16 x 10'	72.75	1	250 feet
TRS9/6HDG	21651	1/2-13 x 6'	81.25	1	150 feet
TRS910G	21622	1/2-13 x 10'	63.96	1	120 feet
TRS106G	21676	5/8-11 x 6'	30.00	1	48 feet
<b>PLAIN</b>					
TRS6/6PL	21642	1/4-20 x 6'	.73	1	300 feet
TRS910PL	21625	1/2-13 x 10'	5.33	1	120 feet
<b>BLACK OXIDE</b>					
TRS8-6BLK	22881	3/8-16 x 6'	1.72	1	150 feet
TRS106BLK	21687	5/8 x 6'	30.00	1	48 feet

OTHER SIZES AND QUANTITIES AVAILABLE BY REQUEST. DOMESTIC ROD AVAILABLE BY REQUEST.



## BEAM CLAMPS

STEEL ZINC • MALLEABLE IRON • STAINLESS

PART#	UPC#	SIZE	WT. PER PKG.	STD. PKG. UM
<b>STEEL ZINC</b>				
BC14	81525	1/4-20	1.16	10
BC38	81530	3/8-16	2.86	10
BC38C	81531	3/8-16	28.60	100
<b>MALLEABLE IRON</b>				
MBC14	81535	1/4-20	2.00	10
MBC38	81537	3/8-16	6.81	10
MBC12	81539	1/2-13	13.20	10
MBC58	81538	5/8-11	14.19	25
<b>STAINLESS</b>				
BC14SS	19686	1/4-20	1.00	10

OTHER SIZES AND QUANTITIES AVAILABLE BY REQUEST.



## SILVERHAWK™ TOP BEAM CLAMP

STEEL ZINC



PART#	UPC#	SIZE	WT. PER PKG.	STD. PKG. UM
SHUBC38	81532	3/8	1.88	10

OTHER SIZES AND QUANTITIES AVAILABLE BY REQUEST.



## SLIP-ON LOCK NUT KIT

STEEL ZINC

PART#	UPC#	QTY.	SIZE	WT. PER PKG.	STD. PKG. UM
SLNK1	22040	25 pcs	1/4 & 3/8	1.98	1
SLNK2	22041	50 pcs	3/8	2.00	1

OTHER SIZES AND QUANTITIES AVAILABLE BY REQUEST.



## SLIP-ON LOCK NUTS

STEEL ZINC

For Threaded Rod.

PART#	UPC#	SIZE	HEX SIZE	ACROSS CORNERS	HEIGHT	WT. PER PKG.	STD. PKG. UM
SLN14	22030	¼-20	.625	.715	.375	.11	5
SLN516	22032	5/16-18	.750	.865	.375	.17	5
SLN38	22034	3/8-16	.875	1.01	.490	.27	5
SLN38C	22120	3/8-16	.875	1.01	.490	5.37	100
SLN12	22036	½-13	1.068	1.23	.625	.48	5
SLN12C	22122	½-13	1.068	1.23	.625	9.99	100
SLN58	22043	5/8-11	1.31	1.52	.650	.75	5
SLN58C	22125	5/8-11	1.31	1.52	.650	14.99	100

OTHER SIZES AND QUANTITIES AVAILABLE BY REQUEST.



SQUARE

OCTAGONAL

## SWIVEL FIXTURE HANGERS

STEEL ZINC

For 4" Square and Octagonal Boxes.

PART#	UPC#	BOX	PIPE	WT. PER PKG.	STD. PKG. UM
MSC50	81541	Sq. box/pivot threaded	½ npt pipe	.71	1
MSC75	81543	Sq. box/pivot threaded	¾ npt pipe	.68	1
MSC50R	81545	Oct. box/pivot threaded	½ npt pipe	.63	1
MSC75R	81547	Oct. box/pivot threaded	¾ npt pipe	.59	1

PAINTED WHITE AVAILABLE BY SPECIAL QUOTE. OTHER SIZES AND QUANTITIES AVAILABLE BY REQUEST.



SQUARE

OCTAGONAL

## SWIVEL FIXTURE HANGERS

STEEL ZINC

- 20° swing from vertical
- Both load rated at 50 lbs.
- Rugged hinge construction
- Hands-free fixture hanger
- Single Electrician Installation
- Fits 4" square and round electrical boxes
- Fits ¾" pipe and includes a reducing bushing for ½" pipe

PART#	UPC#	SHAPE	WT. EACH	STD. PKG. UM
MSCU	81607	Square	.78	1
MSCUR	81609	Round	.72	1

OTHER SIZES AND QUANTITIES AVAILABLE BY REQUEST.

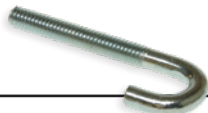

## J-BOLTS

STEEL ZINC • 18-8 STAINLESS STEEL • GALVANIZED



PART#	UPC#	THREAD LENGTH	THREAD SIZE/ OVERALL LENGTH	INSIDE HOOK DIA.	WT. PER PKG.	STD. PKG. UM
<b>STEEL ZINC</b>						
BTJ1	81055	1½	¼-20 x 2 <sup>5</sup> / <sub>16</sub>	7/16	.31	10
BTJ4	81061	1½	¼-20 x 4	7/16	.52	10
BTJ2	81057	2	5/16-18 x 3	½	.66	10
BTJ3	81059	2¼	3/8-16 x 3¾	5/8	1.18	10
BTJ7	20322	2¼	3/8-16 x 7	5/8	2.03	10
<b>18-8 STAINLESS STEEL</b>						
BTJ3SS	53355	2¼	3/8-16 x 3¾	5/8	1.18	10
BTJ7SS	98333	2¼	3/8-16 x 7	5/8	2.03	10
<b>GALVANIZED</b>						
BTJ6G	81656	2	½-13 x 3½	½	4.95	10

HEXAGON NUTS AND WASHERS ORDERED SEPARATELY. OTHER SIZES AND QUANTITIES AVAILABLE BY REQUEST.



## EYE BOLTS WITH HEX NUTS

STEEL ZINC • 18-8 STAINLESS • PLAIN

PART#	UPC#	THREAD LENGTH	THREAD SIZE	OVERALL LENGTH	INSIDE EYE SIZE	WT. PER PKG.	STD. PKG. UM
<b>STEEL ZINC</b>							
JEB6	80992	1¼	10-24	2	¾	2.17	100
JEB24	82245	1¾	10-24	3	¾	2.17	50
JEB1	80993	¾	¼-20	2	½	4.34	100
JEB2	80994	1¼	¼-20	2½	½	4.90	100
JEB3	80995	1¾	¼-20	3	½	5.36	100
JEB4	82220	2	¼-20	3½	½	5.86	100
JEB5	82225	2¾	¼-20	4	½	6.22	100
JEB9	82229	3	¼-20	5	½	7.45	100
JEB15	82236	3	¼-20	6	½	8.41	100
JEB32	82253	2¾	5/16-18	2¾	½	8.03	100
JEB33	82254	¼	5/16-18	3	½	2.43	25
EB12	22223	1½	3/8-16	2	1	14.60	100
EB13	22224	1½	3/8-16	3	1	14.80	100
JEB14	82235	2½	3/8-16	4	1¾	8.84	50
JEB8	81190	3	3/8-16	5	1¾	5.13	25
JEB11	82231	3	3/8-16	6	1¾	5.85	25
EB17	22247	3¾	3/8-16	8	1¾	7.50	25
EB16	22211	3	7/16-14	8	1	3.98	20
EB10	22230	4	7/16-14	10	1	5.20	10
EB19	22219	1½	½-13	2	1	1.74	25
JEB124	77824	3	½-13	4	1	3.57	10
JEB100*	82248	3	½-13	4	1	4.01	10
EB18	22248	4	½-13	12	1	3.70	20
<b>18-8 STAINLESS</b>							
JEB1SS	94451	¾	¼-20	2	½	4.25	100
JEB3SS	94453	1¾	¼-20	3	½	5.48	100
JEB3XXSS	99580	1¾	¼-20	3	½	1.10	20
JEB5SS	94455	2¾	¼-20	4	½	6.22	100
JEB13SS	94463	2¾	3/8-16	3¾	¾	4.01	25
EB14SS	22214	2	3/8-16	4	¾	18.07	100
JEB124SS	98187	1¼	½-13	4	2¾/16	10.55	25

OTHER SIZES AND QUANTITIES AVAILABLE BY REQUEST.



With Lag Screw Thread

## SCREW EYES DOMESTIC STEEL ZINC



PART#	UPC#	OVERALL LENGTH	HOLE DIAMETER	THREAD DIAMETER	THREAD LENGTH	WT. PER PKG.	STD. PKG. UM
<b>DOMESTIC STEEL ZINC</b>							
JSE1	80996	1 <sup>5</sup> / <sub>16</sub>	½	#8	½	.83	100
JSE2	80997	1 <sup>5</sup> / <sub>16</sub>	5/8	¼	¾	1.58	100
JSE3	80998	2 <sup>3</sup> / <sub>16</sub>	1 <sup>1</sup> / <sub>16</sub>	9/32	7/8	4.06	100
JSE4	81415	2 <sup>5</sup> / <sub>8</sub>	¾	5/16	1	6.82	100
JSE13	81423	8	1-1/8	9/16	2 <sup>5</sup> / <sub>8</sub>	4.71	10
SE6	22416	8	7/16	7/16	2 <sup>7</sup> / <sub>8</sub>	11.50	25
<b>STEEL ZINC</b>							
JSE5	81416	3¾	½	¼	¾	6.65	100
JSE7	81414	5½	¾	7/16	2 <sup>1</sup> / <sub>8</sub>	8.27	25
SE8	22418	5¼	1	½	2½	13.00	50
SE10	22420	8	1/8	9/16	2 <sup>5</sup> / <sub>8</sub>	11.50	25

OTHER SIZES AND QUANTITIES AVAILABLE BY REQUEST.



STEEL ZINC

**S-HOOKS**  
STEEL ZINC • 18-8 STAINLESS



18-8 STAINLESS

PART#	UPC#	LENGTH	WIRE DIAMETER	WT. PER PKG.	USE WITH	STD. PKG. UM
<b>STEEL ZINC</b>						
JSHK1A	81006	¾	.071	.35	JC14	100
JSHK0	81043	7/8	.092	.38	JC14	100
JSHK6	26261	1	.120	.76	JC12/JC14	100
SHK6B	26262	1	.120	7.17	JC12/JC14	1000
JSHK1	81005	1¼	.105	.74	JC12/JC14	100
SHK15M	73957	1¼	.105	34.23	JC12/JC14	5000
JSHK2	81007	1½	.135	1.39	JC10/JC12	100
JSHK2A	81008	1¾	.186	3.12	JC10/JC12	100
JSHK3	81009	2	.243	5.63	JC10	100
SHK120	22303	2¾	.190	5.01	JC10/JC12	100
JSHK4	82256	3	.312	6.16	JC10	50
JSHK5	82260	3½	.375	5.56	JC10	25
<b>18-8 STAINLESS</b>						
JSHK0ASS	82301	¾	.092	.38	JC14	100
JSHK1SS	82401	1¼	.148	1.17	JC12/JC14	100
JSHK2SS	82306	1½	.184	2.30	JC12/JC14	100
JSHK2ASS	82265	1¾	.192	3.21	JC10/JC12	100
JSHK3SS	82270	2	.250	6.20	JC10	100

OTHER SIZES AND QUANTITIES AVAILABLE BY REQUEST.



**SCREW HOOKS**

STEEL ZINC  
With Lag Screw Thread

PART#	UPC#	LENGTH	WIRE DIAMETER	WT. PER PKG.	STD. PKG. UM
JSH1	83500	2	.135	1.20	100
JSH2	83505	3 <sup>3</sup> / <sub>8</sub>	.192	3.92	100
SH3	22510	4 <sup>1</sup> / <sub>8</sub>	.244	8.00	100

OTHER SIZES AND QUANTITIES AVAILABLE BY REQUEST.



**TIE WIRE**

LOW TENSILE STEEL • 18-8 STAINLESS • PVC COATED

PART#	UPC#	GAUGE	LENGTH	WT. PER PKG.	STD. PKG. UM
<b>LOW TENSILE STEEL</b>					
MTW9	16118	9	85'	5.00	1
MTW12	16120	12	165'	6.00	1
MTW123M	16129	12	3000'	89.00	1
MTW124M	16130	12	4000'	118.00	1
MTW14	16127	14	290'	3.50	1
MTW14M	16140	14	1000'	17.00	1
MTW16	16125	16	350'	70.60	20 Coils (min. purchase)
MTW17	22307	16/Galvanized	500'	66.00	12 Spools (min. purchase)
MTW1725	22308	16/Galvanized	350'	71.60	20 Coils (min. purchase)
MTW18	22313	18	350'	13.00	1
<b>18-8 STAINLESS</b>					
MTW16SS1LB	22293	16	96'	1.00	1
MTW16SSP	22292	16	1152'	2.40	1
<b>PVC COATED</b>					
MTW9163	22324	16 Gauge PVC Coated Rebar			20 Coils/box

OTHER SIZES AND QUANTITIES AVAILABLE BY REQUEST.

# FIXTURE HANGING ACCESSORIES



## PRE-TIED CEILING WIRE

SINGLE LOOP • STRAIGHT NO LOOP • PIN & CLIP • CLIP ONLY

PART#	UPC#	LENGTH	TYPE	WT. PER PKG.	STD. PKG. UM
SWL612	16174	6'	single loop	20.00	100 pcs
SWL1212	16177	12'	single loop	39.00	100 pcs
SWL1612	16179	16'	single loop	52.00	100 pcs
SWLS126	16182	6'	straight no loop	19.00	100 pcs
SWLS910	16180	10'	straight no loop	31.00	100 pcs
SWLS1210	16176	10'	straight no loop	31.00	100 pcs
SWLS912	16184	12'	straight no loop	30.00	100 pcs
SWLS1212	16178	12'	straight no loop	36.00	100 pcs
SWP612	26612	6'	pin & clip	20.00	100 pcs
SWP812	26714	8'	pin & clip	27.00	100 pcs
SWP1012	26716	10'	pin & clip	37.00	100 pcs
SWP1212	26717	12'	pin & clip	39.00	100 pcs
SWP1612	26721	16'	pin & clip	57.00	100 pcs
SWPC1212	26712	12'	clip only	34.00	100 pcs

OTHER SIZES AND QUANTITIES AVAILABLE BY REQUEST.



## TIE WIRE DISPENSER

MOUNTS ON TOOL BELT • METAL • PLASTIC  
A Very Handy Way To Store & Dispense Tie Wire

PART#	UPC#	WT. PER PKG.	STD. PKG. UM
MWD1 (Plastic)	16101	1.07	1
MWDM1 (Metal)	16120	2.00	1



## JACK CHAIN

STEEL GALVANIZED • 18-8 STAINLESS

PART#	UPC#	TRADE SIZE	SIZE ACROSS LINK	WORK LOAD/LIMIT	WT. PER PKG.	STD. PKG. UM
<b>STEEL GALVANIZED</b>						
JC6	21528	#6	1/4	88	28.50	100' box
JC8	21511	#8	1/8	60	20.50	100' box
JC10	21515	#10	1/2	43	7.35	50' box
JC10T	21513	#10	1/2	43	26.00	250' pail
JC10F	21514	#10	1/2	43	77.00	500' pail
JC10CB	21498	#10	1/2	43	15.00	100' box
JC12	21500	#12	3/8	29	4.12	50' box
JC12C	21505	#12	3/8	29	8.30	100' reel
JC12CB	21507	#12	3/8	29	8.23	100' box
JC12CCL	21512	#12	3/8	29	21.25	250' reel
JC12M	21510	#12	3/8	29	82.30	1000' pail
JC14	21518	#14	1/4	16	5.50	100' box
JC14M	21519	#14	1/4	16	53.50	1000' reel
JC16	21508	#16	5/64	11	3.00	100' box
JC18CB	21535	#18	3/16	5	1.85	100' box
<b>18-8 STAINLESS</b>						
JC10SS	21516	#10	1/2	43	7.66	50' box
JC10CBSS	21517	#10	1/2	43	15.13	100' box
JC12SS	21501	#12	3/8	29	4.36	50' box
JC12CSS	21506	#12	3/8	29	8.72	100' box
JC12MSS	21502	#12	3/8	29	89.20	1000' box
JC16SS	21523	#16	5/64	11	3.08	100' box
JC18SS	21534	#18	3/16	5	1.79	100' box

OTHER SIZES AND QUANTITIES AVAILABLE BY REQUEST.





**FIXTURE HANGING CHAIN**  
PLAIN STEEL FINISH WITH LACQUER

PART#	UPC#	LINK LENGTH	LINK WIDTH	LINK THICKNESS	WT. PER PKG.	STD. PKG. UM
FHC1	21410	2¼	¾	.148	44.15	(100) 3' Pieces

OTHER SIZES AND QUANTITIES AVAILABLE BY REQUEST.



**DOUBLE LOOP CHAIN**  
STEEL GALVANIZED • 18-8 STAINLESS

PART#	UPC#	TRADE SIZE	WIRE DIA.	WORK LOAD LIMIT	WT. PER PKG.	STD. PKG. UM
<b>STEEL GALVANIZED</b>						
DLC1	21550	#1	.105	155	11.10	100' Box
DLC1S	21555	#1	.105	155	27.75	250' Spool
DLC2	21556	#2	.092	115	8.00	100' Box
DLC3	21560	#3	.080	90	6.80	100' Box
DLC3S	21565	#3	.080	90	16.00	250' Spool
DLC4	21586	#4	.072	70	5.00	100' Box
DLC2/0	21557	#2/0	.135	255	42.50	250' Box
<b>18-8 STAINLESS</b>						
SDLC1	21569	#1	.105	155	11.00	100' Box
SDLC3	21570	#3	.080	90	6.34	100' Box

OTHER SIZES AND QUANTITIES AVAILABLE BY REQUEST.



**SASH CHAIN**

PART#	UPC#	TRADE SIZE	SIZE ACROSS LINK	WORK LOAD/LIMIT	WT. PER PKG.	STD. PKG. UM
<b>STEEL GALVANIZED</b>						
JC35SC	21509	#35	.57	106	6.10	100'
JC50SC	21526	#50	.67	225	11.05	100'

OTHER SIZES AND QUANTITIES AVAILABLE BY REQUEST.

**F**

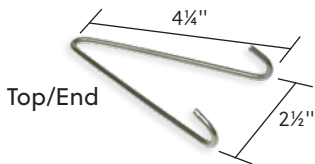

Top/End

**FIXTURE HOOKS**

STEEL ZINC

For Hanging Industrial Light Fixtures

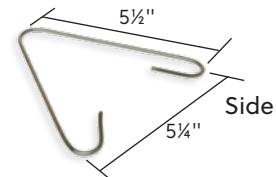

Side

PART#	UPC#	MOUNT	WT. PER PKG.	STD. PKG. UM
FHK1	21400	Top/End Mount	4.50	100
FHK2	21405	Side Mount	4.80	100

OTHER SIZES AND QUANTITIES AVAILABLE BY REQUEST.

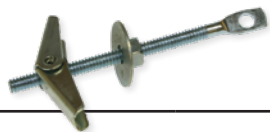

**TIE WIRE ACOUSTICAL TOGGLE BOLTS**  
STEEL ZINC

- (1) Tie wire ¼ -20 toggle bolt
- (1) ¼ -20 nut
- (1) ¼ washer
- (1) ¼ toggle wing

PART#	UPC#	DIAMETER	LENGTH	WT. PER PKG.	STD. PKG. UM
JTWA144	81402	¼	4	2.47	25
JTWA145	81404	¼	5	2.89	25

OTHER SIZES AND QUANTITIES AVAILABLE BY REQUEST.



# FIXTURE HANGING ACCESSORIES



## TIE WIRE WEDGE ANCHORS

STEEL ZINC WITH STAINLESS STEEL CLIP

For Various Overhead Suspension Applications

PART#	UPC#	DIAMETER	OVERALL LENGTH	MIN. DEPTH IN LENGTH	WT. PER PKG.	STD. PKG. UM
JTWA200	81408	¼	2	1 <sup>3</sup> / <sub>8</sub>	2.36	100
JTWA57	81409	5 <sup>5</sup> / <sub>16</sub>	1½	1	2.51	100

OTHER SIZES AND QUANTITIES AVAILABLE BY REQUEST.



## HANGER BOLTS

STEEL ZINC • PLAIN

PART#	UPC#	DESCRIPTION	WT. PER PKG.	STD. PKG. UM
<b>STEEL ZINC</b>				
JHAB14	82747	8-32 x 1½	.63	100
JHAB9	81000	10-24 x 2	1.12	100
JHAB10	81001	¼-20 x 3	3.10	100
JHAB11	81002	3 <sup>3</sup> / <sub>8</sub> -16 x 3	7.65	100
JHAB13	84111	3 <sup>3</sup> / <sub>8</sub> -16 x 4	9.42	100
HAB15B	23289	3 <sup>3</sup> / <sub>8</sub> -16 x 4½	25.67	250
JHAB12	84110	3 <sup>3</sup> / <sub>8</sub> -16 x 6	7.31	50
HAB12B	23281	3 <sup>3</sup> / <sub>8</sub> -16 x 6	18.41	125
HAB17	23284	3 <sup>3</sup> / <sub>8</sub> -16 x 8	17.50	50
<b>PLAIN</b>				
HAB13PLB	20130	3 <sup>3</sup> / <sub>8</sub> -16 x 4	24.14	250
HAB15PLB	23283	3 <sup>3</sup> / <sub>8</sub> -16 x 4½	25.00	250
HAB12PLB	23282	3 <sup>3</sup> / <sub>8</sub> -16 x 6	18.00	125

OTHER SIZES AND QUANTITIES AVAILABLE BY REQUEST.



## HANGER BOLT DRIVERS

With ¼ Power Hex Shanks Internal Threads For Driving Hanger Bolts And Threaded Rod

PART#	UPC#	DIAMETER	LENGTH	WT. PER PKG.	STD. PKG. UM
HABD14	23273	8-32	2 <sup>9</sup> / <sub>16</sub>	.06	1
HABD9	23274	10-24	2 <sup>9</sup> / <sub>16</sub>	.06	1
HABD10	23275	¼-20	2 <sup>9</sup> / <sub>16</sub>	.06	1
HABD12	23280	3 <sup>3</sup> / <sub>8</sub> -16	2 <sup>9</sup> / <sub>16</sub>	.08	1

OTHER SIZES AND QUANTITIES AVAILABLE BY REQUEST.



## ACOUSTICAL LAG SCREWS

STEEL ZINC

For Use In Tie Wire And Jack Chain Applications For Wood Application

PART#	UPC#	THREAD SIZE	OVERALL LENGTH	WT. PER PKG.	STD. PKG. UM
JALS14	81003	¼	3	1.19	50
JALS15	77915	¼	4	3.61	100

OTHER SIZES AND QUANTITIES AVAILABLE BY REQUEST.



## ACOUSTICAL DRILL SCREW

STEEL ZINC

Designed To Penetrate 16-18 Gauge Steel Stud For Hanging Acoustical Ceilings

PART#	UPC#	THREAD SIZE	OVERALL LENGTH	WT. PER PKG.	STD. PKG. UM
JATEK1	82020	¼	2	1.05	50

OTHER SIZES AND QUANTITIES AVAILABLE BY REQUEST.





**ACOUSTICAL CEILING EYELET TIE WIRE**

*Hanging System for Wood and Steel*

PART#	UPC#	EYE HOLE	DIA.	LENGTH	DRIVER	WT. PER PKG.	STD. PKG. UM
<b>METAL</b>							
JPFMMAC2231500	17378	3/16	1/4	3	PFMD2201350	.48	25
JPFMMAC2231550	17379	3/16	1/4	3 1/4	PFMD2201350	.25	25
<b>WOOD</b>							
JPFMWAC2251500	17355	3/16	1/4	3	PFMD2201350	.42	25



**I-LAG™ ACOUSTICAL SCREWS**

*For Metal*

PART#	UPC#	MATERIAL	DIAMETER	LENGTH	THREAD LENGTH	POINT	WT. PER PKG.	STD. PKG. UM
JATEK150PP	82405	Yellow Zinc	1/4 - 14	2 7/8	1 1/4	Punch	3.15	100
JATEK150SP	82404	Yellow Zinc	1/4 - 14	2 3/4	1 1/2	Sharp	3.20	100
AATEK175SD	82021	Yellow Zinc	1/4 - 14	3 1/4	1 3/4	Self-Drill	31.77	1000
JATEK225SDC	82406	Yellow Zinc	1/4 - 14	3 3/4	2 1/4	Self-Drill	3.25	100
JATEK750SD	82402	Yellow Zinc	1/4 - 14	2	1/2	Self-Drill	2.00	100
JATEKELDX	82403	Blue Ruspert	1/4 - 14	2 1/4	3/4	Self-Drill	2.00	100

F



**I-LAG™ ACOUSTICAL SCREWS**

*For Wood*

PART#	UPC#	MATERIAL	DIAMETER	LENGTH	THREAD LENGTH	POINT	WT. PER PKG.	STD. PKG. UM
JATEKW300	82408	Steel Plain	1/4 - 14	3	1 1/2	Sharp	2.30	100
JATEKW300CSS	82407	316 SS	1/4 - 14	3	1 1/2	Sharp	2.50	100
JATEKW300ZP	82409	Steel Zinc	1/4 - 14	3	1 1/2	Sharp	2.30	100
JATEKW400ZP	82410	Steel Zinc	1/4 - 14	4	1 1/2	Sharp	3.20	100
JATEKW500ZP	82411	Steel Zinc	1/4 - 14	5	1 1/2	Sharp	4.00	100
JATEKW600ZP	82412	Steel Zinc	1/4 - 14	6	1 1/2	Sharp	4.80	100

**ACOUSTICAL LAG & ACOUSTICAL DRILL SCREW DRIVER**



PART#	UPC#	SIZE	WT. PER PKG.	STD. PKG. UM
ALSD	22050	7/16 X 2 3/16	.13	1

OTHER SIZES AND QUANTITIES AVAILABLE BY REQUEST.



## EYE COUPLING

STEEL ZINC

For Use In Tie Wire Or Jack Chain Applications

PART#	UPC#	DIAMETER	OVERALL LENGTH	WT. PER PKG.	STD. PKG. UM
JECN163	72140	¼-20	1	1.63	100
JEC44	81004	¼-20	1½	2.29	100
EC44M	81401	¼-20	1½	23.10	1000
EC44B	90310	¼-20	1½	57.75	2500
JEC55	21733	¾-16	2	6.14	100

OTHER SIZES AND QUANTITIES AVAILABLE BY REQUEST.



## RIZE KWIK-LOC™ SYSTEM

A fast and easy way to hang signs, florescent fixtures, speakers, busbars, cable trays, and piping just to name a few.

**No Tools Needed and KWIK-LOCS™ are reusable!**

Kwik-Loc™ with 3/32 cable will safely suspend 150 lbs vertical.

NOTE: Suspension at angles does reduce safe working load.

### WEIGHT CHART

SIZE	VERTICAL	15°	30°	45°	60°
3/32	150 lbs	144 lbs	129 lbs	105 lbs	75 lbs

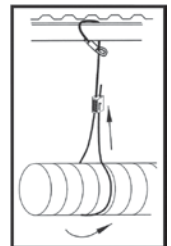

RIZE Kwik-Loc™ System can be purchased in kits or individually

PART#	UPC#	DIAMETER LOOP CABLE	CABLE LENGTH	WT. PER PKG.	STD. PKG. UM
RLCK5	23055	3/32	5'	.15	1
RLCK10	23060	3/32	10'	.23	1
MKL100	23082	Kwik-Loc™ only for 1/16 & 3/32	-	.05	1
RLC5	23065	3/32	5'	.10	1
RLC10	23070	3/32	10'	.18	1
RLC500	23066	3/32	550'	5.51	1
KL600	51088	Kwik-Loc™ for WC8 Cable	-	.20	1



All Kwik-Locs have been tested to UL 1598 and are listed under File # E246601

## HANGERMATE®+

Rod Hanging System for Concrete, Wood and Steel

Threaded Rod Anchor System



PART#	UPC#	ROD SIZE	DIA.	LENGTH	DRIVER	WT. PER PKG.	STD. PKG. UM	
<b>VERTICAL CONCRETE</b>								
JPFMCV2211100	17329	¼-20	¼	1⅝	PFMD2201250	.88	25	
JPFMCV2211200	17330	¾-16	¼	1⅝	PFMD149100	1.25	25	
JPFMCV2211250	17331	¾-16	¼	2½	PFMD149100	1.50	25	
<b>EXTERNAL THREAD</b>								
JPFMCVE1421000	17332	¾-16	¼	1⅝	DWD22862	1.25	25	
JPFMCVE1421050	17333	¾-16	¼	2½	DWD22862	1.50	25	
PFMA2201050	17340	Adaptor which converts hanger from ¾ to accept ½.						25
<b>DUAL DIRECTION CONCRETE</b>								
JPFMCDD2271050	17335	¾-16	5/16	2¼	PFMD2201300	2.53	25	
<b>ANGLED CONCRETE</b>								
JPFMCPC2281300	17334	¾-16	¼-20	2	PFMD2201250	2.00	25	

CONTINUED

## HANGER<sup>®</sup>+

Rod Hanging System for Concrete, Wood and Steel

Threaded Rod  
Anchor System



PART#	UPC#	ROD SIZE	DIA.	LENGTH	DRIVER	WT. PER PKG.	STD. PKG. UM
<b>VERTICAL WOOD</b>							
JPFMWV2251000	17342	¼-20	¼	2	PFMD2201150	1.75	25
JPFMWV2251050	17348	¾-16	¼	1	PFMD2201150	1.65	25
JPFMWV2251100	17347	¾-16	¼	2	PFMD2201150	1.80	25
JPFMWV2251150	17346	¾-16	5/16	2½	PFMD2201150	2.28	25
JPFMWV2251200	17345	¾-16	¼	3	PFMD2201150	2.15	25
JPFMWV2251250	17343	¾-16	¼	4	PFMD2201150	2.38	25
JPFMWV2251300	17344	½-13	5/16	2½	PFMD2201150	2.03	25
<b>HORIZONTAL WOOD</b>							
JPFMWH2261000	17349	¼-20	¼	1	PFMD2201150	1.85	25
JPFMWH2261050	17350	¾-16	¼	1	PFMD2201150	1.58	25
JPFMWH2261100	17351	¾-16	¼	2	PFMD2201150	1.75	25
JPFMWH2261150	17352	¾-16	5/16	2½	PFMD2201150	1.85	25
JPFMWP2281100	17353	¾-16	¼	2	PFMD2201250	1.63	25
<b>DUAL DIRECTION WOOD</b>							
JPFMWDD2271000	17354	¾-16	5/16	2¼	PFMD2201300	2.53	25
<b>VERTICAL STEEL</b>							
JPFMMV2231000	17358	¼-20	¼-20	1	PFMD2201200	1.84	25
JPFMMV2231100	17359	¾-16	¼-20	1	PFMD2201200	1.84	25
JPFMMV223110N	17360	¾-16	¼-20	1	PFMD2201200	1.90	25
JPFMMV2231150	17361	¾-16	¼-20	1½	PFMD2201200	1.80	25
JPFMMV223115N	17362	¾-16	¼-20	1½	PFMD2201200	1.92	25
JPFMMV2231200	17363	¾-16	¼-20	1½	PFMD2201200	1.92	25
JPFMMV223120N	17364	¾-16	¼-20	1½	PFMD2201200	1.92	25
JPFMMV2231250	17365	¾-16	¼-20	2	PFMD2201200	1.94	25
<b>HORIZONTAL STEEL</b>							
JPFMMH2241100	17366	¾-16	¼-20	1	PFMD2201200	1.90	25
JPFMMH224110N	17367	¾-16	¼-20	1	PFMD2201200	1.90	25
JPFMMH2241150	17368	¾-16	¼-20	1½	PFMD2201200	1.80	25
JPFMMH224115N	17369	¾-16	¼-20	1½	PFMD2201200	1.92	25
JPFMMH2241200	17370	¾-16	¼-20	1½	PFMD2201200	1.80	25
JPFMMH224120N	17371	¾-16	¼-20	1½	PFMD2201200	1.93	25
<b>DUAL DIRECTION STEEL</b>							
JPFMD227110N	17375	¾-16	¼-20	1	PFMD2201300	2.23	25
JPFMD227120N	17376	¾-16	¼-20	1½	PFMD2201300	2.28	25
JPFMD227130N	17377	¾-16	¼-20	1½	PFMD2201300	2.28	25
<b>ANGLED STEEL</b>							
JPFMMP2281150	17372	¾-16	¼-20	1	PFMD2201250	1.63	25
JPFMMP2281200	17373	¾-16	12-20	1¾	PFMD2201250	1.88	25
JPFMMP2281250	17374	¾-16	¼-14	1	PFMD2201250	1.63	25

F

# FIXTURE HANGING ACCESSORIES

## HANGER MATE®+ DRIVERS

For Concrete, Wood and Steel Vertical and Horizontal Rod Hanger



CONCRETE DRIVER



WOOD SOCKET DRIVER



STEEL SOCKET DRIVER



ANGLED DRIVER



DUAL DIRECTION DRIVER



CEILING SCREW EYELET DRIVER

PART#	UPC#	TYPE	HANGER/ROD SIZE	WT. PER PKG.	STD. PKG. UM
PFMA2201050	17340	Concrete, Steel	½" Rod (¾" to ½") Adaptor	1.28	25
PFMD149100	17337	Concrete	Vertical – ¾ Rod (Powers/Dewalt)	.39	1
DWD22862	17339	Concrete	Vertical – ¾ Rod (Powers/Dewalt)	.34	1
PFMD1491100	41327	Concrete	Vertical – ¾ Rod (Powers/Dewalt)	.31	1
PFMD1491050	17336	Concrete	Vertical – ¼ Rod (Powers/Dewalt)	.31	1
PFMD2201150	17356	Wood	Vertical/Horizontal – ¼ & ¾ Rod (Powers/Dewalt)	.48	1
PFMD2201200	17380	Steel	Vertical/Horizontal – ¼ & ¾ Rod	.55	1
PFMD2201250	17338	Wood, Steel, Concrete	Angled – ¾ Rod (Powers/Dewalt)	.56	1
PFMD2201300	17341	Wood, Steel, Concrete	Dual Direction – ¾ Rod	.55	1
PFMD2201350	17357	Wood, Steel	Acoustical Ceiling Eyelet Hanger Tie Wire	.50	1

## HORIZONTAL MOUNT THREADED ROD ANCHOR SYSTEM

STEEL ZINC

Saves Time And Cost From Traditional Hanging Methods

**DRILL,  
DRIVE,  
DONE!**



PART#	JAR UPC#	ROD SIZE	DESCRIPTION	WT. PER PKG.	STD. PKG. UM
<b>WOOD</b>					
JRWH25100	31853	¼-20	¼ x 1 Type 17 Point	2.00	25
JRWH37200	31855	¾-16	¼ x 2 Type 17 Point	2.00	25
JRWH37212	31856	¾-16	5/16 x 2½ Type 17 Point	2.00	25



<b>METAL</b>					
JRSH25100N	31830	¼-20	¼ x 1 #3 Drill Point with Nut	2.00	25
JRSH251125	31831	¼-20	12-20 x 1½ #5 Drill Point	2.00	25
JRSH37100N	31833	¾-16	¼ x 1 #3 Drill Point with Nut	2.00	25
JRSH37112N5	31834	¾-16	12-20 x 1½ #5 Drill Point with Nut	2.00	25



<b>DRIVER</b>					
RND62	31878	¼ & ¾	Driver (For Wood and Metal Only)	.10	1

**VERTICAL MOUNT THREADED ROD ANCHOR SYSTEM**

STEEL ZINC

Saves Time And Cost From Traditional Hanging Methods

**DRILL,  
DRIVE,  
DONE!**



PART#	JAR UPC#	ROD SIZE	DESCRIPTION	WT. PER PKG.	STD. PKG. UM
<b>WOOD</b>					
JRWV25200	31859	¼-20	¼ x 2 Type 17 Point	2.00	25
JRWV37100	31861	¾-16	¼ x 1 Type 17 Point	2.00	25
JRWV37200	31862	¾-16	¼ x 2 Type 17 Point	2.00	25
JRWV37212	31863	¾-16	5/16 x 2½ Type 17 Point	2.00	25



<b>METAL</b>					
JRSV25100	31840	¼-20	¼ x 1 #3 Drill Point	2.00	25
JRSV37100N	31842	¾-16	¼ x 1 #3 Drill Point with Nut	2.00	25
JRSV37112	31843	¾-16	¼ x 1½ #3 Drill Point	2.00	25
JRSV37112N	31844	¾-16	¼ x 1½ #3 Drill Point with Nut	2.00	25
JRSV37112N5	31845	¾-16	12-20 x 1½ #5 Drill Point with Nut	2.00	25
JRSV37200	31847	¾-16	¼ x 2 #3 Drill Point	2.00	25



<b>CONCRETE</b>					
JTHD25112RH	31867	¼-20	¼ x 1½ (Use 3/8 Socket)	1.00	25
JTHDB37158RH	31868	¾-16	¼ x 1-5/8 (Use ½ Socket)	1.72	25
JTHD50234RH	31873	½-13	½ x 2¾ (Use 11/16 Socket)	4.00	25



<b>DRIVER</b>					
RND62	31878	¼ & ¾	Driver (For Wood and Metal Only)	.10	1

F

**STEEL DECKING THREADED ROD ANCHOR SYSTEM**

STEEL ZINC

Saves Time And Cost From Traditional Hanging Methods

**DRILL,  
DRIVE,  
DONE!**



SMXB1



SMXK1



Step 1 Step 2 Step 3 Step 4 Completed Installation

Expands to provide direct Vertical attachment in:

- Metal Deck (16-22 gauge)
- Z Purlin (16-18 gauge)
- Install in seconds
- Retaining nut is not required

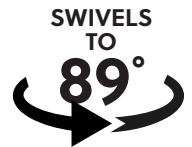

SWIVELS TO 89°

PART#	UPC#	MOUNT	ROD SIZE	WT. PER PKG.	STD. PKG. UM
JSMX1	41435	Vertical	¼-20	.44	5
JSMX125	41570	Vertical	¼-20	2.02	25
JSMX2	41440	Vertical	¾-16	.45	5
JSMX225	41572	Vertical	¾-16	2.05	25
JSMXP35	41580	Vertical Swivel	¾-16	.48	5
JSMXP3525	41625	Vertical Swivel	¾-16	2.40	25
SMXK1	41445	*Installation tool		1.01	1
SMXB1	41450	*25/64 Custom Drill Bit for Tool		.09	1

Installation Kit Includes: Sleeve, bit receiver, hex wrench, and 25/64 drill bit

PLEASE CALL FOR TECHNICAL INFORMATION



# FIXTURE HANGING ACCESSORIES

## BRIDLE RINGS

STEEL ZINC



PART#	UPC#	LOOP SIZE	THREAD SIZE	WT. PER PKG.	STD. PKG. UM
<b>MACHINE SCREW THREAD</b>					
MBR125	81557	1¼	¼-20	.72	10
MBR125B	81564	1¼	¼-20	1.75	25
MBR150	81559	1½	¼-20	.81	10
MBR200	81561	2	¼-20	.97	10
<b>WOOD SCREW THREAD</b>					
MBR100WS	81560	1	.230	.58	10
MBR150WS	81563	1½	.230	.79	10
MBR200WS	81565	2	.230	.98	10

OTHER SIZES AND QUANTITIES AVAILABLE BY REQUEST



## CEILING COVER PLATES ADJUSTABLE

ADJUSTS TO FIT 3" OR 4" OUTLET BOXES

Includes plate, adjustable strap and flat head slotted machine screw.

White color to suit most applications.

PART#	UPC#	BOX SIZES	CANOPY SIZE	WT. PER PKG.	STD. PKG. UM
CP1A	41300	3 & 4	5¼	.12	10

OTHER SIZES AND QUANTITIES AVAILABLE BY REQUEST



## CEILING COVER PLATES STANDARD

ATTACHES DIRECTLY TO CEILING OUTLET BOXES

Holes predrilled. Flat head slotted machine screws included.

White color to suit most applications.

PART#	UPC#	BOX SIZES	CANOPY SIZE	WT. PER PKG.	STD. PKG. UM
CP3S	41305	3	5¼	1.88	10
CP4S	41310	4	5¼	1.91	10

OTHER SIZES AND QUANTITIES AVAILABLE BY REQUEST



METALLICS IS THE ONLY FASTENER SUPPLIER TO AMERICA'S DISTRIBUTORS TO MANUFACTURE ITS OWN GROUNDING SCREWS



**GROUNDING SCREWS**

ROUND HEAD WASHER "COMBO" SLOTTED/PHILLIPS  
STEEL GREEN ZINC



PART#	BOX UPC#	JAR UPC#	DIAMETER	LENGTH	WT. PER PKG.	STD. PKG. UM
GS20	16105		10-32	3/8	.58	100
JGS20		82643	10-32	3/8	.54	100
GS20500		82005	10-32	3/8	2.75	500

OTHER SIZES AND QUANTITIES AVAILABLE BY REQUEST – BOX, PLASTIC HANGING CLAMSHELL



**GROUNDING SCREWS**

HEX WASHER "COMBO" SLOTTED/PHILLIPS  
DOG POINT - STEEL GREEN ZINC



PART#	BOX UPC#	JAR UPC#	DIAMETER	LENGTH	WT. PER PKG.	STD. PKG. UM
GSH19	82086		8-32	5/16 Type F	.36	100
JGSH19		82079	8-32	5/16 Type F	.35	100
GSH24	82087		10-32	3/8 Type F	.55	100
JGSH24		82092	10-32	3/8 Type F	.57	100
GSH20	16110		10-32	3/8	.57	100
JGSH20		82080	10-32	3/8	.51	100
GSH20500		82010	10-32	3/8	2.45	500
GSH205M	82103		10-32	3/8	22.85	5000
GSH208M	82104		10-32	3/8	37.20	8000

OTHER SIZES AND QUANTITIES AVAILABLE BY REQUEST – BOX, PLASTIC HANGING CLAMSHELL



**GROUNDING SCREWS**

HEX WASHER "COMBO" SLOTTED/PHILLIPS  
TYPE 23 THREAD CUTTING  
STEEL GREEN ZINC



PART#	BOX UPC#	JAR UPC#	DIAMETER	LENGTH	WT. PER PKG.	STD. PKG. UM
JGSH15*		39496	8-32	1/4	.30	100
GSH1510M*	82101		8-32	1/4	26.74	10000
GSH23	16115		10-32	3/8	.51	100
JGSH23		82091	10-32	3/8	.54	100
GSH23500		82015	10-32	3/8	2.55	500
GSH2310M		82016	10-32	3/8	51.0	10000
JGSH14		82074	1/4-20	1/2	1.20	100

\*SLOTTED ONLY, DENOTES A PRODUCT NOT MANUFACTURED IN THE USA.

OTHER SIZES AND QUANTITIES AVAILABLE BY REQUEST – BOX, PLASTIC HANGING CLAMSHELL



**GROUNDING SCREWS**

"QUADRIVE" HEX WASHER, SLOTTED, PHILLIPS  
AND SQUARE DRIVE DOG POINT  
STEEL GREEN ZINC



Four drives in one head



PART#	BOX UPC#	JAR UPC#	DIAMETER	LENGTH	WT. PER PKG.	STD. PKG. UM
GSH21	16111		10-32	3/8	.65	100
JGSH21		82081	10-32	3/8	.63	100
GSH21500		82011	10-32	3/8	2.99	500
GSH21M	82085		10-32	3/8	5.14	1000

OTHER SIZES AND QUANTITIES AVAILABLE BY REQUEST – BOX PLASTIC HANGING CLAMSHELL

Introduced in 1999

# SPECIAL PURPOSE ELECTRICAL FASTENERS

## The QuaDrive

Four drives  
in one head

-  Hex
-  Slotted
-  Phillips
-  Square Drive

Introduced  
in 1999



## GROUNDING SCREWS

"QUADRIVE" HEX WASHER, SLOTTED/PHILLIPS  
AND SQUARE DRIVE - TYPE 23 THREAD CUTTING  
STEEL GREEN ZINC



PART#	BOX UPC#	JAR UPC#	DIAMETER	LENGTH	WT. PER PKG.	STD. PKG. UM
GSH22	16112		10-32	3/8	.53	100
JGSH22		82090	10-32	3/8	.57	100
GSH22500		82012	10-32	3/8	2.97	500

OTHER SIZES AND QUANTITIES AVAILABLE BY REQUEST - BOX, PLASTIC HANGING OR CLAMSHELL

## GROUNDING CLIPS

STEEL GREEN ZINC

Designed To Fit #10-#12-#14 Copper or Aluminum Wire



PART#	BOX UPC#	JAR UPC#	WT. PER PKG.	STD. PKG. UM
CG20	16100		.42	100
JCG20		82649	.40	100
CG20500		83100	1.89	500
CG202500	83099		10.5	2500

OTHER SIZES AND QUANTITIES AVAILABLE BY REQUEST - BOX, PLASTIC HANGING OR CLAMSHELL

-  Hex
-  Slotted
-  Phillips

7 inch

## GROUNDING PIGTAILS

WITH HEX WASHER "COMBO" SLOTTED/PHILLIPS  
DOG POINT • STEEL GREEN ZINC

Wire



PART#	UPC#	SIZE	WT. PER PKG.	STD. PKG. UM
<b>SOLID COPPER INSULATED WIRE</b>				
PT30	16000	#14 Wire	1.41	100 box
PT30M	16013	#14 Wire	15.10	1000 box
PT40	16005	#12 Wire	1.88	100 box
PT40K	10679	#12 Wire	4.77	250 jar
PT40J	16039	#12 Wire	1.94	100 jar
PT40BULK	16017	#12 Wire	19.60	1000 box
PT50*	16041	#12 Wire	1.96	100 box

\*The PT50 Stripped/#10 Fork.

OTHER SIZES AND QUANTITIES AVAILABLE BY REQUEST



Grounding  
Screw Attached

## GROUNDING PIGTAILS

WITH HEX WASHER "COMBO" SLOTTED/PHILLIPS  
DOG POINT • STEEL GREEN ZINC



PART#	UPC#	SIZE	WT. PER PKG.	STD. PKG. UM
<b>STRANDED COPPER INSULATED WIRE (With Fork And Ring Terminal)</b>				
PTS30	16001	#14 Wire	1.41	50 box
PTS30C	16032	#14 Wire	2.26	100 box
PTS40	16006	#12 Wire	1.88	50 box
PTS40C	16033	#12 Wire	2.82	100 box
PTS408*	16034	#12 Wire	28.20	1000 box

\*8 inch.

OTHER SIZES AND QUANTITIES AVAILABLE BY REQUEST



Grounding  
Screw Attached

7 INCH



Grounding  
Screw Attached

### GROUNDING PIGTAILS

WITH HEX WASHER "COMBO" SLOTTED/PHILLIPS  
DOG POINT • STEEL GREEN ZINC



PART#	UPC#	SIZE	WT. PER PKG.	STD. PKG. UM
<b>BARE SOLID COPPER WIRE IN A PLASTIC BOX</b>				
PT30B	16015	#14 Wire	1.42	100 box
PT40B	16010	#12 Wire	1.87	100 box

OTHER SIZES AND QUANTITIES AVAILABLE BY REQUEST

### GROUNDING PIGTAILS

WITH "QUADRIVE" HEX WASHER, SLOTTED/PHILLIPS,  
SQUARE DRIVE, DOG POINT • STEEL GREEN ZINC



The QuaDrive



7 INCH



Grounding  
Screw Attached

PART#	UPC#	SIZE	WT. PER PKG.	STD. PKG. UM
<b>SOLID COPPER INSULATED WIRE</b>				
PT35	16021	#14 Wire	1.62	100 box
PT45	16026	#12 Wire	2.06	100 box
PT45M	16028	#12 Wire	19.40	1000 box

OTHER SIZES AND QUANTITIES AVAILABLE BY REQUEST

8 INCH



### 8" GROUNDING PIGTAILS

- #12 Solid Copper Wire with Grounding Screw attached.
- 10-32 x 3/8 Hex Head Phillips/Slotted Dog Point Steel Green Zinc.



PART#	UPC#	LENGTH	SCREW DIAMETER	SCREW LENGTH	WT. PER PKG.	STD. PKG. UM
PT408	16008	8	10-32	3/8	2.30	100
PT408FS*	16158	8	10-32	3/8	1.88	100

\*PT408FS With Female Spade End.  
\*Denotes product not made in USA



10 INCH

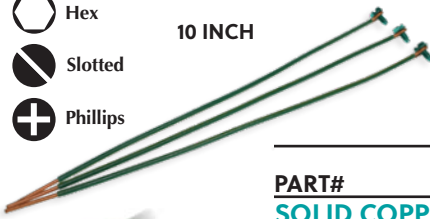

Grounding  
Screw Attached

### GROUNDING PIGTAILS

WITH HEX WASHER "COMBO" SLOTTED/PHILLIPS  
DOG POINT • STEEL GREEN ZINC

PART#	UPC#	SIZE	WT. PER PKG.	STD. PKG. UM
<b>SOLID COPPER INSULATED WIRE</b>				
PT4010	16007	#12 Wire	.62	25 bag
PT4010V	16092	#12 Wire	12.63	500 box

OTHER SIZES AND QUANTITIES AVAILABLE BY REQUEST

# SPECIAL PURPOSE ELECTRICAL FASTENERS

Wire  
**MADE IN USA**  
 Screws Assembled in USA

## GROUNDING PIGTAILS

WITH "QUADRIVE" HEX WASHER, SLOTTED/PHILLIPS, SQUARE DRIVE DOG POINT • STEEL GREEN ZINC



**12 INCH**  
QuaDrive  
Grounding Screw Attached

PART#	UPC#	SIZE	WT. PER PKG.	STD. PKG. UM
<b>SOLID COPPER INSULATED WIRE</b>				
<b>PT4012</b>	16012	#12 Wire	.72	25 bag
<b>PT4012V</b>	16094	#12 Wire	15.50	500 box

**OTHER SIZES AND QUANTITIES AVAILABLE BY REQUEST**

## 15" GROUNDING PIGTAILS

SOLID WIRE THREADED STUD ZINC

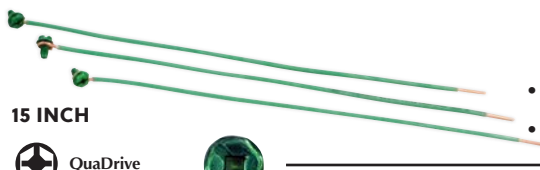

**15 INCH**  
QuaDrive  
Grounding Screw Attached

- Lead Point
- Steel Green Zinc
- Grounding Screw Attached
- "QuadDrive" Hex Washer, Slotted/Phillips

PART#	UPC#	WT. PER PKG.	STD. PKG. UM
<b>PT4015</b>	16018	.82	25

**MADE IN USA**  



## PAN HEAD TRI-DRIVE TELECOM CABINET SCREWS

STEEL ZINC • BLACK OXIDE

*For use in Telecom Cabinets, Relay Racks and Patch Panels*

**MADE IN USA**  

Tri-Drive

PART#	UPC#	DIAMETER	LENGTH	WT. PER PKG.	STD. PKG. UM
<b>STEEL ZINC</b>					
<b>JTEL1032</b>	84440	10-32	5/8	.64	100/500
<b>JTEL103234</b>	84442	10-32	3/4	.74	100/500
<b>TEL1224</b>	39096	12-24	5/8	.48	50/250
<b>JTEL1224</b>	84445	12-24	5/8	.48	50/250
<b>JTEL1228</b>	84450	12-28	5/8	.48	50/250
<b>BLACK OXIDE</b>					
<b>TEL1024BLK</b>	39250	10-24	5/8	.31	50
<b>JTEL1024BLK</b>	84444	10-24	5/8	.62	100/500
<b>TEL1032BLK</b>	39260	10-32	5/8	.33	50
<b>JTEL1032BLK</b>	84441	10-32	5/8	.64	100/500
<b>TEL1032BLKV</b>	39262	10-32	5/8	3.06	500
<b>TEL1224BLK</b>	39097	12-24	5/8	.48	50
<b>JTEL1224BLK</b>	84446	12-24	5/8	.85	100
<b>TEL1224BLKV</b>	39099	12-24	5/8	4.08	500

J=JAR PACKAGE – NO J=PLASTIC CLAMSHELL HANGING BOX  
**OTHER SIZES AND QUANTITIES AVAILABLE BY REQUEST**





### STRUT CLAMP

One Piece Strut Clamps For EMT/Rigid Conduit

- Galvanized Steel
- Soft wide saddle supports cable conduit & pipes
- No screws or bolts to drop
- Requires only a screwdriver or nutdriver for installation

PART#	UPC#	SIZE	EMT	RIGID	WT. PER	STD. PKG.
					PKG.	UM
1PSC38	19570	3/8	3/8	—	5.90	100
1PSC50	19571	1/2	1/2	—	6.00	100
1PSC75	19572	3/4 - 1/2	3/4	1/2	3.00	50
1PSC100	19573	1 - 3/4	1"	3/4	6.50	50
1PSC125	19574	1 1/4 - 1	1 1/4	1	9.25	50
1PSC150	19575	1 1/2 - 1 1/4	1 1/2	1 1/4	9.50	50
1PSC200	19576	2 - 1 1/2	2	1 1/2	7.50	25
1PSC200E	19577	2	2	—	7.50	25
1PSC250	19578	2 1/2 - 2 1/2	2 1/2	2 1/2	7.50	25
1PSC300	19579	3 - 3	3	3	3.00	25
1PSC350	19580	3 1/2 - 3 1/2	3 1/2	3 1/2	3.25	10
1PSC400	19581	4 - 4	4	4	3.50	10

OTHER SIZES AND QUANTITIES AVAILABLE BY REQUEST



### ONE HOLE RIGID PIPE STRAP

PART#	UPC#	SIZE	WT. PER	STD. PKG.
			PKG.	UM
50ROS	31911	1/2	6.00	100
75ROS	31912	3/4	8.00	100
100ROS	31913	1	11.00	100
125ROS	31914	1 1/4	9.00	50
150ROS	31915	1 1/2	20.02	50
200ROS	31916	2	8.75	25
250ROS	31917	2 1/2	12.75	25
300ROS	31918	3	16.50	25
350ROS	31919	3 1/2	23.00	25
400ROS	31920	4	26.00	25

OTHER SIZES AND QUANTITIES AVAILABLE BY REQUEST



### TWO HOLE RIGID PIPE STRAP

PART#	UPC#	SIZE	WT. PER	STD. PKG.
			PKG.	UM
50RTS	31923	1/2	2.00	100
75RTS	31924	3/4	2.60	100
100RTS	31925	1	4.60	100
125RTS	31926	1 1/4	2.75	50
150RTS	31927	1 1/2	6.00	50
200RTS	31928	2	3.75	25
250RTS	31929	2 1/2	4.13	25
300RTS	31930	3	5.70	25
350RTS	31931	3 1/2	6.50	25
400RTS	31932	4	8.15	25

OTHER SIZES AND QUANTITIES AVAILABLE BY REQUEST



# SPECIAL PURPOSE ELECTRICAL FASTENERS



## ONE HOLE EMT PIPE STRAP

PART#	UPC#	SIZE	WT. PER PKG.	STD. PKG. UM
50EOS	31887	½	2.37	100
75EOS	31888	¾	5.00	100
100EOS	31889	1	6.00	100
125EOS	31890	1¼	5.00	50
150EOS	31891	1½	6.36	50
200EOS	31892	2	5.11	25

OTHER SIZES AND QUANTITIES AVAILABLE BY REQUEST



## TWO HOLE EMT PIPE STRAP

PART#	UPC#	SIZE	WT. PER PKG.	STD. PKG. UM
50ETS	31893	½	1.00	100
75ETS	31894	¾	2.00	100
100ETS	31895	1	2.50	100
125ETS	31896	1¼	2.07	50
150ETS	31897	1½	3.50	50
200ETS	31898	2	2.56	25

OTHER SIZES AND QUANTITIES AVAILABLE BY REQUEST



## STEEL CONDUIT HANGERS PLATED WITH BOLTS AND NUTS

PART#	UPC#	EMT	RIGID	WT. PER PKG.	STD. PKG. UM
SCH50	31899	½"	½"	1.78	25
SCH75	31900	¾"	¾"	2.00	25
SCH100	31901	1"	1"	2.33	25
SCH125E	31902	1¼"	—	2.75	25
SCH125R	31903	—	1¼"	3.00	25
SCH150	31904	1½"	1½"	4.50	25
SCH200	31905	2"	2"	5.50	25
SCH250	31906	2½"	2½"	6.50	25
SCH300	31907	3"	3"	8.50	25
SCH350	31908	3½"	3½"	10.50	25
SCH400	31909	4"	—	22.50	25

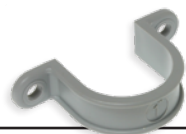

## PVC CONDUIT STRAPS FOR PVC ELECTRICAL CONDUIT

PART#	UPC#	CONDUIT SIZE	COLOR	WT. PER PKG.	STD. PKG. UM
PCS212	21815	½	Gray	.66	100
PCS234	21816	¾	Gray	.79	100
PCS244	21817	1	Gray	1.05	100
PCS254	21818	1¼	Gray	.73	50
PCS264	21819	1½	Gray	.95	50
PCS274	21821	2	Gray	1.40	50
PCS284	21823	2½	Gray	.29	5
PCS294	21825	3	Gray	.34	5
PCS204	21829	4	Gray	.44	5

OTHER SIZES AND QUANTITIES AVAILABLE BY REQUEST





**CAGE NUTS**  
STEEL BLACK PHOSPHATE

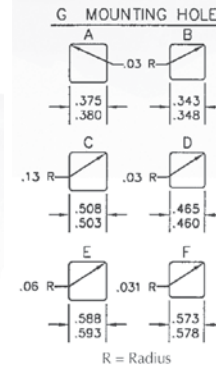
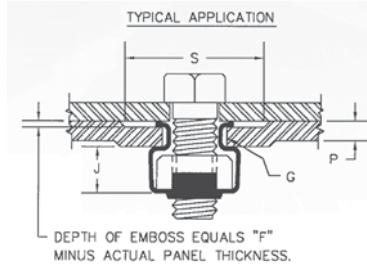
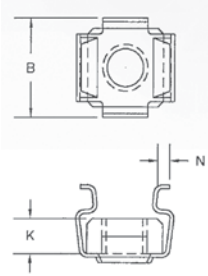

PART#	SCREW SIZE	PANEL RANGE P	F	S	MNTG. HOLE G	B	J	N	K
CNN1024	10-24	.025 - .063	0.1	0.531	A or B	0.52	0.06	0.6	0.156
CNN1032	10-32	.025 - .063	0.1	0.531	A or B	0.52	0.06	0.6	0.156
CNN1032M	10-32	.025 - .063	0.1	0.531	A or B	0.52	0.06	0.6	0.156
CNN1224	12-24	.025 - .063	0.1	0.531	A or B	0.52	0.06	0.6	0.156

PART#	UPC#	CAGE NUT SIZE	PANEL RANGE	MOUNTING HOLE	COATING	WT. PER PKG.	STD. PKG. UM
CNN1024	30030	10-24	.025 - .063	.343 - .348 or .375 - .380	Black Phosphate	.63	50
CNN1032	30025	10-32	.025 - .063	.343 - .348 or .375 - .380	Black Phosphate	.54	50
CNN1032M	85592	10-32	.025 - .063	.343 - .348 or .375 - .380	Black Phosphate	11.26	1000
CNN1224	30035	12-24	.025 - .063	.343 - .348 or .375 - .380	Black Phosphate	.60	50

OTHER SIZES AND QUANTITIES AVAILABLE BY REQUEST – SOME SIZES AVAILABLE IN STAINLESS STEEL



**CAGE NUT KITS**

STEEL BLACK PHOSPHATE

For use in telecom cabinets, relay racks and patch panels

PART#	UPC#	CAGE NUT SIZE	PANEL RANGE	MOUNTING HOLE	SCREW DIAMETER	SCREW LENGTH	WT. PER PKG.	STD. PKG. UM
CNN1024K	85585	10-24	.025 - .063	.343 - .348 or .375 - .380	10-24	5/8	.96	1
CNN1032K	85590	10-32	.025 - .063	.343 - .348 or .375 - .380	10-32	5/8	.80	1
CNN1224K	85595	12-24	.025 - .063	.343 - .348 or .375 - .380	12-24	5/8	.96	1

OTHER SIZES AND QUANTITIES AVAILABLE BY REQUEST

**OVAL HEAD SLOTTED WALL PLATE SCREWS**

STEEL ZINC • 18-8 STAINLESS

Plated and painted. Packaged in visual plastic hanging box

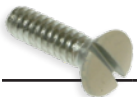

PART#	UPC#	SIZE	LENGTH	COLOR	WT. PER PKG.	STD. PKG. UM
<b>STEEL ZINC</b>						
SP382	10323	6-32	7/32	Brown	.21	100/500
SP379	10320	6-32	7/32	White	.21	100/500
SP175	16306	6-32	1/2	Antique Copper	.27	100/500
SP176	16305	6-32	1/2	Brass Plate	.26	100/500
SP177	16310	6-32	1/2	Nickel Plate	.29	100/500
SP178	16315	6-32	1/2	Antique Black	.26	100/500
SP178B	16316	6-32	1/2	Antique Black	2.07	1000
SP179	16320	6-32	1/2	White	.28	100/500
SP180	16325	6-32	1/2	Ivory	.29	100/500
SP173	16300	6-32	1/2	Almond	.30	100/500
SP181	16330	6-32	1/2	Gray	.28	100/500

\*Jar Package – OTHER SIZES AND QUANTITIES AVAILABLE BY REQUEST

# SPECIAL PURPOSE ELECTRICAL FASTENERS

CONTINUED

## OVAL HEAD SLOTTED WALL PLATE SCREWS

STEEL ZINC • 18-8 STAINLESS

Plated and painted. Packaged in visual plastic hanging box



PART#	UPC#	SIZE	LENGTH	COLOR	WT. PER PKG.	STD. PKG. UM
<b>STEEL ZINC</b>						
SP182	16335	6-32	¾	Brown	.28	100/500
SP190	16303	6-32	¾	White	.35	100/500
SP191	16304	6-32	¾	Ivory	.36	100/500
SP279	16301	6-32	1	White	.43	100/500
SP280	16302	6-32	1	Ivory	.43	100/500
SP184	16338	6-32	1	Black	.43	100/500
SP281*	16411	6-32	2	Ivory	.72	100/500
SP282*	16412	6-32	2	White	.72	100/500
SP285*	16313	6-32	2	Steel	.72	100/500
SP286*	16314	8-32	2	Steel	.72	100/500
<b>18-8 STAINLESS</b>						
SP170	16406	6-32	½	Stainless Steel	.29	100/500
SP170W	16407	6-32	½	White	.29	100/500
SP283	16413	6-32	1	Stainless Steel	.40	100/500
SP172	16307	6-32	1-¼	Stainless Steel	.44	100/500
SP284	16312	6-32	1-½	Stainless Steel	.49	100/500

\*Jar Package – OTHER SIZES AND QUANTITIES AVAILABLE BY REQUEST

## SWITCH PLATE SCREW KITS

A convenient assortment of switch plate screws in the most popular colors and finishes plated and painted

**275 Piece Renovation Kit Spk100 Contains:** 50 6-32 X ½ Black, 50 Nickel, 50 Almond, 50 Ivory, 50 White, 25 6-32 X 1-¼ Flat Head Slot Switch Plate Screw, Zinc Plated

**Spk101 – 500 Piece New Construction Spk101 Contains:** 100 Each 6-32 X ½ Ivory, White, Stainless, 75 Each 6-32 X 1 Ivory, White, 50 6-32 X 1-¼ Flat Head Slot Switch Plate Screw, Zinc Plated

**Spk102 – 600 Piece New Construction Spk102 Contains:** 100 Each 6-32 X 7/32, 6-32 X ½, 6-32 X ¾, 6-32 X 1, 6-32 X 1-¼, 6-32 X 2 Ivory, White, Stainless, 75 Each 6-32 X 1 Ivory, White, 50 6-32 X 1-¼ Flat Head Slot Switch Plate Screw, Zinc Plated



PART#	UPC#	DIAMETER	LENGTH	STYLE	WT. PER PKG.
SPK100	16400	6-32	½, 1-¼	Oval Head	1.84
<b>RENOVATION</b>					
SPK101	16401	6-32	½, 1, 1-¼	Oval Head	1.60
<b>NEW CONSTRUCTION</b>					
SPK102	16402	6-32	7/32, ½, ¾, 1, 1-¼, 2	Oval Head	1.89
<b>NEW CONSTRUCTION</b>					

OTHER SIZES AND QUANTITIES AVAILABLE BY REQUEST



### UNDERCUT OVAL HEAD SLOTTED DECORATIVE SWITCH PLATE SCREWS

STEEL ZINC – PAINTED

For wall plates not accepting standard 1/2" switch plate screws

PART#	UPC#	SIZE	LENGTH	COLOR	WT. PER PKG.	STD. PKG. UM
SPD379	16321	6-32	1/4	White	.14	50
SPD380	16326	6-32	1/4	Ivory	.14	50
SPD382	16336	6-32	1/4	Almond	.14	50
SPD383	16341	6-32	1/4	Gray	.14	50
SPD381	16327	6-32	1/4	Brown	.14	50
SPD384	16342	6-32	1	White	.25	50
SPD385	16343	6-32	1	Ivory	.26	50

OTHER SIZES AND QUANTITIES AVAILABLE BY REQUEST

### UNDERCUT OVAL HEAD SLOTTED DECORATIVE SWITCH PLATE SCREW KIT

STEEL ZINC – PAINTED



A convenient assortment of popular colors for wall plates not accepting standard 1/2" switch plate screws

**250 PIECE SPDK200 KIT CONTAINS:**

6-32 X 1/4 - 50 White, 50 Ivory, 50 Almond, 50 Gray  
PLUS 6-32 x 1 - 25 White, 25 Ivory

PART#	UPC#	DIAMETER	LENGTH	STYLE	WT. PER PKG.	STD. PKG. UM
SPDK200	16405	6-32	1/4 & 1	Assorted Steel Slotted, Undercut, Oval Head Switch Plate Screws	.68	1/25 kits

OTHER SIZES AND QUANTITIES AVAILABLE BY REQUEST

### QUICK FIX GB® SPACERS

POLYETHYLENE

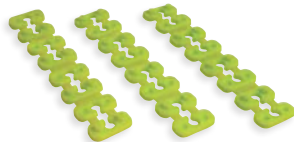
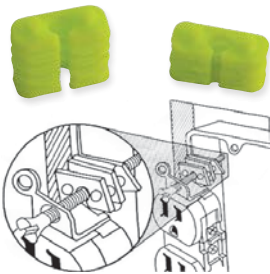

- Stackable spacers for wiring devices
- Fill gaps and bring devices flush with surface
- Supports devices securely to wallbox
- Prevents broken faceplates
- Green color disassociates any notion of an earth-ground connection

PART#	UPC#	WT. PER PKG.	STD. PKG. UM
SLSP50	71666	.38	50



We believe Metallics has the largest ratio of American made to foreign produced product of any other American fastener company.



# SPECIAL PURPOSE ELECTRICAL FASTENERS

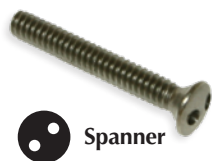

## TAMPER-RESIST SPANNER OVAL/PAN HEAD SWITCH PLATE SCREWS 18-8 STAINLESS



PART#	UPC#	DIAMETER	LENGTH	WT. PER PKG.	STD. PKG. UM
SPT201	10279	6-32	¼	.17	50
SPT200	16355	6-32	½	.19	50
SPT300	10270	6-32	1	.27	50
SPT400	10275	6-32	1-½	.35	50
SPT812	16362	8-32	1-¼	.68	50
SPT820*	16367	10-24	¾	.64	100
<b>WHITE</b>					
SPT200W	16354	6-32	½	.38	100

\*PAN HEAD.

COMES COMPLETE WITH 00SP6B SPANNER INSERT DRIVER. **OTHER SIZES AND QUANTITIES AVAILABLE BY REQUEST**



## INSULATING FOAM GASKETS

- Energy saving gaskets prevent heat and cold loss through outlets and switches located on outside walls.
- Constructed of UL Rated, close-cell polyethylene insulating foam.
- Available in three different designs: Toggle Switch, Duplex Receptacle & GFI or Decora



PART#	UPC#	ITEM	WT. PER EACH	STD. PKG. UM
WGT25	71651	Toggle Switch	.14	25
WGR25	71652	Duplex Receptacle	.14	25
WGD25	71653	GFI/Decora	.14	25
WGT100	71654	Toggle Switch	.48	100
WGR100	71655	Duplex Receptacle	.48	100
WGD100	71656	GFI/Decora	.48	100
WGC100*	71657	Combo Pack	.48	100

\*CONTAINS: 30 TOGGLE, 30 DUPLEX, 40 DECORA – **OTHER SIZES AND QUANTITIES AVAILABLE BY REQUEST**



## CONDUIT DRIVE STRAPS

STEEL ZINC ROUND TYPE



PART#	UPC#	SIZE EMT	SIZE PIPE & FLEX. COND.	SIZE OVERALL LENGTH	WT. PER PKG.	STD. PKG. UM
For use in metal and plastic conduit and tubing						
CDS1	21200	¾ - ½	¾	2	1.93	100
CDS2	21205	¾	½	2-¼	2.23	100
CDS3	21210	1	¾	2-¼	2.37	100

**OTHER SIZES AND QUANTITIES AVAILABLE BY REQUEST**



## CONDUIT DRIVE STRAPS

STEEL COPPER PLATED ROUND TYPE



PART#	UPC#	SIZE COPPER TUBE	SIZE COPPER PIPE	SIZE OVERALL LENGTH	WT. PER PKG.	STD. PKG. UM
For use in areas requiring copper pipe and tubing						
CDS5	21300	½	¾ - ½	2	1.87	100
CDS6	21305	¾	¾	2-¼	2.50	100

**OTHER SIZES AND QUANTITIES AVAILABLE BY REQUEST**



## CONDUIT DRIVE STRAPS

STAMPED GALVANIZED



PART#	UPC#	SIZE COPPER PIPE	SIZE	WT. PER PKG.	STD. PKG. UM
SDS10	21215	$\frac{3}{8}$ - $\frac{1}{2}$	$\frac{3}{8}$	1.70	100
SDS20	21220	$\frac{3}{4}$	$\frac{1}{2}$	2.13	100
SDS30	21225	1	$\frac{3}{4}$	2.29	100

OTHER SIZES AND QUANTITIES AVAILABLE BY REQUEST



## PLUMBERS TAPE PERFORATED

STEEL GALVANIZED

PART#	UPC#	GAUGE	WIDTH	WT. PER PKG.	STD. PKG. UM
HR750	22550	20	$\frac{3}{4}$	7.80	10 rolls of 10'/per pkg
HR770	22553	24	$\frac{3}{4}$	4.31	10 rolls of 10'/per pkg
HR780	22554	28	$\frac{3}{4}$	4.32	10 rolls of 10'/per pkg

COPPER AVAILABLE UPON REQUEST - OTHER SIZES AND QUANTITIES AVAILABLE BY REQUEST



## NAIL PLATES

STEEL

For Romex, BX, UF, S.E.V. and other Cables

PART#	UPC#	LENGTH	WIDTH	GAUGE	WT. PER PKG.	STD. PKG. UM
*NP400	16500	2 $\frac{3}{4}$	1 $\frac{1}{2}$	16	6.23	100
*NP400B	16515	2 $\frac{3}{4}$	1 $\frac{1}{2}$	16	33.90	500
*NP401	16517	3	1 $\frac{1}{2}$	18	15.00	250
*NP660	16599	5	1 $\frac{1}{2}$	16	7.00	100
*NP600	16503	5	1 $\frac{1}{2}$	20	7.69	100
*NP800	16504	5	3	16	24.25	100

\*DIMENSIONS ON ALL NAIL PLATES/STRAPS ARE APPROXIMATE - OTHER SIZES, GAUGES AND QUANTITIES AVAILABLE BY REQUEST



## PLATE STRAPS

STEEL

PART#	UPC#	WIDTH	LENGTH	HOLE	GAUGE	WT. PER PKG.	STD. PKG. UM
*NPL12	12194	1 $\frac{1}{2}$	12	8	18	24.19	50
*NS1812	22548	1 $\frac{1}{2}$	18	8	12	16.15	25
*NS1816	22549	1 $\frac{1}{2}$	18	8	16	45.45	100
*NS2412	22565	1 $\frac{1}{2}$	24	8	12	21.00	25
*NS2416	22567	1 $\frac{1}{2}$	24	8	16	27.00	50
*NS2418	22568	1 $\frac{1}{2}$	24	8	18	21.00	50
*NP580	16520	5	8	6	16	32.00	50
*NPL188	16480	5	18	5	16	39.19	25

\*DIMENSIONS ON ALL NAIL PLATES/STRAPS ARE APPROXIMATE - OTHER SIZES, GAUGES AND QUANTITIES AVAILABLE BY REQUEST



## BOX SUPPORTS

STEEL • ELECTRO-GALVANIZED



PART#	UPC#	WT. PER PKG.	STD. PKG. UM
SB300	16200	5.29	100 pairs/200 pieces total
SBL300	15577	6.00	100 pairs/200 pieces total

OTHER SIZES AND QUANTITIES AVAILABLE BY REQUEST



# SPECIAL PURPOSE ELECTRICAL FASTENERS

## GALVANIZED NAIL-ON DRIVE RINGS

STEEL ZINC



PART#	UPC#	EYE SIZE	WT. PER PKG.	STD. PKG. UM
MDR12	81549	1/2	.14	10
MDR58	81551	5/8	.14	10
MDR78	81553	7/8	.53	10
MDR114	81555	1 1/4	.78	10

OTHER SIZES AND QUANTITIES AVAILABLE BY REQUEST

## ANTI-SHORT BUSHINGS



PART#	UPC#	TRADE SIZE NM	WT. PER PKG.	STD. PKG. UM
ASB0	31940	5/16	4.00	35
ASB1	31941	3/8	4.00	35
ASB2	31942	7/16	4.00	35
ASB3	31943	1/2	4.00	20
ASB4	31944	3/4	4.64	16
ASB5	31945	1	6.24	16
ASB6	31946	1 1/4	4.60	10
ASB7	31947	1 1/2	10.40	10
ASB8	31948	2 to 2 1/2	14.90	10

## INSULATED BUSHINGS



- Plastic for rigid conduit
- Prevent wires from being damaged as they pass through the end of the conduit.
- Provide smoothly rounded surfaces at the end of raceways.
- Easily screws on to threaded conduits.



PART#	UPC#	SIZE	WT. PER PKG.	STD. PKG. UM
IPB50	99941	1/2	.38	50
IPB75	99940	3/4	.50	50
IPB100	99939	1	.75	50
IPB125	99938	1 1/4	1.00	50
IPB150	99937	1 1/2	1.50	50
IPB200	99936	2	2.00	50
IPB250	99935	2 1/2	3.50	50
IPB300	99934	3	2.50	25
IPB350	99933	3 1/2	3.00	25
IPB400	99932	4	3.75	25
IPB500	99931	5	2.80	10
IPB600	99930	6	3.40	10



## SNAP IN KNOCK OUT SEALS



PART#	UPC#	SIZE	WT. PER PKG.	STD. PKG. UM
50SNKO	41668	1/2	.16	10
75SNKO	41669	3/4	.20	10
100SNKO	41664	1	.27	10
125SNKO	41665	1 1/4	.38	10
150SNKO	41666	1 1/2	.46	10
200SNKO	41667	2	.64	10

OTHER SIZES AND QUANTITIES AVAILABLE BY REQUEST



100KOS

Size Is Stamped On Seal

### KNOCK-OUT SEALS

STEEL ZINC

The ultimate in high quality safety

3-Piece Quick-Seal to plug holes in panel boxes



150KOSG

PART#	UPC#	SIZE	PC. K/O SEAL	WT. PER PKG.	STD. PKG. UM
50KOS	41301	½	3	.25	10
75KOS	41302	¾	3	.33	10
100KOS	41303	1	3	.47	10
125KOS	41304	1¼	3	.74	10
150KOS	41306	1½	3	.95	10
200KOS	41307	2	3	1.38	10
250KOS	41308	2½	3	2.10	10
300KOS	41309	3	3	1.50	5
350KOS	41311	3½	3	1.93	5
400KOS	41312	4	3	2.74	5
<b>GASKETED</b>					
50KOSG	41650	½	4	.30	10
75KOSG	41651	¾	4	.36	10
100KOSG	41652	1	4	.45	10
125KOSG	41653	1¼	4	.78	10
150KOSG	41654	1½	4	1.02	10
200KOSG	41655	2	4	1.62	10
250KOSG	41658	2½	4	2.10	10
300KOSG	41660	3	4	1.74	5
350KOSG	41314	3½	4	2.19	5
400KOSG	41317	4	4	2.94	5

OTHER SIZES AND QUANTITIES AVAILABLE BY REQUEST



### SLOTTED JUNCTION BOX PLUGS

PART#	UPC#	SIZE	WT. PER PKG.	STD. PKG. UM
PP50	31882	½	.50	25
PP75	31883	¾	.75	25
PP100	31884	1	1.00	25



MN20D50

### BRIGHT COMMON NAILS

STEEL

20D And 30D Packaged In 50 Lb. Cartons



MN30D50

PART#	UPC#	SIZE	WT. PER PKG.	STD. PKG. UM
MN20D50	21320	20D	50.00	1100
MN30D50	21330	30D	50.00	1450



### BRIGHT COMMON NAILS

STEEL

For all types of rough-in wood construction

PART#	UPC#	SIZE	WT. PER PKG.	APPROX. COUNT	STD. PKG. UM
MN8C	21226	8D	2.63	220	1 Jar
MN10C	21227	10D	2.63	170	1 Jar
MN12C	21340	12D	2.53	158	1 Jar
MN16C	21228	16D	2.64	115	1 Jar

OTHER SIZES AND QUANTITIES AVAILABLE BY REQUEST

# SPECIAL PURPOSE ELECTRICAL FASTENERS



## BRIGHT FINISH NAILS

STEEL

For interior and exterior wood finishes

PART#	UPC#	SIZE	WT. PER PKG.	APPROX. COUNT	STD. PKG. UM
MN4F	21229	4D	2.61	1350	1 Jar
MN6F	21230	6D	2.62	1390	1 Jar

OTHER SIZES AND QUANTITIES AVAILABLE BY REQUEST



## HOT GALVANIZED BOX NAILS

STEEL

For exterior areas affected by water and humidity

PART#	UPC#	SIZE	WT. PER PKG.	APPROX. COUNT	STD. PKG. UM
MN6HG	21231	6D	2.62	450	1 Jar
MN7HGB	21325	7D	50.00	8565	1 Box
MN8HG	21232	8D	2.63	290	1 Jar
MN10HG	21233	10D	2.66	190	1 Jar
MN16HG	21234	16D	2.64	135	1 Jar

OTHER SIZES AND QUANTITIES AVAILABLE BY REQUEST



## GALVANIZED ROOFING BOX NAILS

STEEL

PART#	UPC#	SIZE	WT. PER PKG.	APPROX. COUNT	STD. PKG. UM
MN112HGJST	21253	1½	50.00	6250	50 lb box
MN112R	21247	1½	5.32	970	5 lb box
MN112R25	21248	1½	2.66	485	2.5 lb box

OTHER SIZES AND QUANTITIES AVAILABLE BY REQUEST



## BRIGHT DUPLEX NAILS

STEEL

For temporary wood structure  
Double head allows for ease of extraction and disassembly

PART#	JAR UPC#	SIZE	WT. PER PKG.	APPROX. COUNT	STD. PKG. UM
MN8DP	21238	8D	2.61	200	1 Jar
MN16DP	21239	16D	2.63	105	1 Jar

OTHER SIZES AND QUANTITIES AVAILABLE UPON REQUEST



## BRIGHT JOIST HANGER NAILS

STEEL

For all types of light brackets, straps in wood joists

PART#	JAR UPC#	SIZE	WT. PER PKG.	APPROX. COUNT	STD. PKG. UM
MN114J	21240	1¼ - 9 GA	2.59	360	1 Jar
MN112J	21241	1½ - 9 GA	2.60	300	1 Jar

OTHER SIZES AND QUANTITIES AVAILABLE UPON REQUEST



Coating allows faster penetration

## COATED SINKER NAILS

STEEL

For all types of rough-in wood construction

PART#	JAR UPC#	SIZE	WT. PER PKG.	APPROX. COUNT	STD. PKG. UM
MN8S	21235	8D	2.63	340	1 Jar
MN10S	21236	10D	2.57	240	1 Jar
MN16S	21237	16D	2.67	140	1 Jar
MN16S50B	21297	16D	50.00	2600	50 lb Box
MN16SP	21285	16D	10.00	520	10 lb Pail

OTHER SIZES AND QUANTITIES AVAILABLE BY REQUEST





CONTRACTOR NAIL APRON

PART#	UPC#	POCKETS	WT. PER PKG.	STD. PKG. UM
NAP1	71740	2	.22	1

HEAT TEMPERED FLUTED MASONRY NAILS

STEEL



Nails designed to penetrate concrete and other masonry products

PART#	JAR UPC#	SIZE	WT. PER PKG.	APPROX. COUNT	STD. PKG. UM
MN1TM	21242	1	2.60	370	1 Jar
MN112TM	21243	1-½	2.55	225	1 Jar
MN2TM	21244	2	2.64	180	1 Jar
MN212TM	21245	2-½	2.63	168	1 Jar
MN3TM	21246	3	2.62	135	1 Jar

OTHER SIZES AND QUANTITIES AVAILABLE UPON REQUEST

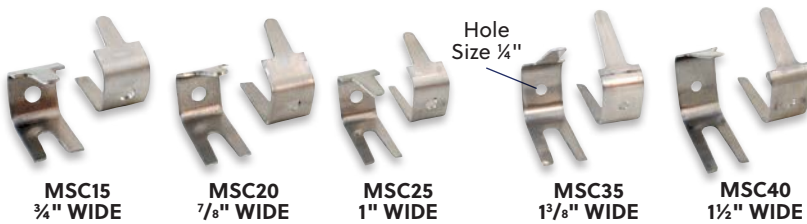

FOLD OVER STRAPS  
ALUMINUM

PART#	UPC#	DESCRIPTION	WT. PER PKG.	STD. PKG. UM
MSC15	53379	Aluminum ¼" Hole Size - Strap Cable Size 8/3 + 6/3	1.2	100
MSC20	53380	Aluminum ¼" Hole Size - Strap Cable Size 24/3	1.3	100
MSC25	53381	Aluminum ¼" Hole Size - Strap Cable Size 2/3	1.7	50
MSC35	53382	Aluminum ¼" Hole Size - Strap Cable Size 2/0	1.5	25
MSC40	53383	Aluminum ¼" Hole Size - Strap Cable Size 4/0	1.5	25



EZ STAPLES

Easy to handle, get into tight spaces and reduce drops



PART#	UPC#	SIZE	WT. PER PKG.	STD. PKG. UM
EZSTPL1C	85245	½ x 1	.59	100 jar
EZSTPL5C	85250	½ x 1	2.76	500 pail
EZSTPL2M	85255	½ x 1	11.12	2000 pail

OTHER SIZES AND QUANTITIES AVAILABLE UPON REQUEST

# SPECIAL PURPOSE ELECTRICAL FASTENERS

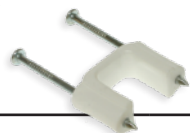

## STACKING STAPLES

PLASTIC

MADE IN USA



PART#	UPC#	CABLE SIZE	WT. PER PKG.	STD. PKG. UM
SCT6215	21755	For stacking two 2-wire #14 or #12 NM cable	.39	50
SCT6215C	21785	For stacking two 2-wire #14 or #12 NM cable	.87	100
SCT6215V	21786	For stacking two 2-wire #14 or #12 NM cable	4.06	500
SCT6315	21760	For stacking three 2-wire or a 2-wire & 3-wire #14 or #12 NM cable	.46	50
SCT6315C	21783	For stacking three 2-wire or a 2-wire & 3-wire #14 or #12 NM cable	.99	100
SCT6315V	21784	For stacking three 2-wire or a 2-wire & 3-wire #14 or #12 NM cable	4.42	500
SCT6415	21765	For stacking two 3-wire or four 2-wire #14 or #12 NM cable	.46	50
SCT6415C	21788	For stacking two 3-wire or four 2-wire #14 or #12 NM cable	1.08	100
SCT6415V	21787	For stacking two 3-wire or four 2-wire #14 or #12 NM cable	4.85	500

OTHER SIZES AND QUANTITIES AVAILABLE BY REQUEST



## SERVICE ENTRANCE STAPLES

PLASTIC

MADE IN USA



PART#	UPC#	CABLE SIZE	COLOR	WT. PER PKG.	STD. PKG. UM
SES4115	21770	#6 type SER	Gray	.63	50
SES4215	21771	#6 type SEU	Gray	.60	50
SES4312	21775	#2 type SER	Gray	.45	25
SES4412	21776	#2 type SEU	Gray	.33	25
SES4512	21781	4/0 type SEU	Gray	.51	25
SES4612	21780	4/0 type SER	Gray	.67	25

OTHER SIZES AND QUANTITIES AVAILABLE BY REQUEST



1" L x ½" W



1¼" L x ⅞" W

## NON-INSULATED CABLE STAPLES

302 STAINLESS

PART#	UPC#	DIMENSIONS	WT. PER PKG.	STD. PKG. UM
JCST40SS	20984	1 L x ½ W	.61	100 jar
FST40SS	20985	1 L x ½ W	2.89	500 box
KST40SS	20986	1 L x ½ W	28.90	5000 box
JCST100SS	20987	1¼ L x ⅞ W	.62	100 jar
FST100SS	20988	1¼ L x ⅞ W	2.96	500 box
KST100SS	20989	1¼ L x ⅞ W	29.60	5000 box



**NON-INSULATED  
CABLE STAPLES**  
STEEL

C = 100 PCS PER BOX

F = 500 PCS PER JAR

P = 5,000 PCS PER PAIL

EXAMPLE: CST40 = 100 PCS FST40 = 500 PCS

PST40 = 5,000 PCS



PART#	UPC#	USE	LENGTH	WIDTH	WT. PER PKG.	STD. PKG. UM
CST40	21000	N.M.C. 2 Romex #12 & #14	1	1/2	.60	100/box
JCST40	84970				.61	100/jar
FST40	21005				2.89	500/jar
PST40	21007				26.95	5000/pail
CST100	21010	N.M.C. & Armored #14, #12, #10 w/gr	1 1/4	9/16 W RX & BX	.73	100/box
JCST100	84980				.62	100/jar
FST100	21015				3.88	500/jar
PST100	21017				35.90	5000/pail
<b>N.M.C. - TO BE USED ON NON-METALLIC CABLE</b>						
CST300	21020	Service Entrance SEU3 #6	1 3/8	1 3/16	1.18	100/box
FST300	21022				6.26	500/jar
CST350	21025	Service Entrance SEU2 #6	1 1/2	1 1/16	1.31	100/box
FST350	21027				For 2 #3 Full 10 Ga. Wire	6.41
M151	23565	4/0 SER Cable Steel	2 1/2	1 7/8	3.81	100

OTHER SIZES AND QUANTITIES AVAILABLE BY REQUEST

**INSULATED CABLE STAPLES**

STEEL/PLASTIC

For better cable protection!



CST40I



PART#	UPC#	WIRE SIZE	SIZE	WT. PER PKG.	STD. PKG. UM
CST40I	21030	#12, #14	1 x 1/2	.59	100 box
JCST40I	85374	#12, #14	1 x 1/2	.54	100 jar
CST100I	21018	#10, #12, #14	1 1/4 x 9/16	.71	100 box
JCST100I	85378	#10, #12, #14	1 1/4 x 9/16	.71	100 jar
CST350P	21093	#10, #12, #14	1 1/4 x 9/16	27.25	500 pail
CST100P	29006	#10, #12, #14	1 1/4 x 9/16	13.35	1500 pail
FST100I	21019	#10, #12, #14	1 1/4 x 9/16	3.50	250 jar
PST100I	21021	#10, #12, #14	1 1/4 x 9/16	37.00	5000 pail
FST40I	21035	#10, #12, #14	1 x 1/2	2.74	500 jar
PST40I	21040	#10, #12, #14	1 x 1/2	28.98	5000 pail

OTHER SIZES AND QUANTITIES AVAILABLE BY REQUEST

WHILE SUPPLIES LAST!



JIST18W-1/8 x 11/16



JIST18B-1/8 x 11/16

**INSULATED STAPLES**

For Low Voltage Wiring



JIST6-1/4 x 3/4



JIST7-1/4 x 7/8

PART#	UPC#	WIDTH	LENGTH OF LEGS	WT. PER PKG.	STD. PKG. UM
JIST18W	81047	1/8	11/16	.23	100
JIST18B	81049	1/8	11/16	.23	100

JIST6 & JIST7 WHILE SUPPLIES LAST – Call for More Information.

OTHER SIZES AND QUANTITIES AVAILABLE BY REQUEST



# SPECIAL PURPOSE ELECTRICAL FASTENERS



## DATA COMM. STAPLES .190 DIAMETER PLASTIC



PART#	UPC#	SIZE	WT. PER PKG.	STD. PKG. UM
DCS1	21938	.190	.23	100
DCS1V	21939	.190	1.15	500

OTHER SIZES AND QUANTITIES AVAILABLE BY REQUEST



## WHITE INSULATED TWO NAIL STAPLES PLASTIC



PART#	UPC#	SIZE	WT. PER PKG.	STD. PKG. UM
CS50	21914	1/2	.45	100
CS50V	21917	1/2	2.25	500
CS50P	21916	1/2	9.98	2000
CS75	21918	3/4	.48	100
CS75P	21920	3/4	8.05	1500

1/2 secures 14-2 or 12-2 with ground non-metallic cable and other non-metallic cable 1/2 wide

3/4 secures 12-3 or 10-3 with ground non-metallic cable and other non-metallic cable 3/4 wide

OTHER SIZES AND QUANTITIES AVAILABLE BY REQUEST



## CABLE STAPLES PLASTIC



PART#	UPC#	CABLE SIZE	WT. PER PKG.	STD. PKG. UM
PCS125	21790	2 & 3 wire NM cable up to #12 2-wire UF cable up to #12 & other cable up to 1/2 wide	.45	100
PCS125V	21791	2 & 3 wire NM cable up to #12 2-wire UF cable up to #12 & other cable up to 1/2 wide	.45	500
PCS345	21795	2 wire NM cable up to #8 3-wire UF cable up to #12 & other cable up to 3/4 wide	.47	100

OTHER SIZES AND QUANTITIES AVAILABLE BY REQUEST



## SMALL WIRE STAPLES PLASTIC



PART#	UPC#	CABLE SIZE	WT. PER PKG.	STD. PKG. UM
SPS5151	21810	1/4 x 1/8	.20	100

OTHER SIZES AND QUANTITIES AVAILABLE BY REQUEST



## CO-AXIAL STAPLES PLASTIC



PART#	UPC#	WIDTH	WT. PER PKG.	STD. PKG. UM
CAS5051	21800	1/4	.20	100

OTHER SIZES AND QUANTITIES AVAILABLE BY REQUEST



**INSULATED(1000V) SCREWDRIVER SET**

4 PIECE

- **Patented Dual Layer** design provides greater protection against electric shock.
- **Dual Material PP & TPV** cushion grip provides slip resistance to chemical, oil and most solvents.

PART#	UPC#	SIZES	HEAD STYLE	WT. PER PKG.	STD. PKG. UM
ISK4	16281	¼" x 6"	Slotted	1.15	1
		5/16" x 7"	Slotted		
		No. 1 x 3 <sup>3</sup> / <sub>16</sub> "	Phillips		
		No. 2 x 4"	Phillips		



**¼ DRIVE STANDARD/METRIC SOCKET MASTER SET**

48 PIECE

PART#	UPC#	SIZES	WT. PER PKG.	STD. PKG. UM	
MSOC14	16274	<b>STANDARD</b>		2.69	1
		¼ Drive SAE 6 Point Standard Socket 5/32			
		¼ Drive SAE 6 Point Standard Socket 3/16			
		¼ Drive SAE 6 Point Standard Socket 7/32			
		¼ Drive SAE 6 Point Standard Socket ¼			
		¼ Drive SAE 6 Point Standard Socket 9/32			
		¼ Drive SAE 6 Point Standard Socket 5/16			
		¼ Drive SAE 6 Point Standard Socket 11/32			
		¼ Drive SAE 6 Point Standard Socket 3/8			
		¼ Drive SAE 6 Point Standard Socket 7/16			
		¼ Drive SAE 6 Point Standard Socket ½			
		¼ Drive SAE 6 Point Standard Socket 9/16			
		<b>METRIC</b>			
		¼ Drive Metric 6 Point Standard Socket 4mm			
		¼ Drive Metric 6 Point Standard Socket 4.5mm			
		¼ Drive Metric 6 Point Standard Socket 5mm			
		¼ Drive Metric 6 Point Standard Socket 5.5mm			
		¼ Drive Metric 6 Point Standard Socket 6mm			
		¼ Drive Metric 6 Point Standard Socket 7mm			
		¼ Drive Metric 6 Point Standard Socket 8mm			
		¼ Drive Metric 6 Point Standard Socket 9mm			
		¼ Drive Metric 6 Point Standard Socket 10mm			
		¼ Drive Metric 6 Point Standard Socket 11mm			
		¼ Drive Metric 6 Point Standard Socket 12mm			
		¼ Drive Metric 6 Point Standard Socket 13mm			
		¼ Drive Pear Ratchet Handle 72 Teeth 4.5			
		¼ Drive Extension Bar 2			
		¼ Drive Extension Bar 6			
		¼ Drive Universal Joint			
		Bits Set 1: T10, T15, T20, T25, T27, T30, T40, PH1, PH2, PH3			
Bits Set 2: 3/16, 7/32, ¼, S1, S2, H3, H4, H5, H6 Hex Adapter					
Ratcheting Screwdriver					

## 32 PC. SCREWDRIVER BIT SET



### Slim and Compact Design Convenient Clip

- Industrial quality
- RC. Hardness 58-62
- Snap locking case
- Great for the job, home or garage

PART#	UPC#	SIZES/ITEMS	WT. PER PKG.	STD. PKG. UM
MTECH32	19819	Phillips: #0, #1, #2 (2), #3, #2DW (2)	.70	1
		Slotted: 6-8, 8-10, 10-12		
		Square: #0, #1, #2 (3), #3		
		Hex: $\frac{5}{64}$ , $\frac{3}{32}$ , $\frac{7}{64}$ , $\frac{1}{8}$ , $\frac{5}{32}$ , $\frac{3}{16}$		
		Star: T8, T10, T15, T20, T25, T27, T30, T40		
		$\frac{1}{4}$ Impact Driver Adaptor $\frac{1}{4}$ Auto Locking Magnetic Bit Holder		



## 32 PC. TAMPER PROOF BIT SET



### Slim and Compact Design Convenient Clip

- Industrial quality
- RC. Hardness 58-62
- Snap locking case
- Great for the job, home or garage

PART#	UPC#	SIZES/ITEMS	WT. PER PKG.	STD. PKG. UM
MTECH32TR	19818	Spanner: #6, #8, #10, #12, #14	.70	1
		Star Tamper: T8, T9, T10, T15, T20, T25, T27		
		Hex Tamper: $\frac{3}{32}$ , $\frac{1}{8}$ , $\frac{9}{64}$ , $\frac{5}{32}$ , $\frac{3}{16}$ , $\frac{7}{32}$ , $\frac{1}{4}$ , $\frac{5}{16}$		
		Tri-Wing: #1, #2, #3		
		Square: #1, #2, #3		
		Phillips: #2, #3		
		$\frac{1}{4}$ Impact Driver Adaptor $\frac{1}{4}$ Auto Locking Magnetic Bit Holder		

## STOP BITS

Don't guess how deep to drill! Let Metallics help!

### MSTD2061

Drill Diameter  $\frac{3}{8}$ "  
Useable Length  $1\frac{1}{16}$ "  
For  $\frac{1}{4}$ -20 Drop-In Anchor  
JDIA14



### MSTD2083

Drill Diameter  $\frac{1}{2}$ "  
Useable Length  $1\frac{11}{16}$ "  
For  $\frac{3}{8}$ -16 Drop-In Anchor  
JDIA38



### MSTD2086

Drill Diameter  $\frac{5}{8}$ "  
Useable Length  $2\frac{1}{16}$ "  
For  $\frac{1}{2}$ -13 Drop-In Anchor  
JDIA12



PART#	UPC#	DRILL DIAMETER	DROP-IN ANCHOR SIZE	WT. PER PKG.	STD. PKG. UM
MSTD2061	24568	$\frac{3}{8}$	$\frac{1}{4}$ -20	.20	1
MSTD2083	24569	$\frac{1}{2}$	$\frac{3}{8}$ -16	.20	1
MSTD2086	24570	$\frac{5}{8}$	$\frac{1}{2}$ -13	.21	1
<b>MINI</b>					
MSTD2061MINI	24571	$\frac{3}{8}$	$\frac{1}{4}$ -20	.18	1
MSTD2083MINI	24572	$\frac{1}{2}$	$\frac{3}{8}$ -16	.18	1

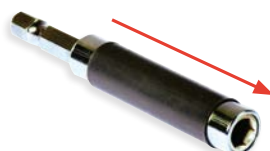

## SCREW SLEEVE GUIDE HOLDER

STOP DROPPING YOUR SCREWS!

Sleeve extends up to 8" (on 5" length sleeve guide) and 6" (on 3" length sleeve guide) to hold screw while fastening.

PART#	UPC#	SLEEVE	SHANK	WT. PER PKG.	STD. PKG. UM
SGH143	73954	3	$\frac{1}{4}$	.07	1
SGH145	73955	5	$\frac{1}{4}$	.10	1



**SCREW GUIDE BIT KIT**  
9 PIECE SET



PART#	UPC#	CONTENTS	WT. PER PKG.	STD. PKG. UM
SGBK	28012	1/ea Screw Guide 1/ea Phillips #1, #2, #3 1/ea Square #1, #2 1/ea Slotted #6F-#8R, #8R-#10F, #10R-#12R	.23	1



**AVIATION TIN SNIPS**  
HEAVY DUTY ALLOY STEEL

- Left cut – red handle
- Right cut – green handle
- Vinyl grips
- Straight cut – yellow handle
- 10 inch length
- Safety latch
- Serrated jaws
- Alloy steel construction

PART#	UPC#	DESCRIPTION	WT. PER PKG.	STD. PKG. UM
MAVSG	37468	Aviation Snip – Right Cut (Green)	.90	1
MAVSR	37469	Aviation Snip – Left Cut (Red)	.90	1
MAVSY	37470	Aviation Snip – Straight Cut (Yellow)	.90	1



**THREE-IN-ONE TAP THREAD CLEANING TOOL**

PART#	UPC#	DESCRIPTION	WT. PER PKG.	STD. PKG. UM
681032	16345	6-32,8-32,10-32 Thread Cleaning Tool	.21	1

OTHER SIZES AND QUANTITIES AVAILABLE BY REQUEST

**29 PIECE DRILL KITS**

Sizes Range From 1/16" – 1/2" x 64<sup>th</sup>

**The Case is...**

- Waterproof.
- Durable.
- Rust Resistant.

**The Drills are...**

- Premium grade high speed steel.
- Heavy duty 135° degree split point for self-centering and reducing thrust.
- Gold and black surface treated for use in stainless steel and other hard metal drilling.



1/16" – 1/2"



Handy belt clip

Secure screw on cap

PART#	UPC#	DESCRIPTION	WT. PER PKG.	STD. PKG. UM
BCK29	41834	135° Heavy Duty Split Point HSS Jobber Length Drill Kit	3.05	1
BCKE29	41835	135° Economy HSS Black and Gold Jobber Length Drill Kit	2.71	1

## HIGH-SPEED TWIST DRILLS FRACTIONAL SIZES



Individually  
Packaged



- Jobber length - 118° Point
- Fractional sizes
- Bright finish
- In single pouch

PART#	UPC#	SIZE	LENGTH	WT. PER PKG.	STD. PKG. UM
HSD1E	39801	1/16	1 7/8	.03	1
HSD2E	39802	5/64	2	.04	1
HSD3E	39803	3/32	2 1/4	.01	1
HSD4E	39804	7/64	2 5/8	.01	1
HSD5E	39805	1/8	2 3/4	.01	1
HSD6E	39806	9/64	2 7/8	.01	1
*HSD6BGO	24490	9/64	2 7/8	.08	1
HSD7E	39807	5/32	3 1/8	.01	1
HSD8E	39808	11/32	3 1/4	.02	1
HSD9E	39809	3/16	3 1/2	.03	1
HSD29E	39829	13/64	3 5/8	.03	1
HSD10E	39810	7/32	3 3/4	.03	1
HSD11E	39811	15/64	3 7/8	.04	1
HSD12E	39812	1/4	4	.04	1
HSD1212E	79763	1/4	12	.15	1
HSD13E	39813	17/64	4 1/8	.06	1
HSD14E	39814	9/32	4 1/4	.06	1
HSD15E	39815	19/64	4 3/8	.06	1
HSD16E	39816	5/16	4 1/2	.07	1
*HSD16RE	39916	5/16	4	.06	1
HSD17E	39817	21/64	4 5/8	.08	1
HSD18E	39818	11/32	4 3/4	.09	1
HSD19E	39819	23/64	4 7/8	.10	1
HSD20E	39820	3/8	5	.11	1
*HSD20RE	39920	3/8	4	.09	1
HSD21E	39821	25/64	5 1/8	.12	1
HSD22E	39822	13/32	5 1/4	.13	1
HSD23E	39823	27/64	5 3/8	.14	1
HSD24E	39824	7/16	5 1/2	.16	1
*HSD24RE	39924	7/16	4	.16	1
HSD25E	39850	29/64	5 5/8	.17	1
HSD26E	39826	15/32	5 3/4	.18	1
HSD27E	39827	31/64	5 7/8	.20	1
HSD28E	39828	1/2	6	.24	1
*HSD28RE	39928	1/2	4	.14	1
HSD29R38E	24463	1/2	4 1/2	.18	1
HSD916E	24466	9/16	8 1/4	.31	1
HSD58E	24467	5/8	8 3/4	.31	1
HSD50RE	24482	21/32	6	.23	1
HSD116E	24383	11/16	9 1/4	.38	1
HSD34E	24476	3/4	9 3/4	.41	1
HSD4964E	24308	49/64	6	.43	1
<b>TITANIUM</b>					
HSD10T	27210	7/32	3 3/4	.04	1
HSD29T	27229	13/64	3 3/4	.03	1

\*1/2 reduced shank - OTHER SIZES, MATERIALS AND QUANTITIES AVAILABLE BY REQUEST.



Individually  
Packaged

- Jobber length - 118° Point
- Black oxide finish
- In single pouch

HIGH-SPEED TWIST DRILLS  
NUMBERED SIZES

PART	UPC	SIZE	LENGTH	WT. PER PKG.	STD. PKG. UM
NHSD1E†	24798	1	3 <sup>7</sup> / <sub>8</sub>	.04	1
NHSD6E	39706	6	3 <sup>3</sup> / <sub>4</sub>	.04	1
NHSD7E	39707	7	3 <sup>5</sup> / <sub>8</sub>	.02	1
NHSDBG7E†	35436	7	3 <sup>5</sup> / <sub>8</sub>	.02	1
NHSDC7	35434	7	3 <sup>5</sup> / <sub>8</sub>	.02	1
NHSD8E	39708	8	3 <sup>5</sup> / <sub>8</sub>	.02	1
NHSD9E	39709	9	3 <sup>5</sup> / <sub>8</sub>	.02	1
NHSD10E	39710	10	3 <sup>5</sup> / <sub>8</sub>	.04	1
NHSD11E	39711	11	3 <sup>1</sup> / <sub>2</sub>	.02	1
NHSD11E	39711	11	3 <sup>1</sup> / <sub>2</sub>	.02	1
NHSD20E	39720	20	3 <sup>3</sup> / <sub>4</sub>	.03	1
NHSD21E	39721	21	3 <sup>3</sup> / <sub>4</sub>	.01	1
NHSDBG21E†	35437	21	3 <sup>3</sup> / <sub>4</sub>	.01	1
NHSDC21†	35433	21	3 <sup>3</sup> / <sub>4</sub>	.01	1
NHSD22E	39722	22	3 <sup>1</sup> / <sub>8</sub>	.01	1
NHSD25E	39725	25	3	.01	1
*NHSD25SE	24848	25	2 <sup>1</sup> / <sub>16</sub>	.01	1
NHSD26E	39726	26	3	.01	1
NHSD28E	39728	28	2 <sup>7</sup> / <sub>8</sub>	.01	1
NHSD29E	39729	29	2 <sup>7</sup> / <sub>8</sub>	.01	1
NHSD29SE*	24849	29	1 <sup>15</sup> / <sub>16</sub>	.02	1
NHSD30E	39730	30	2 <sup>3</sup> / <sub>4</sub>	.01	1
NHSD31E	39731	31	2 <sup>3</sup> / <sub>4</sub>	.01	1
NHSD35E	39735	35	2 <sup>5</sup> / <sub>8</sub>	.01	1
NHSD36E	35432	36	2 <sup>1</sup> / <sub>2</sub>	.01	1
NHSDC36†	39736	36	2 <sup>1</sup> / <sub>2</sub>	.03	1
NHSD37E	39737	37	2 <sup>1</sup> / <sub>2</sub>	.01	1
NHSD43E	39743	43	2 <sup>1</sup> / <sub>4</sub>	.01	1
NHSD45E	39745	45	2 <sup>1</sup> / <sub>8</sub>	.01	1
NHSD77E	24813	77	7 <sup>7</sup> / <sub>8</sub>	.01	1

\*ZINC FINISH, †135° SPLIT POINT – OTHER SIZES, MATERIALS AND QUANTITIES AVAILABLE BY REQUEST.



HIGH-SPEED TWIST DRILLS  
JOBBER LENGTH - WIRE GAUGE SIZES - LETTER SIZES

PART	UPC	SIZE	OVERALL LENGTH	WT. PER PKG.	STD. PKG. UM
<b>WIRE GAUGE SIZES 118° POINTS</b>					
NHSD2	24802	2	3 <sup>7</sup> / <sub>8</sub>	.29	10
NHSD3	24803	3	3 <sup>3</sup> / <sub>4</sub>	.25	10
NHSD4	24804	4	3 <sup>3</sup> / <sub>4</sub>	.23	10
NHSD5	24805	5	3 <sup>3</sup> / <sub>4</sub>	.23	10
NHSD6	24806	6	3 <sup>3</sup> / <sub>4</sub>	.40	10
NHSD7	24807	7	3 <sup>5</sup> / <sub>8</sub>	.20	10
NHSD8	24808	8	3 <sup>5</sup> / <sub>8</sub>	.21	10
NHSD9	24809	9	3 <sup>5</sup> / <sub>8</sub>	.37	10
NHSD10	24810	10	3 <sup>5</sup> / <sub>8</sub>	.22	10
NHSD11	24811	11	3 <sup>1</sup> / <sub>2</sub>	.22	10
NHSD14	24814	14	3 <sup>3</sup> / <sub>8</sub>	.18	10
NHSD16	24816	16	3 <sup>3</sup> / <sub>8</sub>	.15	10
NHSD17	24817	17	3 <sup>3</sup> / <sub>8</sub>	.13	10
NHSD18	24818	18	3 <sup>1</sup> / <sub>4</sub>	.12	10
NHSD19	24819	19	3 <sup>1</sup> / <sub>4</sub>	.12	10
NHSD20	24820	20	3 <sup>1</sup> / <sub>4</sub>	.25	10
NHSD21	24821	21	3 <sup>1</sup> / <sub>4</sub>	.14	10
NHSD22	24822	22	3 <sup>1</sup> / <sub>8</sub>	.13	10

OTHER SIZES AND QUANTITIES AVAILABLE BY REQUEST

CONTINUED ON NEXT PAGE  
[www.metallics.us](http://www.metallics.us)



# TOOLS, DRILLS AND ACCESSORIES

CONTINUED

## HIGH-SPEED TWIST DRILLS JOBBER LENGTH - WIRE GAUGE SIZES - LETTER SIZES



PART	UPC	SIZE	OVERALL LENGTH	WT. PER PKG.	STD. PKG. UM
<b>WIRE GAUGE SIZES 118° POINTS</b>					
NHSD23	24823	23	3 <sup>1</sup> / <sub>8</sub>	.12	10
NHSD24	24824	24	3 <sup>1</sup> / <sub>8</sub>	.12	10
NHSD25	24825	25	3	.12	10
NHSD26	24826	26	3	.11	10
NHSD27	24827	27	3	.08	10
NHSD28	24828	28	2 <sup>7</sup> / <sub>8</sub>	.10	10
NHSD29	24829	29	2 <sup>7</sup> / <sub>8</sub>	.10	10
NHSD30	24830	30	2 <sup>3</sup> / <sub>4</sub>	.08	10
NHSD31	24831	31	2 <sup>3</sup> / <sub>4</sub>	.08	10
NHSD32	35435	32	2 <sup>3</sup> / <sub>4</sub>	.08	10
NHSD33	24833	33	2 <sup>5</sup> / <sub>8</sub>	.07	10
NHSD35	24835	35	2 <sup>5</sup> / <sub>8</sub>	.07	10
NHSD36	24836	36	2 <sup>1</sup> / <sub>2</sub>	.06	10
NHSD37	24837	37	2 <sup>1</sup> / <sub>2</sub>	.06	10
NHSD39	24839	39	2 <sup>3</sup> / <sub>8</sub>	.05	10
NHSD41	24841	41	2 <sup>3</sup> / <sub>8</sub>	.05	10
<b>WIRE GAUGE SIZES 118° POINTS</b>					
NHSD43	24843	43	2 <sup>1</sup> / <sub>4</sub>	.05	10
NHSD44	24844	44	2 <sup>1</sup> / <sub>8</sub>	.04	10
NHSD50	25150	50	2	.03	10
<b>LETTER SIZES</b>					
HSDFE	28406	F	4 <sup>1</sup> / <sub>8</sub>	.05	1
NHSDNE	35458	N	4 <sup>3</sup> / <sub>8</sub>	.07	1
HSDQE	28417	Q	4 <sup>3</sup> / <sub>4</sub>	.08	1
NHSDUE	35459	U	5	.09	1
NHSDZE	35460	Z	5 <sup>1</sup> / <sub>4</sub>	.10	1

OTHER SIZES AND QUANTITIES AVAILABLE BY REQUEST

## HIGH-SPEED TWIST DRILLS JOBBER LENGTH FRACTIONAL SIZES



PART#	UPC#	SIZE	OVERALL LENGTH	WT. PER PKG.	STD. PKG. UM
<b>FRACTIONAL SIZES 118° POINTS</b>					
HSD31	24472	3 <sup>3</sup> / <sub>64</sub>	1 <sup>3</sup> / <sub>4</sub>	.02	5
HSD1	24300	1 <sup>1</sup> / <sub>16</sub>	1 <sup>7</sup> / <sub>8</sub>	.03	10
HSD2	24305	5 <sup>5</sup> / <sub>64</sub>	2	.04	10
HSD3	24310	3 <sup>3</sup> / <sub>32</sub>	2 <sup>1</sup> / <sub>4</sub>	.05	10
HSD4	24315	7 <sup>7</sup> / <sub>64</sub>	2 <sup>5</sup> / <sub>8</sub>	.07	10
HSD5	24320	1 <sup>1</sup> / <sub>8</sub>	2 <sup>3</sup> / <sub>4</sub>	.09	10
HSD6	24325	9 <sup>9</sup> / <sub>64</sub>	2 <sup>7</sup> / <sub>8</sub>	.11	10
HSD7	24330	5 <sup>5</sup> / <sub>32</sub>	3 <sup>1</sup> / <sub>8</sub>	.14	10
HSD8	24335	11 <sup>11</sup> / <sub>64</sub>	3 <sup>1</sup> / <sub>4</sub>	.17	10
HSD9	24340	3 <sup>3</sup> / <sub>16</sub>	3 <sup>1</sup> / <sub>2</sub>	.21	10
HSD29	24345	13 <sup>13</sup> / <sub>64</sub>	3 <sup>5</sup> / <sub>8</sub>	.26	10
HSD10	24350	7 <sup>7</sup> / <sub>32</sub>	3 <sup>3</sup> / <sub>4</sub>	.26	10
HSD11	24355	15 <sup>15</sup> / <sub>64</sub>	3 <sup>7</sup> / <sub>8</sub>	.35	10
HSD12	24360	1 <sup>1</sup> / <sub>4</sub>	4	.41	10
HSD13	24365	17 <sup>17</sup> / <sub>64</sub>	4 <sup>1</sup> / <sub>8</sub>	.29	5
HSD14	24370	9 <sup>9</sup> / <sub>32</sub>	4 <sup>1</sup> / <sub>4</sub>	.28	5
HSD15	24375	19 <sup>19</sup> / <sub>64</sub>	4 <sup>3</sup> / <sub>8</sub>	.32	5
HSD16	24380	5 <sup>5</sup> / <sub>16</sub>	4	.36	5
*HSD16R	24385	5 <sup>5</sup> / <sub>16</sub>	3 <sup>13</sup> / <sub>16</sub>	.32	5
HSD17	24390	2 <sup>1</sup> / <sub>64</sub>	4 <sup>5</sup> / <sub>8</sub>	.39	5
HSD18	24395	1 <sup>1</sup> / <sub>32</sub>	4 <sup>3</sup> / <sub>4</sub>	.44	5

INCLUDED  
IN HSCD1 DRILL  
DISPLAY

NOT INCLUDED

\*1/4 reduced shank - OTHER SIZES AND QUANTITIES AVAILABLE BY REQUEST

CONTINUED ON NEXT PAGE  
[www.metallics.us](http://www.metallics.us)

CONTINUED  
HIGH-SPEED TWIST DRILLS  
JOBBER LENGTH FRACTIONAL SIZES



PART#	UPC#	SIZE	OVERALL LENGTH	WT. PER PKG.	STD. PKG. UM
<b>FRACTIONAL SIZES 118° POINTS</b>					
HSD19	24400	23/64	47/8	.48	5
HSD20	24405	3/8	5	.55	5
*HSD20R	24410	3/8	4	.43	5
HSD21	24415	25/64	51/8	.60	5
HSD22	24420	13/32	51/4	.64	5
HSD23	24425	27/64	53/8	.72	5
HSD24	24430	7/16	51/2	.82	5
*HSD24R	24435	7/16	411/16	.78	5
HSD25	24440	29/64	55/8	.86	5
HSD26	24445	15/32	53/4	.89	5
HSD27	24450	31/64	57/8	1.00	5
HSD28	24455	1/2	6	1.16	5
*HSD28R	24460	1/2	4	.07	5

\*1/4 reduced shank – OTHER SIZES AND QUANTITIES AVAILABLE BY REQUEST

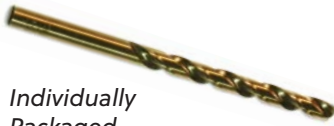

Individually  
Packaged

HEAVY DUTY COBALT STEEL  
135° SPLIT POINT DRILLS  
FRACTIONAL SIZES

Cobalt Steel, Jobber Length  
- 135° Point, Yellow Finish, In  
Single Pouch

**USES**

- Hardened Steel
- Stainless Steel
- High Temp Alloys
- Heat Treated Material
- Abrasive Plastics
- Titanium

PART#	UPC#	SIZE	LENGTH	WT. PER PKG.	STD. PKG. UM
HSSC1E	28201	1/16	17/8	.01	1
HSSC2E	28202	5/64	2	.01	1
HSSC3E	28203	3/32	21/4	.01	1
HSSC4E	28204	7/64	25/8	.01	1
HSSC5E	28205	1/8	23/4	.02	1
HSSC6E	28206	9/64	27/8	.02	1
HSSC7E	28207	5/32	31/8	.02	1
HSSC8E	28208	11/64	31/4	.03	1
HSSC9E	28209	3/16	31/2	.03	1
HSSC29E	28229	13/64	35/8	.03	1
HSSC10E	28210	7/32	33/4	.04	1
HSSC11E	28211	15/64	37/8	.05	1
HSSC12E	28212	1/4	4	.05	1
HSSC13E	28213	17/64	41/8	.05	1
HSSC14E	28214	9/32	41/4	.06	1
HSSC15E	28215	19/64	43/8	.06	1
HSSC16E	28216	5/16	41/2	.08	1
HSSC17E	28217	21/64	45/8	.08	1
HSSC18E	28218	11/32	43/4	.08	1
HSSC19E	28219	23/64	47/8	.10	1
HSSC20E	28220	3/8	5	.13	1
HSSC21E	28221	25/64	51/8	.12	1
HSSC22E	28222	13/32	51/4	.13	1
HSSC23E	28223	27/64	53/8	.15	1
HSSC24E	28224	7/16	51/2	.19	1
HSSC25E	28225	29/64	55/8	.19	1
HSSC26E	28226	15/32	53/4	.19	1
HSSC27E	28227	31/64	57/8	.20	1
HSSC28E	28228	1/2	6	.26	1
HSSC30E	28231	9/16	61/8	.30	1
HSSC40E	28241	5/8	61/4	.34	1
HSSC41E	28242	11/16	65/8	.38	1
HSSC42E	28243	3/4	63/4	.43	1
HSSC43E	28244	7/8	7	.48	1
HSSC44E	24245	1	71/8	.54	1

OTHER SIZES, MATERIALS AND QUANTITIES AVAILABLE BY REQUEST.



Individually  
Packaged

Cobalt Steel, Jobber Length -  
135° Point, Wire Gauge Sizes,  
Yellow Finish, In Single Pouch

**USES**

- Hardened Steel
- Stainless Steel
- High Temp Alloys
- Heat Treated Material
- Abrasive Plastics
- Titanium

## HEAVY DUTY COBALT STEEL 135° SPLIT POINT DRILLS FRACTIONAL SIZES

PART#	UPC#	SIZE	LENGTH	WT. PER PKG.	STD. PKG. UM
<b>GOLD</b>					
HSSC1	95201	1/16	1 7/8	.01	1
HSSC2	95202	5/64	2	.01	1
HSSC3	95203	3/32	2 1/4	.01	1
HSSC4	95204	7/64	2 5/8	.01	1
HSSC5	95205	1/8	2 3/4	.02	1
HSSC6	95206	9/64	2 7/8	.02	1
HSSC7	95207	5/32	3 1/8	.02	1
HSSC8	95208	11/64	3 1/2	.03	1
HSSC9	95209	3/16	3 1/2	.03	1
HSSC10	95210	13/64	3 5/8	.03	1
HSSC11	95211	7/32	3 3/4	.04	1
HSSC12	95212	15/64	3 7/8	.05	1
HSSC13	95213	1/4	4	.05	1
HSSC14	95214	17/64	4 1/8	.06	1
HSSC15	95215	9/32	4 1/4	.06	1
HSSC16	95216	19/64	4 3/8	.07	1
HSSC17	95217	5/16	4 1/2	.08	1
HSSC18	95218	21/64	4 5/8	.09	1
HSSC19	95219	11/32	4 3/4	.10	1
HSSC20	95220	23/64	4 7/8	.11	1
HSSC21	95221	3/8	5	.12	1
HSSC22	95222	25/64	5 1/8	.13	1
HSSC23	95223	13/32	5 1/4	.13	1
HSSC24	95224	27/64	5 3/8	.15	1
HSSC25	95225	7/16	5 1/2	.16	1

OTHER SIZES, MATERIALS AND QUANTITIES AVAILABLE BY REQUEST.



Individually  
Packaged

- Cobalt Steel
- Jobber Length - 135° Point
- Wire Gauge Sizes
- Yellow Finish
- In Single Pouch

**USES**

- Hardened Steel
- Stainless Steel
- High Temp Alloys
- Heat Treated Material
- Abrasive Plastics
- Titanium

## HEAVY DUTY COBALT STEEL 135° SPLIT POINT DRILLS FRACTIONAL SIZES

PART#	UPC#	SIZE	LENGTH	WT. PER PKG.	STD. PKG. UM
<b>GOLD</b>					
HSSC26	95226	29/64	5 5/8	.19	1
HSSC27	95227	15/32	5 3/4	.19	1
HSSC28	95228	31/64	5 7/8	.22	1
HSSC29	95229	1/2	6	.26	1
HSSC30	95230	13/16	6 1/8	.42	1
<b>BLACK</b>					
HSSCBLK5	99505	1/8	2 3/4	.02	1
HSSCBLK13	99513	1/4	4	.05	1
HSSCBLK29	99529	1/2	6	.26	1

OTHER SIZES, MATERIALS AND QUANTITIES AVAILABLE BY REQUEST.



**HEAVY DUTY COBALT STEEL  
135° SPLIT POINT DRILLS  
WIRE GAUGE SIZES**

Individually  
Packaged

- Cobalt Steel
- Jobber Length - 135° Point
- Wire Gauge Sizes
- Yellow Finish
- In Single Pouch

**USES**

- Hardened Steel
- Stainless Steel
- High Temp Alloys
- Heat Treated Material
- Abrasive Plastics
- Titanium

PART	UPC#	SIZE	LENGTH	WT. PER PKG.	STD. PKG. UM
HSSCN6E	28306	#6	3¾	.04	1
HSSCN7E	28307	#7	3 <sup>5</sup> / <sub>8</sub>	.02	1
HSSCN8E	28308	#8	3 <sup>5</sup> / <sub>8</sub>	.02	1
HSSCN9E	28309	#9	3 <sup>5</sup> / <sub>8</sub>	.02	1
HSSCN10E	28310	#10	3 <sup>5</sup> / <sub>8</sub>	.02	1
HSSCN11E	28311	#11	3½	.01	1
HSSCN12E	28312	#12	3½	.01	1
HSSCN17E	28317	#17	3 <sup>3</sup> / <sub>8</sub>	.01	1
HSSCN20E	28320	#20	3¼	.01	1
HSSCN21E	28321	#21	3¼	.01	1
HSSCN22E	28322	#22	3 <sup>1</sup> / <sub>8</sub>	.01	1
HSSCN25E	28325	#25	3	.01	1
HSSCN26E	28326	#26	3	.01	1
HSSCN27E	27389	#27	3	.21	1
HSSCN28E	28328	#28	2 <sup>7</sup> / <sub>8</sub>	.01	1
HSSCN29E	28329	#29	2 <sup>7</sup> / <sub>8</sub>	.01	1
HSSCN30E	28330	#30	2¾	.01	1
HSSCN31E	28331	#31	2¾	.01	1
HSSCN32E	27392	#32	2¾	.01	1
HSSCN35E	28335	#35	2 <sup>5</sup> / <sub>8</sub>	.01	1
HSSCN36E	28336	#36	2½	.01	1
HSSCN37E	28337	#37	2½	.01	1
HSSCN40E	28340	#40	2¾	.01	1
HSSCN43E	28343	#43	2¼	.01	1

OTHER SIZES AND QUANTITIES AVAILABLE BY REQUEST



**1135° SPLIT POINT HEAVY DUTY  
AIRCRAFT HIGH SPEED DRILL  
FOR STAINLESS STEEL**

PART#	UPC#	SIZE	OVERALL LENGTH	WT. PER PKG.	STD. PKG. UM
HSDAC20	27420	No. 20	6	.06	1
HSDAC27	27427	No. 27	6	.04	1
HSDAC32	27432	No. 32	6	.03	1

OTHER SIZES AND QUANTITIES AVAILABLE BY REQUEST

**MAGNETIC BIT HOLDER AND NUT SETTER KITS**

- Each kit contains one of each of:
  - ¼ x 1<sup>5</sup>/<sub>8</sub> magnetic nut setter,
  - ¼ x 2<sup>9</sup>/<sub>16</sub> magnetic nut setter,
  - ¼ x 4 magnetic nut setter,
  - ¼ x 6 magnetic nut setter,
  - 5/16 x 1<sup>5</sup>/<sub>8</sub> magnetic nut setter,
  - 5/16 x 2<sup>9</sup>/<sub>16</sub> magnetic nut setter,
  - 5/16 x 4 magnetic nut setter,
  - 5/16 x 6 magnetic nut setter, and
  - 3/8 x 1<sup>5</sup>/<sub>8</sub> magnetic nut setter
- The MTKQ10 also includes a ¼ quick change drill chuck adapter.
- All pieces come in a handy X-Large 6 compartment poly box.



(MTKQ9) 9 Piece Nut Setter Kit



(MTKQ10) 10 Piece Nut Setter Kit

PART#	UPC#	DESCRIPTION	WT. PER PKG.	STD. PKG. UM
MTKQ9	13246	9 Piece Magnetic Bit Holder and Nut Setter Kit	1.30	1
MTKQ10	13251	10 Piece Magnetic Bit Holder and Nut Setter Kit	1.39	1
DCA1	32764	¼ Quick Change Drill Chuck Adapter	.07	1



## MAGNETIC BIT AND NUT SETTER KIT











- Three sizes of Nut Setters and one size Bit Holders
- Magnetized for ease of use
- Be professional, be prepared

PART#	UPC#	DESCRIPTION	SIZE	QTY. EACH	WT. PER PKG.	STD. PKG. UM
MTKQ	10890	Mag. Hex Bit Holder	¼ x 2	2	.80	1
		Mag Nut Setter	¼ x 2	2		
		Mag Nut Setter	5/16 x 2	2		
		Mag Nut Setter	3/8 x 2	2		

OTHER SIZES AND QUANTITIES AVAILABLE BY REQUEST

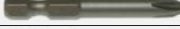

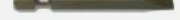

## POWER BITS AND MAGNETIC HOLDERS

PART#	UPC#	DESCRIPTION	LENGTH	WT. PER PKG.	STD. PKG. UM	
000P1X	25070	#1 Phillips Insert Bit		1	.18	10
000P2X	25074	#2 Phillips Insert Bit		1	.19	10
000P3X	25080	#3 Phillips Insert Bit		1	.19	10
000R2X	25055	#2 Square Drive Insert Bit		1	.19	10
0016X	25235	6-8 Slotted Insert Bit		1	.19	10
0018X	25240	8-10 Slotted Insert Bit		1	.19	10
00110X	25245	10-12 Slotted Insert Bit		1	.19	10
100P1X	25300	#1 Phillips Power Bit		2	.17	5
100P2X	25305	#2 Phillips Power Bit		2	.19	5
100P3X	25312	#3 Phillips Power Bit		2	.20	5
1008X	25415	8-10 Slotted Power Bit		2	.21	5
10010X	25314	10-12 Slotted Power Bit		2	.21	5

OTHER SIZES AND QUANTITIES AVAILABLE BY REQUEST

## ¼" HEX SHANK SCREWDRIVER POWER BITS AND HOLDERS







	PART#	UPC#	SCREW SIZE	POINT SIZE	OVERALL LENGTH	WT. PER PKG.	STD. PKG. UM
<b>PHILLIPS INSERT &amp; POWER BITS</b>    	000P0B	25067	0	#1	1	.01	1
	000P1B	25071	4-6	#1	1	.01	1
	000P2B	25076	8-10	#2	1	.01	1
	000P2BB	25077	8-10	#2	1	.61	50
	000P2R*	25026	8-10	#2	1	.01	1
	000P3B	25081	12-14	#3	1	.01	1
	001P2B	25085	8-10	#2	1¼	.02	1
	100P1B	25301	4-6	#1	2	.02	1
	100P2B	25306	8-10	#2	2	.02	1
	100P3B	25310	12-14	#3	2	.02	1
	125P1B	25315	4-6	#1	3	.02	1
	125P2B	25320	8-10	#2	3	.04	1
	125P3B	25325	12-14	#3	3	.03	1
	140P1B	25345	4-6	#1	4	.04	1
	140P2B	25350	8-10	#2	4	.05	1
	140P3B	25355	12-14	#3	4	.05	1
	160P1B	25333	4-6	#1	6	.05	1
	160P2B	25351	8-10	#2	6	.06	1
	160P3B	27340	12-14	#3	6	.09	1

\* Reduced body – OTHER SIZES AND QUANTITIES AVAILABLE BY REQUEST

CONTINUED ON NEXT PAGE

CONTINUED

¼" HEX SHANK SCREWDRIVER  
POWER BITS AND HOLDERS

	PART#	UPC#	SCREW SIZE	POINT SIZE	OVERALL LENGTH	WT. PER PKG.	STD. PKG. UM
<b>SLOTTED INSERT &amp; POWER BITS</b> 	<b>0001B</b>	25211	0-1	1	1	.01	1
	<b>00112B</b>	25246	2-3	2-3	1	.01	1
	<b>0013B</b>	10181	3-4	3-4	1	.01	1
	<b>0014B</b>	25225	4-5	4-5	1	.01	1
	<b>0016B</b>	25236	6-8	6-8	1	.01	1
	<b>0018B</b>	25241	8-10	8-10	1	.01	1
	<b>00110B</b>	25206	10-12	10-12	1	.01	1
	<b>0004B</b>	25190	4-5	4-5	1½	.02	1
	<b>0006B</b>	25195	6-8	6-8	1½	.02	1
	<b>0008B</b>	25200	8-10	8-10	1½	.03	1
	<b>00010B</b>	25205	10-12	10-12	1½	.03	1
	<b>1004B</b>	25400	4-5	4-5	2	.02	1
	<b>1005B</b>	12279	5-6	5-6	2	.02	1
	<b>1006B</b>	25410	6-8	6-8	2	.03	1
	<b>1008B</b>	25416	8-10	8-10	2	.03	1
	<b>10010B</b>	25420	10-12	10-12	2	.03	1
	<b>SLOTTED INSERT &amp; POWER BITS</b> 	<b>1254B</b>	25322	4-5	4-5	3	.04
<b>1256B</b>		25440	6-8	6-8	3	.04	1
<b>1258B</b>		25445	8-10	8-10	3	.04	1
<b>12510B</b>		25450	10-12	10-12	3	.05	1
<b>12512B</b>		25455	12-14	12-14	3	.06	1
<b>1408B</b>		27330	8-10	8-10	4	.05	1
<b>1608B</b>		27335	8-10	8-10	6	.12	1
<b>SQUARE DRIVE INSERT BITS</b> 	<b>000R1B</b>	25050	4-6	#1	1	.01	1
	<b>000R2B</b>	25056	8-10	#2	1	.01	1
	<b>000R3B</b>	25060	12-14	#3	1	.01	1
	<b>100R1B</b>	25065	4-6	#1	2	.01	1
	<b>100R2B</b>	25072	8-10	#2	2	.02	1
	<b>100R3B</b>	25075	12-14	#3	2	.02	1
	<b>125R1B</b>	10149	4-6	#1	3	.03	1
	<b>125R2B</b>	10166	8-10	#2	3	.04	1
	<b>125R3B</b>	10167	12-14	#3	3	.04	1
	<b>140R1B</b>	10176	4-6	#1	4	.04	1
	<b>140R2B</b>	10177	8-10	#2	4	.05	1
	<b>140R3B</b>	10180	12-14	#3	4	.05	1
	<b>SQUARE DRIVE INSERT BITS</b> 	<b>160R1B</b>	27345	6-8	#1	6	.03
<b>160R2B</b>		25352	8-10	#2	6	.07	1
<b>160R3B</b>		25357	12-14	#3	6	.07	1
<b>180R2B</b>		10193	8-10	#2	8	.11	1
<b>110R2B</b>		10175	8-10	#2	12	.12	1
<b>DOUBLE ENDED INSERT BITS</b> 		<b>P2S8</b>	25505	#2 Phil/#2Slot		1½	.18
	<b>P2P2</b>	25510	#2 Phil/#2 Phil		1¾	.11	1
	<b>P1P1B</b>	17862	#1 Phil/#1 Phil		2	.02	1
	<b>P2P2B</b>	10178	#2 Phil/#2 Phil		2	.02	1
	<b>P2S8B</b>	10179	#2 Phil/8-10 Slot		1¾	.02	1
	<b>41SQ</b>	28975	#1 Square/#2 Square		2	.04	1
<b>SPANNER INSERT BITS</b> 	<b>00SP4B</b>	25034	Spanner	#4	1	.01	1
	<b>00SP6B</b>	25027	Spanner	#6	1	.01	1
	<b>00SP8B</b>	10195	Spanner	#8	1	.01	1
	<b>00SP10B</b>	10196	Spanner	#10	1	.04	1
	<b>00SP12B</b>	10194	Spanner	#12	1	.01	1
	<b>00SP14B</b>	10197	Spanner	#14	1	.01	1

\* Reduced body – OTHER SIZES AND QUANTITIES AVAILABLE BY REQUEST



# TOOLS, DRILLS AND ACCESSORIES

CONTINUED

## ¼" HEX SHANK SCREWDRIVER POWER BITS AND HOLDERS

	PART#	UPC#	SCREW SIZE	OVERALL LENGTH	WT. PER PKG.	STD. PKG. UM
<b>MAGNETIC BIT HOLDER &amp; NUT SETTERS</b> 	<b>M1B</b>	25260	¼ Mag Bit Hldr	1¾	.04	1
	<b>M10B</b>	25255	¼ Mag Bit Hldr	2 <sup>7</sup> / <sub>8</sub>	.08	1
	<b>M10BB</b>	25256	¼ Mag Bit Hldr	2 <sup>7</sup> / <sub>8</sub>	4.57	50
	<b>M14B</b>	27350	¼ Mag Bit Hldr	4	.10	1
	<b>M16B</b>	27355	¼ Mag Bit Hldr	6	.15	1
	<b>MT208</b>	10870	¼ Drill Chuck Nut Setter	1¾	.15	1
	<b>MT209B</b>	10874	¼ Drill Chuck Nut Setter	2 <sup>1</sup> / <sub>8</sub>	.05	1
	<b>MT208L</b>	10875	¼ Drill Chuck Long Nut Setter	2 <sup>9</sup> / <sub>16</sub>	.20	1
	<b>MT210</b>	10871	<sup>5</sup> / <sub>16</sub> Drill Chuck Nut Setter	1¾	.12	1
	<b>MT210L</b>	10876	<sup>5</sup> / <sub>16</sub> Drill Chuck Long Nut Setter	2 <sup>9</sup> / <sub>16</sub>	.22	1
	<b>MT212</b>	10872	<sup>3</sup> / <sub>8</sub> Drill Chuck Nut Setter	1¾	.18	1
	<b>MT212L</b>	10877	<sup>3</sup> / <sub>8</sub> Drill Chuck Long Nut Setter	2 <sup>9</sup> / <sub>16</sub>	.25	1
	<b>MT214L</b>	10529	<sup>7</sup> / <sub>16</sub> Drill Chuck Long Nut Setter	2 <sup>9</sup> / <sub>16</sub>	.05	1
	<b>M10</b>	25250	¼ Hex Insert Bit Holder	2 <sup>7</sup> / <sub>8</sub>	.16	1
	<b>MT208B</b>	10183	¼ Mag Nut Setter	1 <sup>5</sup> / <sub>8</sub>	.04	1
	<b>MT208LB</b>	10186	¼ Mag Nut Setter	2 <sup>9</sup> / <sub>16</sub>	.06	1
	<b>MT210B</b>	10184	<sup>5</sup> / <sub>16</sub> Mag Nut Setter	1 <sup>5</sup> / <sub>8</sub>	.06	1
	<b>MT210LB</b>	10187	<sup>5</sup> / <sub>16</sub> Mag Nut Setter	2 <sup>9</sup> / <sub>16</sub>	.07	1
	<b>MT212B</b>	10185	<sup>3</sup> / <sub>8</sub> Mag Nut Setter	1 <sup>5</sup> / <sub>8</sub>	.05	1
	<b>MT212LB</b>	10188	<sup>3</sup> / <sub>8</sub> Mag Nut Setter	2 <sup>9</sup> / <sub>16</sub>	.08	1

OTHER SIZES AND QUANTITIES AVAILABLE BY REQUEST



## EXTRA LONG POWER BITS

PART#	UPC#	SIZE	LENGTH	WT. PER PKG.	STD. PKG. UM	SUGGESTED TRADE LIST PRICE PER
<b>MT208L4</b>	27150	¼	4	.22	2	25.12/ea
<b>MT208L6</b>	27155	¼	6	.36	2	29.80/ea
<b>MT210L4</b>	10523	<sup>5</sup> / <sub>16</sub>	4	.20	2	28.64/ea
<b>MT210L6</b>	10526	<sup>5</sup> / <sub>16</sub>	6	.22	2	44.09/ea
<b>MT212L4</b>	27165	<sup>3</sup> / <sub>8</sub>	4	.25	2	31.88 /ea
<b>MT212L6</b>	27170	<sup>3</sup> / <sub>8</sub>	6	.39	2	56.99/ea
<b>MT208L4B</b>	27151	¼	4	.11	1	14.49/ea
<b>MT208L6B</b>	27156	¼	6	.16	1	17.71/ea
<b>MT210L4B</b>	10524	<sup>5</sup> / <sub>16</sub>	4	.11	1	14.31/ea
<b>MT210L6B</b>	10527	<sup>5</sup> / <sub>16</sub>	6	.07	1	22.03/ea
<b>MT212L4B</b>	27166	<sup>3</sup> / <sub>8</sub>	4	.13	1	19.00/ea
<b>MT212L6B</b>	27171	<sup>3</sup> / <sub>8</sub>	6	.18	1	35.74/ea

OTHER SIZES, MATERIALS AND QUANTITIES AVAILABLE BY REQUEST.

## MASONRY DRILLS FOR CONCRETE SCREWS

Can be used with the  
Metallics QuaDrive  
Concrete Screws



PART#	UPC#	SIZE	SCREW DIA.	WT. PER PKG.	STD. PKG. UM	SUGGESTED TRADE LIST PRICE PER
<b>CD1</b>	31250	<sup>5</sup> / <sub>32</sub> X 3½	<sup>3</sup> / <sub>16</sub>	.02	1	5.36/ea
<b>CD2</b>	31255	<sup>5</sup> / <sub>32</sub> X 4½	<sup>3</sup> / <sub>16</sub>	.02	1	6.32/ea
<b>CD3</b>	31260	<sup>5</sup> / <sub>32</sub> X 5½	<sup>3</sup> / <sub>16</sub>	.02	1	7.19/ea
<b>CD5</b>	31265	<sup>3</sup> / <sub>16</sub> X 3½	¼	.02	1	5.47/ea
<b>CD6</b>	31270	<sup>3</sup> / <sub>16</sub> X 4½	¼	.02	1	6.47/ea
<b>CD7</b>	31275	<sup>3</sup> / <sub>16</sub> X 5½	¼	.03	1	9.18/ea
<b>CD8</b>	31280	<sup>3</sup> / <sub>16</sub> X 6¾	¼	.05	1	11.79/ea

OTHER SIZES AND QUANTITIES AVAILABLE BY REQUEST



**CONCRETE SCREW INSTALLATION KIT**  
8 PIECE KIT

- 1 - Drill Driver
  - 2 - Hex Drivers
  - 2 - Phillips Bits
  - 1 - Drill Adapter
  - 1 - Phillips Bit Holder
  - 1 - Allen Hex Key
- Drill Bit Not Included*

PART#	UPC#	DESCRIPTION	WT. PER PKG.	STD. PKG. UM
<b>KIT</b>				
IT1000	31200	Installation Tool (complete kit)	.95	1
<b>REPLACEMENT COMPONENTS FOR KIT</b>				
MHD14	31205	¼ Magnetic Hex Driver	.04	1
MHD56	31210	5/16 Magnetic Hex Driver	.05	1
PBH	31215	#2 & #3 Phillips Bit Holder	.01	1
ITSLEVE	31203	Drill/Driver Adapter	.28	1
PB2	31220	#2 Phillips Bit	.01	1
PB3	31225	#3 Phillips Bit	.01	1
HK1	31230	1/8 Allen Hex Key	.01	1

OTHER SIZES AND QUANTITIES AVAILABLE BY REQUEST

**SELECT-A-DRILL**



**SAD13 - 13 Piece Select-A-Drill Kit**  
Thirteen (13) high-speed jobber length drills from 1/16" to 1/4" by 64ths. Popular sizes in a unique rotating case

118° POINT

**SAD21 - 21 Piece Select-A-Drill Kit**  
Twenty-one (21) high-speed jobber length drills from 1/16" to 3/8" by 64ths. Popular sizes in a unique rotating case



PART#	UPC#	WT. PER PKG.	STD. PKG. UM
SAD13	24520	.32	1
SAD21	24525	.90	1

**HIGH-SPEED DRILL KITS**



PART#	UPC#	QTY. DRILLS	DRILL SIZES	WT. PER PKG.	STD. PKG. UM
HSDK1	24510	29	1/16 - 1/2 by 1/64ths 135°	3.35	1
HSDK2	24505	15	1/16 - 1/2 by 1/32nds 135°	2.05	1
HSDK3	24500	13	1/16 - 1/4 by 1/64ths 135°	.65	1
HSDK4	24534	20	#60-#80	1.91	1
HSDK5	24535	29	1/16 - 1/2 by 1/64ths 135°	3.35	1
HSDK6	24536	8	9/16 - 1 118°	5.84	1
HSDK8	24518	8	9/16 - 1 118°	5.04	1
HSDK21	24512	21	1/16 - 3/8 by 1/64ths 135°	1.34	1

**HEX SHANK DRILL SET**  
5 PIECE SET

118° POINT

5 Drills: 3/32, 7/64, 1/8, 9/64, 5/32



PART#	UPC#	WT. PER PKG.	STD. PKG. UM
DHS5	24530	.15	Set of 5 drills

## TAP AND DRILL BIT SETS

13 OR 19 PIECE 6-32 — 1/2-13



- 6 Carbon Plug Taps - 4-40,  
6-32, 8-32, 10-24, 10-32, 1/4-20

- 6 HSS Twist Drills - #43, #36,  
#29, #25, #21, #7

PART#	UPC#	WT. PER PKG.	STD. PKG. UM
TDS13	24945	.44	1
TDS19	24951	.67	1



## SCREW EXTRACTOR AND DRILL BIT SET

10 PIECE

118° POINT - Screw Extractors - #1, #2, #3, #4, #5 - Twist Drills - 5/64, 7/64, 5/32, 1/4, 17/64

PART#	UPC#	WT. PER PKG.	STD. PKG. UM
SEDS10	25028	.47	1



## 20 PIECE SHORT ARM HEX KEY SET

SAE: 1/16, 5/64, 3/32, 1/8, 5/32, 3/16, 7/32, 1/4, 5/16, 3/8 INCH

METRIC: 1.5, 2, 2.5, 3, 4, 5, 6, 7, 8, 10 MM

- ABS Storage Case - Dual Case - SAE and Metric in one box - Clear long lasting marking

PART#	UPC#	SIZE	WT. PER PKG.	STD. PKG. UM
HKS1	32717	Inch 1/16"-3/8" - Metric 1.5mm-10mm	1.48	1

## METALLICS KEYHOLE SAW

WOODEN HANDLE



- Designed especially for plasterboard.
- Point sharpened for plunge cuts.
- Make cut-outs for electrical outlets, etc.

PART#	UPC#	LENGTH	BLADE EACH	WT. PER PKG.	STD. PKG. UM
US6	31300	6	1.5 oz	.27	1



## COUNTER SINK BITS SINGLE FLUTE

PART#	UPC#	SIZE	WT. PER PKG.	STD. PKG. UM
CS14	12260	1/4	.03	1
CS38	12261	3/8	.04	1
CS12	12262	1/2	.06	1

OTHER SIZES AND QUANTITIES AVAILABLE BY REQUEST

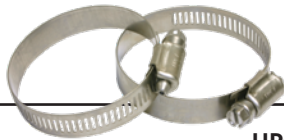

**HOSE CLAMPS**  
STEEL ZINC • 300 SERIES STAINLESS

PART#	UPC#	SIZE	ITEM	WT. PER PKG.	STD. PKG. UM
<b>STEEL ZINC</b>					
MHC6	22906	7/16 - 7/8	hose clamp	.39	10
MHC24	22924	1 1/16 - 2	hose clamp	.50	10
MHC28	22928	1 5/16 - 2 1/2	hose clamp	.53	10
MHC32	22932	1 9/16 - 2 1/2	hose clamp	.58	10
MHC36	22936	1 13/16 - 2 3/4	hose clamp	.58	10
MHC48	22948	2 7/16 - 3 1/2	hose clamp	.70	10
MHC52	22952	2 13/16 - 3 3/4	hose clamp	.72	10
MHC60	22960	3 5/16 - 4 1/4	hose clamp	.77	10
MHC64	22964	3 9/16 - 4 1/2	hose clamp	.80	10
<b>300 SERIES STAINLESS</b>					
HMC6SS	23406	7/16 - 7/8	ss hose clamp	.38	10
HMC23SS	23423	3/4 - 1 3/4	ss hose clamp	.41	10
HMC24SS	23424	1 1/16 - 2	ss hose clamp	.49	10
HMC32SS	23432	1 9/16 - 2 1/2	ss hose clamp	.54	10
HMC36SS	23436	1 13/16 - 2 3/4	ss hose clamp	.58	10
HMC40SS	23440	2 1/16 - 3	ss hose clamp	.61	10
HMC88SS	23488	5 1/16 - 6	ss hose clamp	.96	10
HMC104SS	23534	6 1/16 - 7	ss hose clamp	1.05	10

OTHER SIZES AND QUANTITIES AVAILABLE BY REQUEST



**HOLE GROMMETS**  
BLACK FLEXIBLE VINYL

Installs instantly. Simply snap into hole in panel box, etc., to protect cable.



PART#	UPC#	INSIDE DIA. / OUTSIDE DIA.	HOLE SIZE	PANEL THICKNESS	WT. PER PKG.	STD. PKG. UM
HG14	51130	1/4 X 9/16	.37	3/32	.02	10
HG38	51135	3/8 X 43/64	.49	1/16	.02	10
HG12	51140	1/2 X 55/64	.69	1/16	.04	10
HG58	51145	5/8 X 55/64	.75	1/16	.02	10
HG4764	51150	47/64 X 1 15/64	.99	1/16	.09	10
HG5564	51155	55/64 X 1 13/16	1.00	1/16	.06	10
HG3132	51160	31/32 X 1 - 1/2	1.25	1/16	.13	10
HG2158	25590	1 5/8 X 2	1.63	1/16	.15	10

OTHER SIZES AND QUANTITIES AVAILABLE BY REQUEST

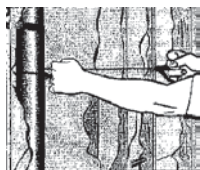

Between Joists

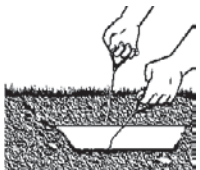

Buried

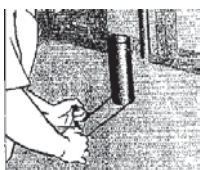

Closet Flanges and Floor

**CABLE SAW**  
FOR PVC PLASTIC - FOR ALL PVC PIPE

**DIRECTIONS:**

1. Secure PVC pipe for cutting. Loop cable around pipe at the location you wish to cut.
2. Apply pressure, while making short back and forth strokes to establish a starting cut or pilot groove in the pipe.
3. Using the middle third of the cable, make longer strokes to completely cut through PVC pipe.

- A WIRE CABLE SAW WITH VINYL COVERED HANDLES.
- SUITABLE FOR CUTTING PVC PLASTIC PIPE.

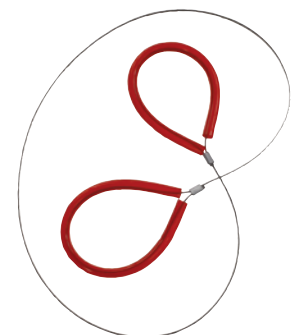

PART#	UPC#	CUTTING LENGTH	OVERALL APPROX. LENGTH	WT. PER PKG.	STD. PKG. UM
MCS26	71616	24	32	.07	1

## NUT AND BOLT GAUGE

STOP GUESSING!



### MISTG1

- Internal thread screw gauge measures inch and metric, course & fine.
- Tap drill chart for inch & metric.

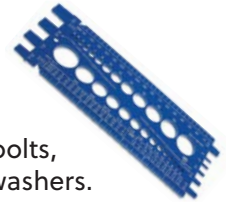

### MNBG1

- Measures inch and metric bolts, nuts, screws, drill bits and washers.
- Inch and metric screw chart.

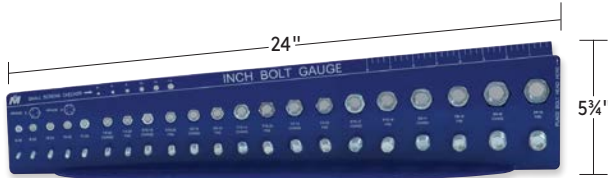

### MBGTDI1 – Inch Bolt Gauge Bin Mount Display

- #6– $\frac{3}{4}$ "
- Ruler
- Sizing Gauge
- Fine – Coarse Thread



### MBGTDM1 – Metric Bolt Gauge Bin Mount Display

- 6mm–16mm
- Sizing Gauge
- Ruler
- Fine – Coarse Thread

PART#	UPC#	DESCRIPTION	WT. PER PKG.	STD. PKG. UM
MNBG1	16450	Nut & Bolt Gauge (Inch & Metric)	.15	1
MISTG1	16452	Internal Thread Gauge (Inch & Metric)	.12	1
MBGTDI1	24556	Bin Mount Bolt Gauge (Inch)	3.13	1
MBGTDM1	24557	Bin Mount Bolt Gauge (Metric)	3.13	1

## SINGLE SIDED AND DOUBLE SIDED ORGANIZERS

Organizer boxes have clear lids to see product inside, and dividers have dovetails to lock in place



- **ORG1** is Single sided and offers 22 storage compartments. Includes 18 dovetail dividers allowing you to customize the size of the compartments.
- **ORG2** is Double sided and offers 32 storage compartments. Includes 24 dovetail dividers.

PART#	UPC#	SIZE	COMPARTMENTS	WT. PER PKG.	STD. PKG. UM
ORG1	34501	13 L x 10 W x 2 H	22	.97	1
ORG2	34502	13 L x 10 W x 3 H	32	1.56	1

OTHER SIZES AND QUANTITIES AVAILABLE BY REQUEST



**LAGMASTER PLUS™**

The Lagmaster Plus™ is the electrician's pole tool. The unique plug-in heads make it the most efficient tool of its kind. It increases safety by keeping your men on the floor. Use it to install ceiling wire, jack chain, threaded rod, smooth rod and overhead screw installation. Power the pole with any 3/8" or 1/2" battery operated or corded drill.



**One pole...many applications!**

Choose from two (2) different adjustable length models.

- MLMT4 Triple 4' (18' ceilings)
- MLMT6 Triple 6' (24' ceilings)

Lagmaster Plus™ wire plug hangs 12 or 9 Gauge wire. No need for ladders, scaffolding or scissor lifts.

Pre-wrapped wire on eye lags require a special plug (pre-wrapped plug).



**Hang it up. (wire plug)**



**Hang Wire.** Move ring into the up position with set screw

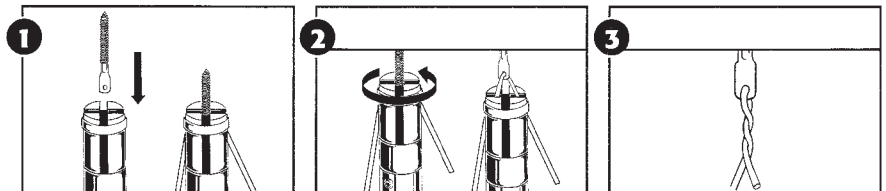

1 Insert the eye lag screw into secured wire plug. Insert the wire through the hole and bend the tails down.

2 Adjust the pole to length and rotate the screw until it is seated. Pull down on the pole so that the wire is caught on the ring.

3 Rotate the pole again to twist the wire. Pull the wire through the plug to complete the installation.

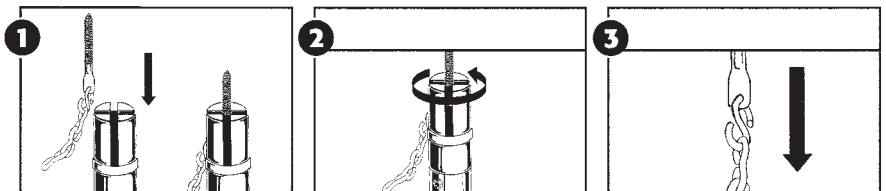

1 Secure a #1 1/2 "S" hook to an acoustical eye lag and to the proper size chain for your job. Insert it into the Lagmaster Plus™.

2 Secure the chain in the magazine so it does not whip when rotating the pole. Now rotate the eye lag screw until it is seated.

3 Lower the Lagmaster Plus™.

**DRIVE IT HOME. (socket plugs)**

Install pre-cut threaded rod from the floor! Works with 3/8" or 1/4" threaded rod up to 10' long. Gets into tight spaces, vaulted ceilings, above stairwells or through ceiling grid easily.

Lagmaster Plus™ open-end socket plug-in heads work with Sammy Super Screws® and HangerMate® screws. Special twist out feature prevents over torquing and stripout even when installing from the floor.

Consult the screw manufacturer's literature for load specs and approvals on the screws.

The Lagmaster Plus™ base is the socket for HangerMate® 3/8" rod screws. The 3/8" socket plug-in works with HangerMate® 1/4" rod screws. The 5/8" socket plug-in works with Sammy Super Screws®.



**One pole...many applications!**





## Hang Threaded Rod:

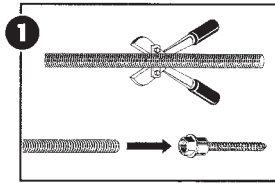

1 Cut threaded rod to length and assemble to appropriate fastener.

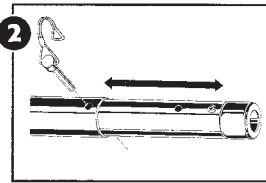

2 Adjust pole tool to length plug in the proper Lagmaster Plus™ head.

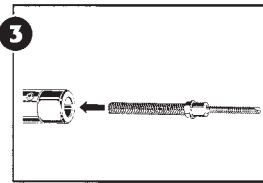

3 Load rod into Lagmaster pole tool. *(The Lagmaster adjusting pin has to be 1/8" below the base or the pin may interfere with the rod.)*

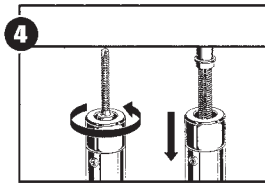

4 Install screw at proper site and pull down to remove the rod from the pole tool. The rod is now ready to receive hanger bracket. *(Patent # 5,154,104)*



Turn your pole tool into a very long screwdriver. This Lagmaster Plus™ plug works with any 1/4" hex driver.

Install smooth rod with a spring clip assembly and screw. The Flash fastener is shown here.

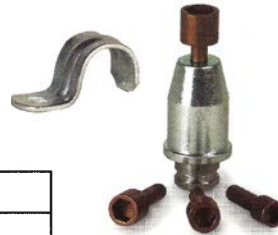

## Overhead Screw Applications: (1/4" hex plug)

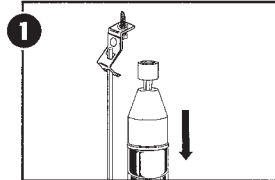

1 Plug in the Lagmaster Plus™ 1/4" hex head and insert the proper 1/4" driver. Adjust the Lagmaster pole tool to length.

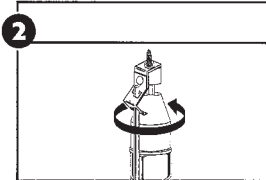

2 Push the smooth rod between the pole and the wire bale on the Lagmaster adjusting pin to keep the rod from whipping while turning the tool.

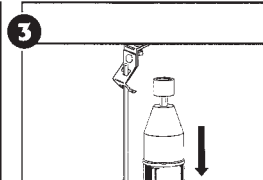

3 Turn in the screw cautiously being careful not to over torque or strip the screw. Remove the tool.



## LAGMASTER PLUS™

PART#	UPC#	DESCRIPTION	WT. PER PKG.	STD. PKG. UM
MLMT4	13329	Triple 4' Installation Tool 18' Ceiling	5.05	1
MLMT6	13331	Triple 6' Installation Tool 24' Ceiling	6.61	1
MLMP18	13332	6' with Adapter Kit and LMP Base	9.00	1
MLMPB1	13336	Lagmaster Plus Base	.50	1
MLMPLUG58	13337	Lagmaster Plus 5/8" open end hex plug	.50	1



## TAP WRENCH T-HANDLE STYLE

PART#	UPC#	CAPACITY	WT. PER PKG.	STD. PKG. UM
TWH1	24970	0 to 1/4	.15	1
TWH2	24975	1/4 to 1/2	.39	1

OTHER SIZES AND QUANTITIES AVAILABLE BY REQUEST



CARBON STEEL TAPS  
PLUG/BOTTOMING/TAPER

	PART#	UPC#	SIZE	USE DRILL SIZE	WT. PER PKG.	STD. PKG. UM	
Plug	440CT	24900	4-40	#43	.05	5	
	632CTE	24907	6-32	#35	.01	1	
	632CT	24905	6-32	#35	.05	5	
	832CT	24910	8-32	#29	.07	5	
	1024CT	24915	10-24	#25	.10	5	
	1032CT	24920	10-32	#21	.10	5	
	1224CTPE	24961	12-24	#16	.04	1	
	1420CT	24925	1/4-20	#7	.15	5	
	1428CTE	26799	1/4-28	#3	.04	1	
	516CT	24930	5/16-18	17/64	.16	5	
	3816CT	24935	3/8-16	5/16	.23	5	
	3824CTE	26861	3/8-24	Q	.35	1	
	71620CTE	26810	7/16-20	25/64	.38	1	
	1213CT	24940	1/2-13	27/64	.46	5	
	1213CTE	24942	1/2-13	27/64	.09	1	
	1220CTE	26816	1/2-20	29/64	.12	1	
	3410CTE	26647	3/4-10	21/32	.12	1	
	Bottoming	440CTBE	24899	4-40	#43	.02	1
		632CTB	24906	6-32	#36	.02	5
		832CTBSS	25002	8-32	#29	.02	1
832CTB		24911	8-32	#29	.02	1	
1024CTBE		24914	10-24	#25	.03	1	
1032CTBE		24923	10-32	#21	.03	1	
1224CTB		24957	12-24	#16	.03	1	
1420CTBE		24927	1/4-20	#7	.04	1	
1428CTBE		26803	1/4-28	#3	.04	1	
51618CTBE		26608	5/16-18	F	.05	1	
51624CTB		26798	5/16-24	I	.06	1	
3816CTBE		26619	3/8-16	5/16	.08	1	
3816GT*		26748	3/8-16	5/16	.08	1	
71614CTB		26626	7/16-14	U	.07	1	
1213CTBE		26630	1/2-13	27/64	.10	1	
1213GT*		26752	1/2-13	27/64	.11	1	
1220CTB		26814	1/2-20	29/64	.10	1	
91612CTB		26634	9/16-12	31/64	.16	1	
91618CTB		26818	9/16-18	33/64	.14	1	
5811CTB		26638	5/8-11	17/32	.18	1	
5818CTB		26822	5/8-18	37/64	.20	1	
3410CTB		26646	3/4-10	21/32	.15	1	
3416CTB		26830	3/4-16	11/16	.30	1	
789CTB		26654	7/8-9	49/64	.44	1	
7814CTB		26838	7/8-14	13/16	.44	1	
18CTB		26662	1-8	7/8	.46	1	
18NPTCT†		26663	1/8	2	.45	1	
112CTB		26846	1-12	59/64	.65	1	
Taper		440CTTE	26590	4-40	#43	.02	1
		632CTTE	26597	6-32	#36	.02	1
	832CTTE	24908	8-32	#29	.02	1	
	1024CTTE	24918	10-24	#25	.03	1	
	1032CTTE	24924	10-32	#21	.03	1	
	1224CTT	24956	12-24	#16	.03	1	
	1420CTTE	24928	1/4-20	#7	.04	1	
	1428CTT	26800	1/4-28	#7	.03	1	
	51618CTTE	26614	5/16-18	17/64	.05	1	
	3816CTTE	26621	3/8-16	5/16	.08	1	
	3824CTT	26858	3/8-24	5/16	.08	1	
	71614CTT	26624	7/16-14	U	.08	1	
	71620CTT	26808	7/16-20	U	.08	1	
	1213CTTE	26629	1/2-13	27/64	.10	1	
	5811CTT	26636	5/8-11	17/32	.05	1	
	5818CTT	26820	5/8-18	37/64	.18	1	
	3410CTT	26644	3/4-10	21/32	.18	1	
	3416CTT	26804	3/4-16	21/32	.30	1	
	789CTT	26652	7/8-9	49/64	.42	1	
	7814CTT	26836	7/8-14	13/16	.47	1	
	18CTT	26660	1-8	7/8	.65	1	
	112CTT	26844	1-12	59/64	.62	1	
	1214PCT†	26704	1/2-14	27/64	.29	1	

\* GUNTAP — †1/8 PIPE TAP — OTHER SIZES AND QUANTITIES AVAILABLE BY REQUEST.



## HIGH SPEED HAND TAPS STEEL

PART#	UPC#	DESCRIPTION	WT. PER PKG.	STD. PKG. UM
632CTHS	35431	6-32 Hi-Spd Hand Tap	.05	5
1032CT2	24919	10-32 High Speed Spiral Point Tap	.05	1
1032CTHS	35430	10-32 C-Steel Hi-Spd Hand Tap	.86	5
1420CTHS	35429	¼-20 C-Steel Hi-Spd Hand Tap	.18	5
1420CT2	16435	¼-20 C-Steel Speed Spiral Point Tap	.14	5
1420CT2T	26684	¼-20 Titanium Spiral Point Tap	.01	1



## COMBINATION HIGH SPEED STEEL DRILL-TAP

PART#	UPC#	SIZE	WT. PER PKG.	STD. PKG. UM
DT632	24094	6-32	.02	1
DT832	24095	8-32	.02	1
DT1024	24122	10-24	.02	1
DT1032	24096	10-32	.02	1
DT1420	24097	¼-20	.03	1
DT3816	24098	¾-16	.08	1
DT1213	24099	½-13	.13	1

OTHER SIZES AND QUANTITY AVAILABLE UPON REQUEST



## POWER BIT EXTENSIONS

- Hex wrench included
- Two set screws

PART#	UPC#	DIAMETER	LENGTH	WT. EACH	STD. PKG. UM
BE1418	24875	¼	18	.48	1
BE5618	24880	5/16	18	1.50	1
BE7612	24885	7/16	12	.86	1
BE7618	24890	7/16	18	1.20	1
BE7624	24891	7/16	24	1.56	1

OTHER SIZES AND QUANTITIES AVAILABLE BY REQUEST



## SHIP AUGER WOOD BITS HEX SHANK

- Single twist with single cutter and side lip
- Machine ground hollows, deep throat for fast chip removal
- Heat treated tool steel for strength and long life
- 7/16 shank for 3 jaw chucks
- Self-feed screw point
- Cuts nails

PART#	UPC#	BORE DIAMETER	LENGTH	WT. PER PKG.	STD. PKG. UM
AS916	24600	9/16	8	.25	1
AS588	31348	5/8	8	.30	1
AS11168	24602	11/16	8	.31	1
AS34	24603	¾	8	.43	1
AS1316	24604	13/16	8	.42	1
AS78	24605	7/8	8	.54	1
AS1516	24606	15/16	8	.40	1
AS1	24607	1	8	.55	1
AS118	24608	1 1/8	8	.79	1
AS114	24609	1 ¼	8	.55	1
AS138	24610	1 3/8	8	.82	1
AS112	24611	1 ½	8	1.22	1
AL38	24614	3/8	18	.57	1
AL916	24615	9/16	18	.65	1

OTHER SIZES AND QUANTITY AVAILABLE UPON REQUEST



CONTINUED  
SHIP AUGER WOOD BITS  
HEX SHANK

- Single twist with single cutter and side lip
- Machine ground hollows, deep throat for fast chip removal
- Heat treated tool steel for strength and long life
- $\frac{7}{16}$  shank for 3 jaw chucks
- Self-feed screw point
- Cuts nails

PART#	UPC#	BORE DIAMETER	LENGTH	WT. PER PKG.	STD. PKG. UM
AL58	24616	$\frac{5}{8}$	18	.72	1
AL1116	24617	$\frac{11}{16}$	18	.87	1
AL34	24618	$\frac{3}{4}$	18	.71	1
AL1316	24619	$\frac{13}{16}$	18	1.08	1
AL78	24620	$\frac{7}{8}$	18	1.24	1
AL1516	24621	$\frac{15}{16}$	18	1.36	1
AL1	24622	1	18	1.54	1
AL118	24623	$1\frac{1}{8}$	18	1.42	1
AL114	24624	$1\frac{1}{4}$	18	2.35	1
AL138	24625	$1\frac{3}{8}$	18	2.94	1
AL112	24626	$1\frac{1}{2}$	18	3.30	1

OTHER SIZES AND QUANTITY AVAILABLE UPON REQUEST



QUIK-BIT FLAT WOOD BORING BITS  
PACKED IN VINYL POUCH  
*E-Z to display packaging*

PART#	UPC#	SIZE	LENGTH	WT. PER PKG.	STD. PKG. UM
QB1	24701	$\frac{1}{4}$	6	.05	1
QB2	24702	$\frac{5}{16}$	6	.06	1
QB3	24703	$\frac{3}{8}$	6	.09	1
QB4	24704	$\frac{7}{16}$	6	.06	1
QB5	24705	$\frac{1}{2}$	6	.09	1
QB6	24706	$\frac{9}{16}$	6	.09	1
QB7	24707	$\frac{5}{8}$	6	.09	1
QB8	24708	$\frac{11}{16}$	6	.09	1
QB9	24709	$\frac{3}{4}$	6	.09	1
QB10	24710	$\frac{13}{16}$	6	.10	1
QB11	24711	$\frac{7}{8}$	6	.10	1
QB12	24712	$\frac{15}{16}$	6	.11	1
QB13	24713	1	6	.13	1
QB14	24714	$1\frac{1}{8}$	6	.13	1
QB15	24715	$1\frac{1}{4}$	6	.13	1
QB16	24716	$1\frac{3}{8}$	6	.14	1
QB17	24717	$1\frac{1}{2}$	6	.14	1
QB20	24720	$\frac{1}{4}$	16	.18	1
QB21	24721	$\frac{5}{16}$	16	.18	1
QB22	24722	$\frac{3}{8}$	16	.27	1
QB23	24723	$\frac{7}{16}$	16	.31	1
QB24	24724	$\frac{1}{2}$	16	.33	1
QB25	24725	$\frac{9}{16}$	16	.38	1
QB26	24726	$\frac{5}{8}$	16	.28	1
QB27	24727	$\frac{11}{16}$	16	.30	1
QB28	24728	$\frac{3}{4}$	16	.28	1
QB29	24729	$\frac{7}{8}$	16	.32	1
QB30	24730	$\frac{15}{16}$	16	.53	1
QB31	24731	1	16	.30	1
QB32	24732	$1\frac{1}{8}$	16	.53	1
QB33	24733	$1\frac{1}{4}$	16	.43	1
QB34	24734	$1\frac{3}{8}$	16	.55	1
QB35	24735	$1\frac{1}{2}$	16	.46	1

OTHER SIZES AND QUANTITY AVAILABLE UPON REQUEST

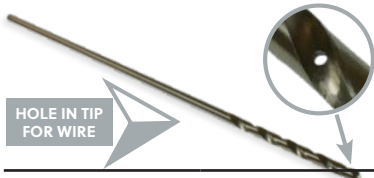

## BELL HANGER DRILLS

- Specifically designed for wood/masonry product construction
- For all telephone, electrical, small wire, protective alarm and cable T.V. uses
- Resists damage during drilling if metal is encountered

PART#	UPC#	DIAMETER	LENGTH	SHANK DIAMETER	WT. PER PKG.	STD. PKG. UM
BHD14	26057	1/8	12	1/8	.05	1
BHD1	26000	1/4	12	1/4	.16	1
BHD2	26005	5/16	12	5/16	.16	1
BHD3	26010	3/8	12	3/8	.17	1
BHD4	26015	1/2	12	1/2	.18	1
BHD15	26058	3/16	18	3/16	.18	1
BHD5	26020	1/4	18	1/4	.26	1
BHD6	26025	5/16	18	5/16	.40	1
BHD7	26030	3/8	18	3/8	.56	1
BHD8	26035	1/2	18	3/8	.90	1
BHD9	26040	1/4	24	1/4	.35	1
BHD10	26045	5/16	24	5/16	.69	1
BHD11	26050	3/8	24	3/8	.70	1
BHD12	26055	1/2	24	1/2	.75	1

### CARBIDE TIP WITH FISH HOLE FOR MASONRY

BHDM1	26001	1/4	13	1/4	.16	1
BHDM5	26021	1/4	18	1/4	.26	1
BHDM9	26041	1/4	24	1/4	.35	1
BHDM2	26006	5/16	13	5/16	.16	1
BHDM6	26026	5/16	18	5/16	.40	1
BHDM10	26046	5/16	24	5/16	.69	1
BHDM3	26011	3/8	13	3/8	.17	1
BHDM7	26031	3/8	18	3/8	.56	1
BHDM11	26051	3/8	24	3/8	.70	1
BHDM16	26059	3/8	30	3/8	.87	1
BHDM4	26016	1/2	13	3/8	.18	1
BHDM8	26036	1/2	18	3/8	.90	1
BHDM12	26056	1/2	24	3/8	.75	1
BHDM17	26060	1/2	30	3/8	.94	1
BHDM18	26062	3/4	13	1/2	.35	1
BHDM19	26063	3/4	18	1/2	.48	1

OTHER SIZES AND QUANTITY AVAILABLE UPON REQUEST



## SDS-PLUS HAMMER DRILLS

PART#	UPC#	DIAMETER	LENGTH	WT. PER PKG.	STD. PKG. UM
SDS53265	24565	5/32	6 1/4	.10	1
SDS31645	24101	3/16	4 1/2	.08	1
SDS31665	24102	3/16	6 1/2	.10	1
SDS3168	24103	3/16	8 1/4	.10	1
SDS73265	24297	7/32	6 1/4	.08	1
SDS1445	24104	1/4	4 1/2	.09	1
SDSB1445	24326	1/4	4 1/2	2.25	25
SDS1465	24106	1/4	6 1/4	.11	1
SDSB1465	24331	1/4	6 1/2	2.15	25
SDS149	24107	1/4	8 1/4	.14	1
SDS1412	24301	1/4	14	.16	1
SDS1420	24304	1/4	20	.22	1
SDS5166	20884	5/16	6 1/4	.13	1
SDS3865	24108	3/8	6 1/4	.16	1
SDS388	24117	3/8	8 1/4	.20	1
SDS389	24109	3/8	9	.20	1
SDS3812	24306	3/8	12 1/4	.27	1
SDS1265	24111	1/2	6 1/4	.22	1
SDSB1265	24336	1/2	6 1/4	5.60	25

\*Spline Drive – OTHER SIZES AND QUANTITY AVAILABLE UPON REQUEST

CONTINUED ON NEXT PAGE  
[www.metallics.us](http://www.metallics.us)

CONTINUED

SDS-PLUS HAMMER DRILLS



PART#	UPC#	DIAMETER	LENGTH	WT. PER PKG.	STD. PKG. UM
SDS129	24112	1/2	10 1/4	.34	1
SDS1212	24311	1/2	12 1/4	.40	1
SDS1218	24312	1/2	18	.67	1
SDS1224	24313	1/2	24	.73	1
SDS9166	24575	9/16	6 1/4	.24	1
SDS5865	24113	5/8	6 1/2	.26	1
SDS589	24114	5/8	8	.31	1
SDS111610	24585	11/16	12	.45	1
SDS348	24316	3/4	8	.44	1
SDS788	24321	7/8	8	.76	1
SDS18	21218	1	8	.87	1
*SDS1229SPD	24118	1/2	29	.88	1
*SDS1236SPD	24119	1/2	36	1.09	1

\*Spline Drive – OTHER SIZES AND QUANTITY AVAILABLE UPON REQUEST



SD34

SD12

MULTI STEP DRILLS

Self starting tip eliminates need for pilot hole drilling

PART#	UPC#	DESCRIPTION	WT. PER PKG.	STD. PKG. UM
SD14138	24078	1/4 - 3/8 2 FLUTE, 10 STEP	.06	1
SD12	24080	1/8 - 1/2 2 FLUTE, 13 STEP	.06	1
SD34	24082	1/4 - 3/4 2 FLUTE, 9 STEP	.10	1
SD78	24084	7/8 - 1 1/8 3 STEP	.16	1

3 SET COMBO PACK

SDCP3	24088	1/8 - 1/2 2 FLUTE, 13 STEP	.37	1
		1/4 - 3/4 2 FLUTE, 9 STEP		
		7/8 - 1 1/8 3 STEP		

OTHER SIZES AND QUANTITIES AVAILABLE BY REQUEST



SD131812

SD1231678

SD631612

SD12716118

SD91434

SD278118

SPIRAL FLUTE STEP DRILL BITS

Individually Packaged

PART#	UPC#	ITEM	WT. PER PKG.	STD. PKG. UM
SD131812	27066	13 Step 1/8" - 1/2"	.10	1
SD631612	27067	6 Step 3/16" - 1/2"	.10	1
SD91434	27071	9 Step 1/4" - 3/4"	.15	1
SD1231678	27077	12 Step 3/16" - 7/8"	.15	1
SD12716118	27078	12 Step 7/16" - 1 1/8"	.30	1
SD278118	27055	2 Step 7/8" - 1 1/8"	.25	1



**BULK CARBIDE MASONRY DRILL PACKS**

*We know the drill. You need it, we have it!*



PART#	UPC#	DIAMETER	LENGTH	SHANK DIAMETER	WT. PER PKG.	STD. PKG. UM
BFRB11	37049	3/16	4	9/64	2.06	100
BFRB22	37066	3/16	6	9/64	2.50	50
BFRB12	37050	1/4	4	1/4	3.43	100
BFRB13	37054	1/4	6	1/4	3.53	50
BFRB13100	37040	1/4	6	1/4	7.06	100
BFRB14	37055	5/16	4	1/4	3.08	75
BFRB16	37060	3/8	4	1/4	3.14	50
BFRB38100	37046	3/8	6	1/4	11.00	100
BFRB21	37065	1/2	4	1/4	2.64	25
BFRB20	37070	1/2	6	3/8	4.73	25
BFRB2060	37043	1/2	6	3/8	12.00	60
BFRB58	37083	5/8	6	1/2	12.40	40

OTHER SIZES AND QUANTITIES AVAILABLE BY REQUEST

**CARBIDE MASONRY DRILLS**



- Specially designed spirals for fast dust removal
- Slow spiral drills can be used with either rotary or hammer drills in hard brick, sandstone, bluestone, terracotta block and hard concrete

PART#	UPC#	DIAMETER	LENGTH	SHANK DIAMETER	WT. PER PKG.	STD. PKG. UM
<b>SLOW SPIRAL</b>						
BFR10	24100	1/8	3	3/32	.02	1
BFR9	24092	5/32	6	5/32	.02	1
BFR2	24090	3/16	4	1/8	.02	1
BFR11	24105	3/16	4	9/64	.03	1
BFR22	24151	3/16	6	9/64	.04	1
BFR12	24110	1/4	4	1/4	.04	1
BFR13	24115	1/4	6	1/4	.06	1
BFR14	24120	5/16	4	1/4	.05	1
BFR15	24125	5/16	6	1/4	.08	1
BFR16	24130	3/8	4	1/4	.07	1
BFR17	24135	3/8	6	1/4	.11	1
BFR18	24140	7/16	6	1/4	.15	1
BFR21	24145	1/2	4	1/4	.11	1
BFR19	24150	1/2	6	1/4	.20	1
BFR20	24155	1/2	6	3/8	.20	1
BFR25	24158	7/8	6	1/2	.57	1
<b>FAST SPIRAL</b>						
BFRS14	37163	5/16	4	1/4	.05	1
BFRS145	37246	5/16	4	1/4	.25	5
BFRS16	37165	3/8	4	1/4	.07	1
BFRS165	37266	3/8	4	1/4	.35	5
BFRS21	37170	1/2	4	1/4	.09	1
BFRS215	37291	1/2	4	1/4	.45	5
<b>MULTIPURPOSE</b>						
MPD1	37491	1/8	3	3/32	.01	1
MPD3	37493	3/16	3 1/2	1/8	.03	1

OTHER QUANTITIES AVAILABLE UPON REQUEST



FLEXIBLE FISH-BITS

- Unique flexible self-feeding bits up to 72" long suitable for drilling holes with the length of wall cavities and through hidden studs with no damage to wallboard plaster or any exterior finish.
- Bit has hole at tip and the shank which allows you to fish wire

PART#	UPC#	DESCRIPTION	SIZE	SHANK DIAMETER	WT. PER PKG.	STD. PKG. UM
MFB1454	26455	FISH-BIT	¼ x 54	3/16	.65	1
MFB3854	26459	FISH-BIT	3/8 x 54	3/16	.65	1
MFB1254	26451	FISH-BIT	½ x 54	3/16	.65	1
MFB1472	26457	FISH-BIT	¼ x 72	3/16	.75	1
MFB3872	26461	FISH-BIT	3/8 x 72	3/16	.75	1
MFB1272	26453	FISH-BIT	½ x 72	3/16	.65	1
MSG1	26445	Steering Guide Tool	-	-	.47	1

OTHER SIZES AND QUANTITIES AVAILABLE BY REQUEST

EXTRA LONG MASONRY DRILLS



PART#	UPC#	DIAMETER	LENGTH	SHANK DIAMETER	WT. PER PKG.	STD. PKG. UM
BTT1	24185	¼	12	¼	.15	1
BTT9	24225	¼	18	¼	.22	1
BTT2	24190	5/16	12	¼	.22	1
BTT10	24230	5/16	18	¼	.34	1
BTT3	24195	3/8	12	3/8	.29	1
BTT11	24235	3/8	18	3/8	.45	1
BTT18	24263	3/8	24	3/8	.65	1
BTT17	24262	7/16	13	3/8	.43	1
BTT4	24200	½	12	3/8	.44	1
BTT12	24240	½	18	3/8	.64	1
BTT22	24160	9/16	6	3/8	.31	1
BTT23	24165	5/8	6	3/8	.31	1
BTT5	24205	5/8	12	3/8	.62	1
BTT13	24245	5/8	18	½	.94	1
BTT24	24170	¾	6	½	.47	1
BTT6	24210	¾	12	½	.91	1
BTT14	24250	¾	18	½	1.37	1
BTT25	24175	7/8	6	½	.58	1
BTT7	24215	7/8	12	½	1.24	1
BTT15	24255	7/8	18	½	1.79	1
BTT26	24180	1	6	½	.75	1
BTT8	24220	1	12	½	1.53	1
BTT16	24260	1	18	½	2.50	1

OTHER SIZES AND QUANTITIES AVAILABLE BY REQUEST



FLOOR FLANGE  
GALVANIZED CAST IRON

PART#	UPC#	PIPE SIZE	ANCHOR HOLE	WT. PER PKG.	STD. PKG. UM
MFF25	16201	½	¼	.27	1
MFF75	16202	¾	¼	.49	1
MFF100	16203	1	¼	.65	1
MFF125	16204	1¼	¼	.88	1
MFF150	16205	1½	¼	1.16	1
MFF200	16206	2	5/16	1.55	1

OTHER SIZES AND QUANTITIES AVAILABLE BY REQUEST



PART #:	PAGE						
1008	139	00TP30	61	125R2B	210	1PSC150	186
1410	140	00TP40	61	125R3B	210	1PSC200	186
1411	140	10010B	210	125ROS	186	1PSC200E	186
5810	144	10010X	209	125RTS	186	1PSC250	186
681032	185	1004B	210	125SNKO	193	1PSC300	186
681032	202	1005B	210	1401ST	141	1PSC350	186
1513910	128	1006B	210	1402ST	141	1PSC38	186
1591910	128	1008B	210	1403ST	141	1PSC400	186
00010B	210	1008X	209	1405ST	141	1PSC50	186
0001B	210	100EOS	187	1406M	140	1PSC75	186
0004B	210	100ETS	187	1406ST	141	200EOS	187
0006B	210	100KOS	194	1407M	140	200ETS	187
0008B	210	100KOSG	194	1407ST	141	200KOS	194
000P0B	209	100PIB	209	1408B	210	200KOSG	194
000P1B	209	100PIX	209	1408M	140	200ROS	186
000P1X	209	100P2B	209	1408ST	141	200RTS	186
000P2B	209	100P2X	209	1409M	140	200SNKO	193
000P2BB	209	100P3B	209	1409ST	141	250KOS	194
000P2R	209	100P3X	209	1409V	140	250KOSG	194
000P2X	209	100R1B	210	140PIB	209	250ROS	186
000P3B	209	100R2B	210	140P2B	209	250RTS	186
000P3X	209	100R3B	210	140P3B	209	300KOS	194
000R1B	210	100ROS	186	140R1B	210	300KOSG	194
000R2B	210	100RTS	186	140R2B	210	300ROS	186
000R2X	209	100SNKO	193	140R3B	210	300RTS	186
000R3B	210	1024CT	218	1420CT	218	3410CTB	218
00110B	210	1024CTBE	218	1420CT2	219	3410CTE	218
00110X	209	1024CTTE	218	1420CT2T	219	3410CTT	218
00112B	210	1032CT	218	1420CTBE	218	3416CTB	218
0013B	210	1032CT2	219	1420CTHS	219	3416CTT	218
0014B	210	1032CTBE	218	1420CTTE	218	350KOS	194
0016B	210	1032CTHS	219	1428CTBE	218	350KOSG	194
0016X	209	1032CTTE	218	1428CTE	218	350ROS	186
0018B	210	110R2B	210	1428CTT	218	350RTS	186
0018X	209	112CTB	218	15065M	136	3816CT	218
001P2B	209	112CTT	218	1506M	136	3816CTBE	218
00HP16B	61	1213CT	218	1507B	136	3816CTTE	218
00HP18B	61	1213CTBE	218	150EOS	187	3816GT	218
00HP32B	61	1213CTE	218	150ETS	187	3824CTE	218
00HP964B	61	1213CTTE	218	150KOS	194	3824CTT	218
00SP10B	61	1213GT	218	150KOSG	194	400KOS	194
00SP10B	210	1214PCT	218	150ROS	186	400KOSG	194
00SP12B	61	1220CTB	218	150RTS	186	400ROS	186
00SP12B	210	1220CTE	218	150SNKO	193	400RTS	186
00SP14B	61	1224CTB	218	1512B	136	41SQ	210
00SP14B	210	1224CTPE	218	1512CB	136	440CT	218
00SP4B	61	1224CTT	218	1512V	136	440CTBE	218
00SP4B	210	12510B	210	1608B	210	440CTTE	218
00SP6B	61	12512B	210	160PIB	209	50EOS	187
00SP6B	210	1254B	210	160P2B	209	50ETS	187
00SP8B	61	1256B	210	160P3B	209	50KOS	194
00SP8B	210	1258B	210	160R1B	210	50KOSG	194
00TP06	61	125EOS	187	160R2B	210	50ROS	186
00TP08	61	125ETS	187	160R3B	210	50RTS	186
00TP09	61	125KOS	194	180R2B	210	50SNKO	193
00TP10	61	125KOSG	194	18CTB	218	51618CTBE	218
00TP15	61	125P1B	209	18CTT	218	51618CTTE	218
00TP20	61	125P2B	209	18NPTCT	218	51624CTB	218
00TP25	61	125P3B	209	1PSC100	186	516CT	218
00TP27	61	125R1B	210	1PSC125	186	5811CTB	218
						5811CTT	218
						5818CTB	218
						5818CTT	218
						632CT	218
						632CTB	218
						632CTE	218
						632CTHS	219
						632CTTE	218
						71614CTB	218
						71614CTT	218
						71620CTE	218
						71620CTT	218
						75EOS	187
						75ETS	187
						75KOS	194
						75KOSG	194
						75ROS	186
						75RTS	186
						75SNKO	193
						7814CTB	218
						7814CTT	218
						789CTB	218
						789CTT	218
						832CT	218
						832CTB	218
						832CTBSS	218
						832CTTE	218
						91612CTB	218
						91618CTB	218
						<b>A</b>	
						AL1	220
						AL1116	220
						AL112	220
						AL114	220
						AL118	220
						AL1316	220
						AL138	220
						AL1516	220
						AL34	220
						AL38	219
						AL58	220
						AL78	220
						AL916	219
						ALSD	176
						AS1	219
						AS11168	219
						AS112	219
						AS114	219
						AS118	219
						AS1316	219
						AS138	219
						AS1516	219
						AS34	219
						AS588	219
						AS78	219
						AS916	219
						ASB0	193
						ASB1	193
						ASB2	193
						ASB3	193
						ASB4	193
						ASB5	193
						ASB6	193
						ASB7	193
						ASB8	193
						ATEK175SD	176
						<b>B</b>	
						BA2M	153
						BBH127	117
						BBH37	117
						BBH38	117
						BBH50	116
						BBH52	116
						BBH90	117
						BC14	169
						BC14SS	169
						BC38	169
						BC38C	169
						BCK29	202
						BCKE29	202
						BE1418	219
						BE5618	219
						BE7612	219
						BE7618	219
						BE7624	219
						BFR10	223
						BFR11	223
						BFR12	223
						BFR13	223
						BFR14	223
						BFR15	223
						BFR16	223
						BFR17	223
						BFR18	223
						BFR19	223
						BFR2	223
						BFR20	223
						BFR21	223
						BFR22	223
						BFR25	223
						BFR9	223
						BFRB11	223
						BFRB12	223
						BFRB13	223
						BFRB13100	223
						BFRB14	223
						BFRB16	223
						BFRB20	223
						BFRB2060	223
						BFRB21	223
						BFRB22	223
						BFRB38100	223
						BFRB58	223
						BFRS14	223
						BFRS145	223
						BFRS16	223

When Searching Stock # Drop "J"

[www.metallics.us](http://www.metallics.us)

# QUICK REFERENCE PRODUCT INDEX

PART #:	PAGE				
BFRS165.....	223	BHC81G.....	99	BTJ2.....	170
BFRS21.....	223	BHC81PL.....	98	BTJ3.....	170
BFRS215.....	223	BHC82.....	97	BTJ3SS.....	170
BHC103.....	96	BHC82G.....	99	BTJ4.....	170
BHC103G.....	99	BHC83PL.....	98	BTJ6G.....	170
BHC105.....	97	BHC85.....	97	BTJ7.....	170
BHC107.....	97	BHC86M.....	96	BTJ7SS.....	170
BHC108.....	97	BHC87.....	97		
BHC111PL.....	98	BHC88M.....	95	<b>C</b>	
BHC12612G.....	99	BHC91.....	97	CA5051.....	199
BHC145.....	97	BHCK1213.....	94	CB38.....	120
BHC18.....	95	BHCK1420.....	94	CB5M.....	120
BHC183G.....	99	BHCK3816.....	94	CB8.....	121
BHC19.....	95	BHD1.....	221	CB9.....	121
BHC23M.....	95	BHD10.....	221	CB9G.....	121
BHC23PLV.....	97	BHD11.....	221	CD1.....	128
BHC24V.....	96	BHD12.....	221	CD1.....	211
BHC25M.....	95	BHD14.....	221	CD2.....	128
BHC26CC.....	96	BHD15.....	221	CD2.....	211
BHC2M.....	95	BHD2.....	221	CD3.....	128
BHC33G.....	99	BHD3.....	221	CD3.....	211
BHC33V.....	96	BHD4.....	221	CD5.....	128
BHC3410G.....	99	BHD5.....	221	CD5.....	211
BHC35CC.....	96	BHD6.....	221	CD6.....	128
BHC38.....	96	BHD7.....	221	CD6.....	211
BHC39.....	96	BHD8.....	221	CD7.....	128
BHC3V.....	95	BHD9.....	221	CD7.....	211
BHC41.....	96	BHDM1.....	221	CD8.....	128
BHC44M.....	95	BHDM10.....	221	CD8.....	211
BHC455M.....	95	BHDM11.....	221	CDS1.....	191
BHC45CB.....	95	BHDM12.....	221	CDS2.....	191
BHC45M.....	95	BHDM16.....	221	CDS3.....	191
BHC45PLV.....	97	BHDM17.....	221	CDS5.....	191
BHC46M.....	96	BHDM18.....	221	CDS6.....	191
BHC47C.....	96	BHDM19.....	221	CG20.....	183
BHC47V.....	96	BHDM2.....	221	CG202500.....	183
BHC586.....	97	BHDM3.....	221	CG20500.....	183
BHC59CB.....	95	BHDM4.....	221	CNN1024.....	79
BHC59V.....	95	BHDM5.....	221	CNN1024.....	188
BHC64V.....	96	BHDM6.....	221	CNN1024K.....	79
BHC68.....	96	BHDM7.....	221	CNN1024K.....	188
BHC69G.....	99	BHDM8.....	221	CNN1032.....	79
BHC70.....	96	BHDM9.....	221	CNN1032.....	188
BHC70PL.....	98	BLS10SS.....	122	CNN1032K.....	79
BHC71G.....	99	BLS12GB.....	123	CNN1032K.....	188
BHC73.....	96	BLS12GM.....	123	CNN1032M.....	79
BHC73G.....	99	BLS26G.....	123	CNN1032M.....	188
BHC73PL.....	98	BLS27PLB.....	122	CNN1224.....	79
BHC74.....	97	BLS3410G.....	124	CNN1224.....	188
BHC7612.....	97	BLS43M.....	122	CNN1224K.....	79
BHC7612PL.....	98	BLS48B.....	122	CNN1224K.....	188
BHC77.....	97	BLS48PLB.....	122	CPIA.....	181
BHC77PL.....	98	BLS54.....	122	CP3S.....	181
BHC78.....	97	BLS586G.....	124	CP4S.....	181
BHC7810G.....	99	BLS588G.....	124	CPD1M.....	55
BHC79.....	97	BLS59PLB.....	122	CPD1V.....	55
BHC79PL.....	98	BLS8SS.....	122	CPD2M.....	55
BHC80.....	97	BLS90G.....	124	CPD2V.....	55
BHC80G.....	99	BSC14112M.....	21	CPD3M.....	55
BHC81.....	97	BTJ1.....	170		

## D

DCA1.....	208	DWC1M.....	50
DCS1.....	199	DWC3B.....	50
DCS1V.....	199	DWC3M.....	50
DEA34.....	144	DWC4B.....	50
DEA38M.....	144	DWC4M.....	50
DHS5.....	212	DWC4V.....	50
DIA12M.....	142	DWC5B.....	50
DIA12T.....	143	DWC5M.....	50
DIA14CB.....	142	DWC6B.....	50
DIA14M.....	142	DWC75B.....	50
DIA14T.....	143	DWC7B.....	50
DIA34B.....	142	DWC9B.....	50
DIA34T.....	143	DWC9M.....	50
DIA38CB.....	142	DWD22862.....	179
DIA38M.....	142	DWS10B.....	51
DIA38T.....	143	DWS11B.....	51
DIA58C.....	142	DWS1B.....	51
DIA58T.....	143	DWS1M.....	51
DLC1.....	174	DWS1V.....	51
DLC1S.....	174	DWS3B.....	51
DLC2.....	174	DWS3M.....	51
DLC2/0.....	174	DWS3MD.....	50
DLC3.....	174	DWS3MD.....	50
DLC3S.....	174	DWS3V.....	51
DLC4.....	174	DWS4B.....	50
DS1525M.....	33	DWS4BD.....	50
DS152B.....	33	DWS4M.....	51
DS1715M.....	34	DWS4MD.....	50
DS172M.....	34	DWS4MD.....	50
DS1735M.....	34	DWS55B.....	51
DS1745M.....	34	DWS5B.....	51
DS174M.....	34	DWS5BD.....	50
DS178M.....	34	DWS5BD.....	50
DS179M.....	34	DWS5M.....	51
DS179V.....	34	DWS5MD.....	50
DS181B.....	33	DWS5MD.....	50
DS182B.....	33	DWS5V.....	51
DS183M.....	33	DWS6B.....	51
DS184B.....	33	DWS6M.....	51
DS184M.....	33	DWS75B.....	51
DS185B.....	33	DWS7B.....	51
DS185M.....	33	DWS7M.....	51
DS80M.....	33	DWS93B.....	51
DS835M.....	34	DWS9B.....	51
DSK10.....	65	DWS9M.....	51
DSK12.....	65	DWS9V.....	51
DSK8.....	65	DWSK1.....	67
DT1024.....	219	DWSR1B.....	52
DT1032.....	219	DWSR1M.....	52
DT1213.....	219	DWSR3B.....	52
DT1420.....	219	DWSR3M.....	52
DT3816.....	219	DWSR4B.....	52
DT632.....	219	DWSR4M.....	52
DT832.....	219	DWSR5B.....	52
DWC10B.....	50	DWSR5M.....	52
		DWSR6B.....	52
		DWSR6M.....	52
		DWSR7B.....	52
		DWSR7M.....	52

PART #:	PAGE						
DWSR9B	52	G5HC146	102	GDS7V	53	HSD11	205
DWSR9M	52	G5HC153	102	GDSK1	67	HSD116E	203
<b>E</b>		G5HC154	102	GS20	182	HSD11E	203
EB10	171	G5HC155	102	GS20500	182	HSD12	205
EB12	171	G5HC156	102	GSH1510M	182	HSD1212E	203
EB13	171	G5HC2M	100	GSH19	182	HSD12E	203
EB14SS	171	G5HC38	101	GSH20	182	HSD13	205
EB16	171	G5HC39	101	GSH20500	182	HSD13E	203
EB17	171	G5HC40	101	GSH205M	182	HSD14	205
EB18	171	G5HC48	101	GSH208M	182	HSD14E	203
EB19	171	G5HC63B	102	GSH21	182	HSD15	205
EC44B	177	G5HC70	102	GSH21500	182	HSD15E	203
EC44M	177	G5HC72D	100	GSH21M	182	HSD16	205
EVBK100	61	G5HC74	102	GSH22	183	HSD16E	203
EZSTPL1C	196	G5HC76	102	GSH22500	183	HSD16R	205
EZSTPL2M	196	G5HC77D	100	GSH23	182	HSD16RE	203
EZSTPL5C	196	G5HC80	102	GSH2310M	182	HSD17	205
EZT1J/jar	165	G5HC82	102	GSH23500	182	HSD17E	203
EZT1K/box	165	G5HTB47V	103	GSH24	182	HSD18	205
<b>F</b>		G5HTB63	104	<b>H</b>		HSD18E	203
FD8234	141	G5HTB66	104	HAB12B	175	HSD19	206
FHC1	174	G5HTB68	104	HAB12PLB	175	HSD19E	203
FHK1	174	G5HTB72	104	HAB13PLB	175	HSD1E	203
FHK2	174	G5HTB73	104	HAB15B	175	HSD2	205
FMI136	18	G5HTB75	104	HAB15PLB	175	HSD20	206
FMI37	18	G5HTB77	104	HAB17	175	HSD20E	203
FM39SS	18	G5HTB79	104	HABD10	175	HSD20R	206
FMK632	63	G5HTB80	104	HABD12	175	HSD20RE	203
FMK832	63	G5N165V	71	HABD14	175	HSD21	206
FMKP632	63	G5N166V	71	HABD9	175	HSD21E	203
FMKP832	63	G8HC340	106	HABD14	175	HSD22	206
FSCS1	128	G8HC343	106	HABD9	175	HSD22E	203
FSCS10	128	G8HC34312	106	HDT14	61	HSD23	206
FSCS2	128	G8HC344	106	HDT2	153	HSD23E	203
FSCS20	128	G8HC345	106	HG12	214	HSD24	206
FSCS3	128	G8HC346	106	HG14	214	HSD24E	203
FSCS30	128	G8HC34712	106	HG2158	214	HSD24R	206
FSCS40	128	G8HC441	106	HG3132	214	HSD24RE	203
FST100	198	G8HC442	106	HG38	214	HSD25	206
FST100I	198	G8HC484	106	HG4764	214	HSD25E	203
FST100SS	197	G8HC58312	106	HG5564	214	HSD26	206
FST300	198	G8HC584	106	HG58	214	HSD26E	203
FST350	198	G8HC58412	106	HK1	130	HSD27	206
FST40	198	G8HC751	106	HK1	212	HSD27E	203
FST40I	198	G8HC75112	106	HKS1	213	HSD28	206
FST40SS	197	G8HC75114	106	HMC104SS	214	HSD28E	203
FWK10	86	G8HC75134	106	HMC23SS	214	HSD28R	206
FWP22M	47	G8HC752	106	HMC24SS	214	HSD28RE	203
FWP43V	48	G8HC75214	106	HMC32SS	214	HSD29	205
<b>G</b>		G8HC75234	106	HMC36SS	214	HSD29E	203
G5HC13P	102	G8HC754	106	HMC40SS	214	HSD29R38E	203
G5HC143	102	G8HCF83	106	HMC6SS	214	HSD29T	203
G5HC144	102	G8WW82M	83	HMC88SS	214	HSD2E	203
G5HC145	102	GDS25B	53	HR750	192	HSD3	205
		GDS4M	53	HR770	192	HSD31	205
		GDS55B	53	HR780	192	HSD34E	203
		GDS5M	53	HSD1	205	HSD3E	203
		GDS6M	53	HSD10	205	HSD4	205
		GDS6V	53	HSD10E	203	HSD4964E	203
		GDS7M	53	HSD10T	203	HSD4E	203
						HSD5	205
						HSD50RE	203
						HSD58E	203
						HSD5E	203
						HSD6	205
						HSD6BGO	203
						HSD6E	203
						HSD7	205
						HSD7E	203
						HSD8	205
						HSD8E	203
						HSD9	205
						HSD916E	203
						HSD9E	203
						HSDAC20	208
						HSDAC27	208
						HSDAC32	208
						HSDFE	205
						HSDK1	212
						HSDK2	212
						HSDK21	212
						HSDK3	212
						HSDK4	212
						HSDK5	212
						HSDK6	212
						HSDK8	212
						HSDQE	205
						HSSC1	207
						HSSC10	207
						HSSC10E	206
						HSSC11	207
						HSSC11E	206
						HSSC12	207
						HSSC12E	206
						HSSC13	207
						HSSC13E	206
						HSSC14	207
						HSSC14E	206
						HSSC15	207
						HSSC15E	206
						HSSC16	207
						HSSC16E	206
						HSSC17	207
						HSSC17E	206
						HSSC18	207
						HSSC18E	206
						HSSC19	207
						HSSC19E	206
						HSSC1E	206
						HSSC2	207
						HSSC20	207
						HSSC20E	206
						HSSC21	207
						HSSC21E	206
						HSSC22	207
						HSSC22E	206
						HSSC23	207
						HSSC23E	206
						HSSC24	207
						HSSC24E	206
						HSSC25	207
						HSSC25E	206
						HSSC26	207
						HSSC26E	206
						HSSC27	207
						HSSC27E	206
						HSSC28	207
						HSSC28E	206
						HSSC29	207
						HSSC29E	206
						HSSC2E	206
						HSSC3	207
						HSSC30	207
						hssc30e	206
						HSSC3E	206
						HSSC4	207
						HSSC40E	206
						HSSC41E	206
						HSSC42E	206
						HSSC43E	206
						HSSC44E	206
						HSSC4E	206
						HSSC5	207
						HSSC5E	206
						HSSC6	207
						HSSC6E	206
						HSSC7	207
						HSSC7E	206
						HSSC8	207
						HSSC8E	206
						HSSC9	207
						HSSC9E	206
						HSSCBLK13	207
						HSSCBLK29	207
						HSSCBLK5	207
						HSSCN10E	208
						HSSCN11E	208
						HSSCN12E	208
						HSSCN17E	208
						HSSCN20E	208
						HSSCN21E	208
						HSSCN22E	208
						HSSCN25E	208
						HSSCN26E	208
						HSSCN27E	208
						HSSCN28E	208
						HSSCN29E	208
						HSSCN30E	208
						HSSCN31E	208
						HSSCN32E	208
						HSSCN35E	208
						HSSCN36E	208
						HSSCN37E	208
						HSSCN40E	208
						HSSCN43E	208
						HSSCN6E	208
						HSSCN7E	208
						HSSCN8E	208
						HSSCN9E	208
						HTB106	119

When Searching Stock # Drop "J"

[www.metallics.us](http://www.metallics.us)



# QUICK REFERENCE PRODUCT INDEX

PART #:	PAGE										
HTB108	119	J1120	153	J1529	136	J2513F	145	JBA1	153	JBBH71	117
HTB11B	118	J1201	142	J1529	136	J2513SS	145	JBA15	153	JBBH72	117
HTB1B	118	J1202	142	J1530	136	J2520F	145	JBA2	153	JBBH73	117
HTB23M	118	J1203	142	J1530	136	J2520R	145	JBA3	153	JBBH74	117
HTB2B	118	J1204	142	J1531	136	J2522	145	JBBH1	116	JBBH75	117
HTB33M	118	J1205	142	J1531	137	J2522SS	145	JBBH11	116	JBBH76	117
HTB3B	118	J1206	142	J1532	136	J2526R	145	JBBH13	116	JBBH77	117
HTB42M	118	J1207	142	J1532	137	J2530F	145	JBBH14	116	JBBH78	117
HTB44M	118	J1208	142	J1533	136	J2552F	145	JBBH15	116	JBBH79	117
HTB45M	118	J1209	142	J1533	137	J3114	145	JBBH16	116	JBBH8	116
HTB46M	118	J1210	142	J1534	136	J3114SS	145	JBBH17	116	JBBH80	117
HTB47M	118	J1211	142	J1534	137	J3124	145	JBBH18	116	JBBH81	116
HTB49B	118	J1212	142	J1535	136	J3124SS	145	JBBH19	116	JBBH82	117
HTB59M	118	J1301	144	J1535	137	J3717	145	JBBH2	116	JBBH83	117
HTB75	119	J1302	144	J1536	136	J3717SS	145	JBBH22	117	JBBH84	117
HTB83	119	J1303	144	J1536	137	J3726F	145	JBBH23	116	JBBH85	117
HTBG343	120	J1304	144	J1537	136	J3730	145	JBBH24	116	JBBH86	117
		J1305	144	J1537	137	J3730SS	145	JBBH25	116	JBBH87	117
		J1306	144	J1538	136	J3732	145	JBBH26	116	JBBH88	116
		J1307	144	J1538	137	J3733F	145	JBBH27	116	JBBH89	117
		J1308	144	J1539	136	J3735F	145	JBBH28	116	JBBH91	116
IPB100	193	J1401	140	J1539	137	J5022	145	JBBH29	116	JBHC1	95
IPB125	193	J1402	140	J1540	137	J5022SS	145	JBBH3	116	JBHC10	95
IPB150	193	J1403	140	J1541	137	J5026	145	JBBH30	116	JBHC101	95
IPB200	193	J1403	140	J1542	137	J5026SS	145	JBBH31	117	JBHC103G	99
IPB250	193	J1405	140	J1543	137	J5030SS	145	JBBH32	116	JBHC103PL	98
IPB300	193	J1406	140	J1544	137	J5040	145	JBBH33	116	JBHC104PL	98
IPB350	193	J1407	140	J1545	137	J5040SS	145	JBBH34	117	JBHC105PL	98
IPB400	193	J1408	140	J1546	137	J5060	145	JBBH35	117	JBHC106PL	98
IPB50	193	J1409	140	J1547	137	J5125	145	JBBH36	117	JBHC107PL	98
IPB500	193	J1501	136	J1548	137	J6222	145	JBBH39	117	JBHC108PL	98
IPB600	193	J1502	136	J1549	137	J6222SS	145	JBBH4	116	JBHC109PL	98
IPB75	193	J1503	136	J1550	137	J6230SS	145	JBBH40	117	JBHC11	95
ISK4	200	J1504	136	J1551	137	J6242	145	JBBH41	117	JBHC110PL	98
IT1000	130	J1505	136	J1551XXV	137	J6242L	145	JBBH42	116	JBHC11PL	97
IT1000	212	J1506	136	J1552	137	J6242SS	145	JBBH43	116	JBHC12	95
ITSLEVE	130	J1507	136	J1552	137	J6256	145	JBBH44	116	JBHC13	95
ITSLEVE	212	J1507SS	136	J1553	137	J6256	145	JBBH45	116	JBHC13G	99
		J1508	136	J1554	137	J6721	140	JBBH46	116	JBHC13PL	98
		J1509	136	J1560	137	J6726	140	JBBH47	116	JBHC14	95
		J1511	136	J1561	137	J7524	145	JBBH47D	116	JBHC14G	99
		J1511SS	136	J1562	137	J7524SS	145	JBBH48	116	JBHC14PL	98
J1001	139	J1511XXV	136	J1563	137	J7542	145	JBBH5	116	JBHC15	95
J1002	139	J1512	136	J1564	137	J7542L	145	JBBH51	116	JBHC15PL	98
J1003	139	J1512SS	136	J1565	137	J7542SS	145	JBBH54	116	JBHC16	95
J1004	139	J1513	136	J1566	137	J7554SS	145	JBBH55	116	JBHC16PL	98
J1005	139	J1514	136	J1567	137	J7562	145	JBBH56	116	JBHC17	95
J1006	139	J1515	136	J1590	137	JALS14	175	JBBH57	116	JBHC17PL	98
J1007	139	J1516	136	J1591	137	JALS15	175	JBBH59	116	JBHC1G	99
J1101	153	J1517	136	J1592	137	JATEK1	175	JBBH59D	116	JBHC1PL	97
J1105	153	J1518	136	J1592SS	137	JATEK150PP	176	JBBH6	116	JBHC2	95
J1106	153	J1519	136	J1593	137	JATEK150SP	176	JBBH60	116	JBHC20	95
J1107	153	J1520	136	J1593SS	137	JATEK225SDC	176	JBBH61	116	JBHC21	96
J1108	153	J1520SS	136	J1594	137	JATEK750SD	176	JBBH62	116	JBHC21PL	98
J1109	153	J1521	136	J1595	137	JATEKELDX	176	JBBH64	116	JBHC22	95
J1110	153	J1522	136	J1595SS	137	JATEKW300	176	JBBH65	116	JBHC23	95
J1111	153	J1523	136	J1596	137	JATEKW300CSS	176	JBBH66	117	JBHC23G	99
J1112	153	J1524	136	J1597	136	JATEKW300ZP	176	JBBH69	117	JBHC23PL	97
J1114	153	J1525	136	J2505	145	JATEKW400ZP	176	JBBH7	116	JBHC24	96
J1115	153	J1528	136	J2512R	145	JATEKW500ZP	176	JBBH70	117	JBHC24G	99
J1116	153	J1528	136	J2513	145	JATEKW600ZP	176				
J1119	153	J1528	136								

When Searching Stock # Drop "J"

[www.metallics.us](http://www.metallics.us)

# QUICK REFERENCE PRODUCT INDEX



PART #:	PAGE										
JBHC24PL	97	JBHC49	95	JBHC76	97	JBL20G	123	JBL546	122	JBRHC48	93
JBHC25	96	JBHC49G	99	JBHC76PL	98	JBL20SS	123	JBL546G	123	JBRHC49	93
JBHC25G	99	JBHC49PL	97	JBHC78G	99	JBL21	122	JBL547	122	JBRHC5	93
JBHC25PL	97	JBHC4G	99	JBHC78PL	98	JBL21G	123	JBL548	122	JBRHC50	93
JBHC26	96	JBHC4PL	97	JBHC7G	99	JBL21SS	123	JBL549	122	JBRHC51	93
JBHC26G	99	JBHC5	95	JBHC7PL	97	JBL22	122	JBL54G	123	JBRHC52	93
JBHC26PL	97	JBHC50	95	JBHC8	95	JBL22G	123	JBL54SS	122	JBRHC54	93
JBHC27	96	JBHC50PL	97	JBHC83	97	JBL23	122	JBL55	121	JBRHC57	93
JBHC27G	99	JBHC51	95	JBHC86	96	JBL23G	123	JBL550	122	JBRHC59	93
JBHC27PL	97	JBHC51G	99	JBHC86PL	98	JBL23SS	123	JBL551	122	JBRHC6	93
JBHC28	96	JBHC51PL	97	JBHC88	95	JBL24	122	JBL552	122	JBRHC60	93
JBHC28G	99	JBHC52	95	JBHC88PL	97	JBL24G	123	JBL553	122	JBRHC61	93
JBHC28PL	97	JBHC52PL	97	JBHC89	96	JBL24SS	123	JBL5583SS	123	JBRHC62	93
JBHC29	96	JBHC53	95	JBHC8G	99	JBL25	122	JBL5586G	124	JBRHC64	93
JBHC2G	99	JBHC54	95	JBHC8PL	97	JBL25G	123	JBL558G	124	JBRHC65	93
JBHC2PL	97	JBHC54PL	98	JBHC9	95	JBL25SS	123	JBL56	121	JBRHC66	93
JBHC3	95	JBHC55	96	JBHC92	95	JBL26	122	JBL56G	123	JBRHC67	93
JBHC30	96	JBHC55PL	98	JBHC93	96	JBL27	122	JBL58	122	JBRHC86	93
JBHC30G	99	JBHC56	97	JBHC93PL	98	JBL27G	123	JBL588	122	JBRHC88	93
JBHC31	96	JBHC561	95	JBHC94	96	JBL27SS	123	JBL58G	123	JBSC1012	21
JBHC31PL	98	JBHC561PL	98	JBHC94PL	98	JBL28	122	JBL590G	124	JBSC10321	21
JBHC32	96	JBHC56PL	98	JBHC95	96	JBL28G	123	JBLW12	88	JBSC1032112	21
JBHC33	96	JBHC57	95	JBHC95PL	98	JBL29	122	JBLW12D	87	JBSC103212	21
JBHC33G	99	JBHC57PL	98	JBHC96	96	JBL29G	123	JBLW14	88	JBSC10322	21
JBHC33PL	98	JBHC58	95	JBHC96PL	98	JBL2S	122	JBLW178	88	JBSC103234	21
JBHC34	96	JBHC59	95	JBHC97	96	JBL3	121	JBLW34	88	JBSC1034	21
JBHC34G	99	JBHC59G	99	JBHC97PL	98	JBL30	122	JBLW38	88	JBSC1038	21
JBHC34PL	98	JBHC59PL	97	JBHC98	96	JBL30G	123	JBLW38D	87	JBSC141	21
JBHC35	96	JBHC5G	99	JBHC98PL	98	JBL30SS	123	JBLW516	88	JBSC14112	21
JBHC35G	99	JBHC5PL	97	JBHC99	96	JBL31	122	JBLW58	88	JBSC1412	21
JBHC35PL	98	JBHC6	95	JBHC99PL	98	JBL32	122	JBLW6	88	JBSC1434	21
JBHC36	96	JBHC60	95	JBL51	121	JBL32G	123	JBLW78	88	JBSC1438	21
JBHC36G	99	JBHC60PL	97	JBL510	122	JBL32SS	123	JBLW8	88	JBSC1458	21
JBHC36PL	98	JBHC61	96	JBL510G	123	JBL33	122	JBRHC1	93	JBSC5	21
JBHC37	96	JBHC61G	99	JBL511	122	JBL33G	124	JBRHC101	93	JBSC5161	21
JBHC37G	99	JBHC61PL	97	JBL511G	123	JBL34	122	JBRHC103	93	JBSC51612	21
JBHC37PL	98	JBHC62	96	JBL511SS50	123	JBL344G	123	JBRHC104	93	JBSC51634	21
JBHC3G	99	JBHC62PL	97	JBL512	122	JBL344G	124	JBRHC105	93	JBSC51638	21
JBHC3PL	97	JBHC63	96	JBL512G	123	JBL346G	124	JBRHC11	93	JBSC51658	21
JBHC4	95	JBHC64	96	JBL512SS	123	JBL34G	124	JBRHC13	93	JBSC51678	21
JBHC40	95	JBHC64G	99	JBL512SS50	123	JBL35G	123	JBRHC14	93	JBSC61	21
JBHC40PL	97	JBHC65	96	JBL513	122	JBL36	122	JBRHC15	93	JBSC612	21
JBHC42	95	JBHC65PL	98	JBL513G	123	JBL36G	123	JBRHC16	93	JBSC614	21
JBHC42G	99	JBHC66	96	JBL513SS	123	JBL36SS	123	JBRHC2	93	JBSC634	21
JBHC42PL	97	JBHC66G	99	JBL514	122	JBL37	121	JBRHC23	93	JBSC638	21
JBHC43	95	JBHC66PL	98	JBL514G	123	JBL37G	123	JBRHC24	93	JBSC81	21
JBHC43PL	97	JBHC67	96	JBL514SS	123	JBL37SS	122	JBRHC25	93	JBSC8112	21
JBHC44	95	JBHC69	96	JBL514SS50	123	JBL38	121	JBRHC26	93	JBSC812	21
JBHC44G	99	JBHC69PL	98	JBL515	122	JBL39	121	JBRHC3	93	JBSC814	21
JBHC44PL	97	JBHC6G	99	JBL515SS	123	JBL39	123	JBRHC33	93	JBSC82	21
JBHC45	95	JBHC6PL	97	JBL516	122	JBL3G	123	JBRHC34	93	JBSC834	21
JBHC45G	99	JBHC7	95	JBL516G	123	JBL34	121	JBRHC35	93	JBSC838	21
JBHC45PL	97	JBHC70	97	JBL516SS	123	JBL41	122	JBRHC4	93	JBWG14	92
JBHC46	96	JBHC71	96	JBL517	122	JBL41G	123	JBRHC40	93	JBWG38	92
JBHC46G	99	JBHC71PL	98	JBL518	122	JBL42	122	JBRHC42	93	JBWSS12	84
JBHC46PL	98	JBHC72	96	JBL518G	123	JBL43	122	JBRHC43	93	JBWSS12HD	84
JBHC47	96	JBHC72PL	98	JBL51G	123	JBL44	122	JBRHC44	93	JBWSS14	84
JBHC47G	99	JBHC74PL	98	JBL51SS	122	JBL44SS	123	JBRHC45	93	JBWSS34	84
JBHC47PL	98	JBHC75	97	JBL52	121	JBL45	122	JBRHC46	93	JBWSS38	84
JBHC48	95	JBHC75PL	98	JBL520	122	JBL45G	123	JBRHC47	93	JC10	173

When Searching Stock # Drop "J"

[www.metallics.us](http://www.metallics.us)

# QUICK REFERENCE PRODUCT INDEX

PART #:	PAGE										
JC10CB.....	173	JCB41SS .....	121	JDIA141SS.....	142	JDS165V.....	32	JDS80 .....	33	JDWSR6C.....	51
JC10CBSS.....	173	JCB42.....	120	JDIA14D .....	142	JDS166.....	33	JDS80SS .....	35	JDWSR7C .....	51
JC10F.....	173	JCB42SS.....	120	JDIA14L.....	142	JDS166V.....	33	JDS80V.....	33	JDWSR9C.....	51
JC10SS.....	173	JCB43.....	120	JDIA14MINI.....	142	JDS168.....	33	JDS81 .....	33	JEB1.....	171
JC10T.....	173	JCB55.....	120	JDIA145S.....	142	JDS168V.....	33	JDS81SS .....	35	JEB100 .....	171
JC12.....	173	JCB55SS.....	121	JDIA34 .....	142	JDS169.....	33	JDS81V.....	33	JEB11.....	171
JC12C.....	173	JCB55SS316 .....	121	JDIA38 .....	142	JDS169V.....	33	JDS83.....	34	JEB124.....	171
JC12CB.....	173	JCB56.....	120	JDIA381SS.....	142	JDS170 .....	33	JDS85.....	34	JEB124SS.....	171
JC12CCL.....	173	JCB56SS.....	121	JDIA38D .....	142	JDS170SS.....	35	JDS86 .....	34	JEB13SS.....	171
JC12CSS .....	173	JCB56SS316 .....	121	JDIA38L.....	142	JDS170V.....	34	JDS87.....	33	JEB14.....	171
JC12M .....	173	JCB6.....	120	JDIA38MINI.....	142	JDS171 .....	34	JDS88 .....	33	JEB15.....	171
JC12MSS .....	173	JCB7 .....	120	JDIA38SS.....	142	JDS171SS.....	35	JDSP154.....	36	JEB1SS.....	171
JC12SS.....	173	JCB71.....	120	JDIA58 .....	142	JDS171V.....	34	JDSP157.....	36	JEB2.....	171
JC14.....	173	JCB75S.....	121	JDIA581SS.....	142	JDS172.....	34	JDSP171.....	36	JEB24.....	171
JC14M .....	173	JCB8.....	121	JDIA58SS .....	142	JDS172SS.....	35	JDSP173 .....	36	JEB3 .....	171
JC16.....	173	JCBM1225SS.....	121	JDP1.....	152	JDS172V.....	34	JDSP174 .....	36	JEB32.....	171
JC16SS.....	173	JCG20 .....	183	JDP2.....	152	JDS173.....	34	JDSP179 .....	36	JEB33.....	171
JC18CB.....	173	JCN160.....	77	JDP3.....	152	JDS173SS.....	35	JDSP180.....	36	JEB3SS .....	171
JC18SS.....	173	JCN161 .....	77	JDP4.....	152	JDS173V.....	34	JDSP181.....	36	JEB3XXSS.....	171
JC35SC .....	174	JCN162SS.....	77	JDP5.....	152	JDS174.....	34	JDSP182.....	36	JEB4 .....	171
JC50SC .....	174	JCN163.....	77	JDP6.....	152	JDS174SS.....	35	JDSP183.....	36	JEB5.....	171
JC6 .....	173	JCN163SS.....	77	JDP7.....	152	JDS174V.....	34	JDSP184.....	36	JEB5SS .....	171
JC8 .....	173	JCN164.....	77	JDP8.....	152	JDS175.....	34	JDSP185.....	36	JEB6 .....	171
JCB1.....	120	JCN164SS.....	77	JDPL1.....	152	JDS175V.....	34	JDSP80 .....	36	JEB8 .....	171
JCB101SS.....	121	JCN165.....	77	JDS143.....	34	JDS176.....	34	JDSP81.....	36	JEB9 .....	171
JCB121SS.....	121	JCN165SS.....	77	JDS143V.....	34	JDS176SS.....	35	JDSP86 .....	36	JEC44.....	177
JCB1SS.....	121	JCN167.....	77	JDS150 .....	32	JDS176V.....	34	JDWC101C.....	50	JEC55.....	177
JCB2.....	120	JCN168SS.....	77	JDS150M .....	32	JDS177.....	34	JDWC11C .....	50	JECN163 .....	177
JCB21.....	120	JCPD1.....	55	JDS150V.....	32	JDS177SS.....	35	JDWC13C.....	50	JEZT1 .....	165
JCB21SS.....	121	JCPD2 .....	55	JDS151.....	33	JDS177V.....	34	JDWC1C.....	50	JFM10.....	16
JCB22SS.....	121	JCPD3 .....	55	JDS151V.....	33	JDS178 .....	34	JDWC3C.....	50	JFM100.....	17
JCB23.....	120	JCPD4 .....	55	JDS152 .....	33	JDS178SS .....	35	JDWC3V.....	50	JFM100SS.....	18
JCB23SS.....	121	JCPD5 .....	55	JDS152M.....	33	JDS178V.....	34	JDWC4C.....	50	JFM101 .....	17
JCB24.....	120	JCPT1.....	139	JDS152SS .....	34	JDS179 .....	34	JDWC5C .....	50	JFM101SS.....	18
JCB24G .....	121	JCPT2 .....	139	JDS152V.....	33	JDS179SS.....	35	JDWC6C.....	50	JFM102.....	17
JCB24SS.....	121	JCPT3 .....	139	JDS153.....	33	JDS180 .....	33	JDWC7C.....	50	JFM102SS.....	18
JCB25.....	120	JCST100 .....	198	JDS153M.....	33	JDS180SS .....	34	JDWC9C.....	50	JFM103.....	17
JCB26.....	120	JCST100I.....	198	JDS153SS.....	34	JDS180V.....	33	JDWS10C.....	51	JFM103SS.....	18
JCB26SS.....	121	JCST100SS.....	197	JDS153V.....	33	JDS181.....	33	JDWS1C .....	51	JFM104.....	17
JCB27.....	120	JCST40.....	198	JDS154SS .....	34	JDS181SS.....	34	JDWS2MD .....	50	JFM104SS.....	18
JCB27G.....	121	JCST40I.....	198	JDS155 .....	33	JDS181V.....	33	JDWS2MD .....	50	JFM105.....	17
JCB28.....	120	JCST40SS.....	197	JDS155V.....	33	JDS182 .....	33	JDWS3C .....	51	JFM106.....	16
JCB28G .....	121	JCW10 .....	84	JDS156 .....	33	JDS182M.....	33	JDWS3CD .....	50	JFM106SS.....	18
JCB28SS.....	121	JCW11 .....	84	JDS156V.....	33	JDS182SS .....	34	JDWS3CD .....	50	JFM107.....	17
JCB29.....	120	JCW12 .....	84	JDS157SS.....	34	JDS182V.....	33	JDWS4C .....	51	JFM107SS.....	18
JCB2SS.....	121	JCW12SS .....	84	JDS158 .....	33	JDS183 .....	33	JDWS4CD .....	50	JFM108.....	17
JCB3.....	120	JCW14 .....	84	JDS158SS .....	34	JDS183SS .....	34	JDWS4CD .....	50	JFM109.....	17
JCB30.....	120	JCW14SS.....	84	JDS158V.....	33	JDS183V.....	33	JDWS4V .....	51	JFM11.....	16
JCB30G .....	121	JDEA12.....	144	JDS159SS .....	34	JDS184 .....	33	JDWS5C.....	51	JFM110.....	17
JCB31.....	120	JDEA14.....	144	JDS160 .....	32	JDS184SS.....	35	JDWS5CD .....	50	JFM110SS.....	18
JCB32.....	120	JDEA38.....	144	JDS160V.....	32	JDS184V.....	33	JDWS5CD .....	50	JFM112.....	18
JCB33.....	120	JDEA516.....	144	JDS161.....	32	JDS185 .....	33	JDWS6C .....	51	JFM113.....	17
JCB33G.....	121	JDEA58.....	144	JDS161M.....	32	JDS185SS.....	35	JDWS75C.....	51	JFM114 .....	18
JCB34.....	120	JDIA12.....	142	JDS161V.....	32	JDS185V.....	33	JDWS7C.....	51	JFM115.....	17
JCB35.....	120	JDIA121SS.....	142	JDS162SS.....	34	JDS186 .....	33	JDWS9C .....	51	JFM116 .....	18
JCB36.....	120	JDIA12D.....	142	JDS163 .....	32	JDS186SS.....	35	JDWSR1C.....	51	JFM117.....	16
JCB37G.....	121	JDIA12L.....	142	JDS163V.....	32	JDS187 .....	34	JDWSR2C.....	51	JFM122.....	17
JCB3SS.....	121	JDIA12MINI.....	142	JDS164.....	32	JDS191.....	34	JDWSR3C.....	51	JFM123.....	18
JCB4.....	120	JDIA12SS.....	142	JDS164V.....	32	JDS192SS.....	34	JDWSR4C.....	51	JFM127.....	17
JCB40.....	120	JDIA14.....	142	JDS165.....	32	JDS5161.....	34	JDWSR5C.....	51	JFM128.....	17

When Searching Stock # Drop "J"

[www.metallics.us](http://www.metallics.us)

# QUICK REFERENCE PRODUCT INDEX



PART #:	PAGE										
JFM129.....	17	JFM69.....	17	JFMP19SS.....	20	JFMP94SS.....	20	JFWP23SS.....	48	JFWPB14.....	49
JFM130.....	18	JFM7.....	17	JFMP22.....	19	JFMP96.....	19	JFWP24.....	47	JFWPB15.....	49
JFM131.....	17	JFM71.....	17	JFMP30.....	19	JFMP98.....	19	JFWP24SS.....	48	JFWPB16.....	49
JFM132.....	17	JFM72.....	18	JFMP31.....	19	JFMP99SS.....	20	JFWP25.....	47	JFWPB17.....	49
JFM133.....	17	JFM73.....	16	JFMP4.....	19	JFW120.....	46	JFWP27.....	47	JFWPB18.....	49
JFM134.....	17	JFM74.....	16	JFMP47.....	19	JFW121.....	46	JFWP28.....	47	JFWPB19.....	49
JFM135.....	18	JFM76.....	17	JFMP48.....	19	JFW122.....	46	JFWP28SS.....	48	JFWPB20.....	49
JFM14.....	17	JFM77.....	17	JFMP48SS.....	20	JFW123.....	46	JFWP29.....	47	JFWPB21.....	49
JFM140.....	16	JFM78.....	18	JFMP49.....	19	JFW125.....	46	JFWP29SS.....	48	JFWPB22.....	49
JFM142.....	16	JFM79.....	16	JFMP49SS.....	20	JFW126.....	46	JFWP30.....	48	JFWPB23.....	49
JFM142SS.....	18	JFM80.....	16	JFMP50SS.....	20	JFW126.....	47	JFWP30SS.....	48	JFWPB24.....	49
JFM142W.....	16	JFM81.....	16	JFMP51SS.....	20	JFW127.....	46	JFWP31.....	48	JFWPB27.....	49
JFM144.....	16	JFM82.....	16	JFMP63.....	19	JFW128.....	47	JFWP31SS.....	48	JFWPB28.....	49
JFM15.....	16	JFM82SS.....	18	JFMP63SS.....	19	JFW129.....	47	JFWP32.....	48	JFWPB29.....	49
JFM150.....	17	JFM83.....	16	JFMP64.....	19	JFW129.....	47	JFWP32SS.....	48	JFWPB30.....	49
JFM152.....	17	JFM83SS.....	18	JFMP64SS.....	19	JFW130.....	47	JFWP33.....	48	JFWPB31.....	49
JFM154.....	17	JFM84.....	16	JFMP65SS.....	20	JFW131.....	47	JFWP33SS.....	48	JFWPB32.....	49
JFM17.....	16	JFM84SS.....	18	JFMP66SS.....	20	JFW132.....	47	JFWP34.....	48	JFWPB33.....	49
JFM17SS.....	18	JFM85.....	16	JFMP67SS.....	20	JFW133.....	47	JFWP34SS.....	48	JFWPB34.....	49
JFM18.....	16	JFM85SS.....	18	JFMP68.....	19	JFW134.....	47	JFWP35.....	48	JFWPB38.....	49
JFM19.....	16	JFM86.....	16	JFMP68SS.....	19	JFW136.....	47	JFWP35SS.....	48	JFWPB39.....	49
JFM190SS.....	18	JFM86SS.....	18	JFMP69.....	19	JFW138.....	47	JFWP36.....	48	JFWPB40.....	49
JFM193SS.....	18	JFM87.....	16	JFMP69SS.....	20	JFW139.....	47	JFWP39.....	48	JFWPB41.....	49
JFM194.....	17	JFM87SS.....	18	JFMP70.....	19	JFW140.....	47	JFWP39SS.....	48	JFWPB42.....	49
JFM194SS.....	18	JFM88.....	16	JFMP70SS.....	20	JFW19.....	46	JFWP40.....	48	JFWPB43.....	49
JFM195.....	17	JFM89.....	16	JFMP71SS.....	20	JFW20.....	46	JFWP40SS.....	48	JFWPB44.....	49
JFM196.....	17	JFM9.....	17	JFMP72.....	19	JFW49.....	47	JFWP41.....	48	JFWPB45.....	49
JFM20.....	17	JFM90.....	16	JFMP72SS.....	20	JFW56.....	47	JFWP41SS.....	48	JFWPB51.....	49
JFM200SS.....	18	JFM91.....	16	JFMP75.....	19	JFW80.....	47	JFWP42.....	48	JFWPB52.....	49
JFM22.....	17	JFM92.....	17	JFMP80.....	19	JFW85.....	47	JFWP42SS.....	48	JFWPB61.....	49
JFM3.....	16	JFM92SS.....	18	JFMP80SS.....	19	JFW89.....	47	JFWP43.....	48	JFWPB62.....	49
JFM30.....	16	JFM93.....	17	JFMP81.....	19	JFW92.....	47	JFWP43SS.....	48	JFWPB63.....	49
JFM31.....	16	JFM94.....	17	JFMP81SS.....	19	JFWP08.....	47	JFWP44.....	48	JFWPB64.....	49
JFM32.....	17	JFM95.....	17	JFMP82.....	19	JFWP09.....	47	JFWP44SS.....	48	JFWPB89.....	49
JFM33.....	17	JFM95SS.....	18	JFMP82M.....	19	JFWP10.....	47	JFWP45.....	48	JG5HC1.....	100
JFM33SS.....	18	JFM96.....	17	JFMP82SS.....	19	JFWP10M.....	47	JFWP46.....	48	JG5HC11.....	100
JFM35.....	17	JFM97.....	17	JFMP83.....	19	JFWP10SS.....	48	JFWP47.....	48	JG5HC119.....	101
JFM36.....	17	JFM97SS.....	18	JFMP83SS.....	19	JFWP11.....	47	JFWP48.....	48	JG5HC12.....	101
JFM38.....	16	JFM98.....	17	JFMP84.....	19	JFWP11M.....	47	JFWP49.....	48	JG5HC120.....	101
JFM39.....	16	JFM99.....	17	JFMP84SS.....	20	JFWP11SS.....	48	JFWP50.....	48	JG5HC121.....	101
JFM4.....	16	JFM99SS.....	18	JFMP85.....	19	JFWP12.....	47	JFWP61.....	47	JG5HC122.....	101
JFM40.....	16	JFMP100.....	19	JFMP85SS.....	20	JFWP120.....	47	JFWP62.....	47	JG5HC123.....	101
JFM41.....	17	JFMP100SS.....	20	JFMP86.....	19	JFWP12SS.....	48	JFWP65.....	47	JG5HC124.....	102
JFM42.....	17	JFMP101.....	19	JFMP86SS.....	20	JFWP13.....	47	JFWP65SS.....	48	JG5HC125.....	102
JFM44.....	17	JFMP101SS.....	20	JFMP87.....	19	JFWP13SS.....	48	JFWP67.....	48	JG5HC127.....	101
JFM46.....	16	JFMP102.....	19	JFMP87SS.....	20	JFWP14.....	47	JFWP67SS.....	48	JG5HC13.....	100
JFM47.....	16	JFMP102SS.....	20	JFMP88.....	19	JFWP14SS.....	48	JFWP69.....	47	JG5HC14.....	100
JFM48.....	17	JFMP103.....	19	JFMP88SS.....	20	JFWP15.....	47	JFWP89.....	48	JG5HC15.....	100
JFM48SS.....	18	JFMP103SS.....	20	JFMP89.....	19	JFWP15.....	47	JFWP9.....	47	JG5HC16.....	100
JFM5.....	16	JFMP104SS.....	20	JFMP89SS.....	20	JFWP17.....	47	JFWP9SS.....	48	JG5HC18.....	101
JFM50.....	17	JFMP105.....	19	JFMP90.....	19	JFWP18SS.....	48	JFWPB04.....	49	JG5HC19.....	100
JFM51.....	17	JFMP105SS.....	20	JFMP90SS.....	20	JFWP19.....	47	JFWPB05.....	49	JG5HC1D.....	100
JFM6.....	17	JFMP107SS.....	20	JFMP91.....	19	JFWP19SS.....	48	JFWPB06.....	49	JG5HC2.....	100
JFM61.....	16	JFMP127.....	19	JFMP91.....	19	JFWP20.....	47	JFWPB07.....	49	JG5HC20.....	101
JFM62.....	16	JFMP127SS.....	20	JFMP91SS.....	20	JFWP20SS.....	48	JFWPB08.....	49	JG5HC21.....	100
JFM63.....	16	JFMP140.....	19	JFMP92.....	19	JFWP21.....	47	JFWPB09.....	49	JG5HC22.....	102
JFM63SS.....	18	JFMP140SS.....	20	JFMP92SS.....	20	JFWP21SS.....	48	JFWPB10.....	49	JG5HC23.....	101
JFM65.....	17	JFMP142.....	19	JFMP93.....	19	JFWP22.....	47	JFWPB11.....	49	JG5HC23D.....	100
JFM66.....	18	JFMP142SS.....	20	JFMP93SS.....	20	JFWP22SS.....	48	JFWPB12.....	49	JG5HC24.....	101
JFM68.....	16	JFMP194.....	19	JFMP94.....	19	JFWP23.....	47	JFWPB13.....	49	JG5HC24D.....	100

When Searching Stock # Drop "J"

[www.metallics.us](http://www.metallics.us)

# QUICK REFERENCE PRODUCT INDEX

PART #:	PAGE				
JG5HC25.....	101	JG5HC81.....	101	JG5HTB38.....	103
JG5HC25D.....	100	JG5HC84.....	102	JG5HTB39.....	103
JG5HC26.....	101	JG5HC85.....	102	JG5HTB3D.....	100
JG5HC26D.....	100	JG5HC88.....	101	JG5HTB4.....	102
JG5HC27.....	101	JG5HC88D.....	100	JG5HTB40.....	103
JG5HC28.....	101	JG5HC90.....	100	JG5HTB43.....	103
JG5HC29.....	101	JG5HCF1.....	100	JG5HTB44.....	103
JG5HC2D.....	100	JG5HCF11.....	100	JG5HTB47.....	103
JG5HC3.....	100	JG5HCF12.....	100	JG5HTB49.....	102
JG5HC30.....	101	JG5HCF13.....	101	JG5HTB49D.....	100
JG5HC31.....	101	JG5HCF14.....	101	JG5HTB4D.....	100
JG5HC32.....	101	JG5HCF15.....	101	JG5HTB5.....	102
JG5HC33.....	101	JG5HCF23.....	101	JG5HTB50.....	102
JG5HC33D.....	100	JG5HCF3.....	100	JG5HTB51.....	102
JG5HC34.....	101	JG5HCF4.....	100	JG5HTB52.....	102
JG5HC35.....	101	JG5HCF42.....	101	JG5HTB53.....	102
JG5HC36.....	101	JG5HCF43.....	101	JG5HTB54.....	103
JG5HC37.....	101	JG5HCF44.....	101	JG5HTB55.....	103
JG5HC3D.....	100	JG5HCF45.....	101	JG5HTB59.....	103
JG5HC4.....	100	JG5HCF50.....	101	JG5HTB6.....	102
JG5HC41.....	100	JG5HCF59.....	101	JG5HTB64.....	103
JG5HC42.....	100	JG5HCF86.....	101	JG5HTB65.....	104
JG5HC43.....	100	JG5HCF95.....	101	JG5HTB66.....	104
JG5HC44.....	101	JG5HCF97.....	101	JG5HTB67.....	103
JG5HC44D.....	100	JG5HTB1.....	102	JG5HTB68.....	104
JG5HC45.....	101	JG5HTB10.....	103	JG5HTB69.....	103
JG5HC45D.....	100	JG5HTB101.....	103	JG5HTB7.....	103
JG5HC46.....	101	JG5HTB102.....	103	JG5HTB70.....	104
JG5HC47.....	101	JG5HTB104.....	103	JG5HTB71.....	104
JG5HC47D.....	100	JG5HTB105.....	103	JG5HTB72.....	104
JG5HC47D.....	100	JG5HTB106.....	103	JG5HTB77.....	103
JG5HC49.....	100	JG5HTB107.....	103	JG5HTB79.....	103
JG5HC49D.....	100	JG5HTB108.....	103	JG5HTB8.....	103
JG5HC5.....	100	JG5HTB12.....	103	JG5HTB88.....	103
JG5HC50CAN.....	100	JG5HTB13.....	103	JG5HTB9.....	103
JG5HC54.....	100	JG5HTB14.....	103	JG5HTB90.....	103
JG5HC58.....	101	JG5HTB15.....	103	JG5HTB91.....	103
JG5HC59.....	101	JG5HTB16.....	103	JG5HTB99.....	103
JG5HC59D.....	100	JG5HTB17.....	103	JG5N163.....	71
JG5HC6.....	100	JG5HTB2.....	102	JG5N163D.....	70
JG5HC60.....	101	JG5HTB20.....	103	JG5N164.....	71
JG5HC60G.....	102	JG5HTB22.....	103	JG5N165.....	71
JG5HC61.....	101	JG5HTB221.....	103	JG5N165D.....	70
JG5HC61G.....	102	JG5HTB23.....	103	JG5N166.....	71
JG5HC62.....	102	JG5HTB24.....	103	JG5N166D.....	70
JG5HC62D.....	100	JG5HTB25.....	103	JG5N167.....	71
JG5HC63.....	102	JG5HTB26.....	103	JG5N168.....	71
JG5HC64.....	101	JG5HTB2650.....	103	JG5N170.....	71
JG5HC64D.....	100	JG5HTB27.....	103	JG5WW584.....	83
JG5HC66.....	102	JG5HTB28.....	103	JG5WW585.....	83
JG5HC67.....	101	JG5HTB29.....	103	JG5WW588.....	83
JG5HC68.....	102	JG5HTB2D.....	100	JG5WW80.....	83
JG5HC69.....	102	JG5HTB3.....	102	JG5WW81.....	83
JG5HC7.....	100	JG5HTB30.....	103	JG5WW82.....	83
JG5HC72.....	102	JG5HTB31.....	103	JG5WW83.....	83
JG5HC73.....	102	JG5HTB33.....	103	JG8HC1.....	104
JG5HC75.....	102	JG5HTB34.....	103	JG8HC114.....	104
JG5HC76.....	102	JG5HTB35.....	103	JG8HC12.....	105
JG5HC78.....	102	JG5HTB36.....	103	JG8HC13.....	104
JG5HC8.....	100	JG5HTB37.....	103	JG8HC14.....	104
				JG8HC15.....	104
				JG8HC16.....	104
				JG8HC17.....	104
				JG8HC18.....	104
				JG8HC19.....	105
				JG8HC2.....	104
				JG8HC20.....	104
				JG8HC21.....	105
				JG8HC214.....	105
				JG8HC22.....	105
				JG8HC23.....	105
				JG8HC231.....	105
				JG8HC232.....	105
				JG8HC2334.....	105
				JG8HC24.....	105
				JG8HC241.....	105
				JG8HC25.....	105
				JG8HC251.....	105
				JG8HC26.....	105
				JG8HC261.....	105
				JG8HC262.....	105
				JG8HC27.....	106
				JG8HC28.....	105
				JG8HC281.....	105
				JG8HC29.....	106
				JG8HC3.....	104
				JG8HC30.....	105
				JG8HC31.....	105
				JG8HC32.....	105
				JG8HC33.....	105
				JG8HC331.....	105
				JG8HC34.....	105
				JG8HC341.....	105
				JG8HC35.....	105
				JG8HC351.....	105
				JG8HC36.....	105
				JG8HC361.....	105
				JG8HC37.....	105
				JG8HC371.....	105
				JG8HC38.....	105
				JG8HC39.....	105
				JG8HC4.....	104
				JG8HC40.....	104
				JG8HC413.....	104
				JG8HC414.....	104
				JG8HC415.....	104
				JG8HC416.....	104
				JG8HC417.....	104
				JG8HC418.....	104
				JG8HC42.....	104
				JG8HC43.....	104
				JG8NYN163.....	76
				JG8NYN164.....	76
				JG8NYN165.....	76
				JG8NYN166.....	76
				JG8NYN167.....	76
				JG8NYN168.....	76
				JG8NYN172.....	76
				JG8SW73.....	83
				JG8SW74.....	83
				JG8SW75.....	83
				JG8SW76.....	83
				JG8SW77.....	83
				JG8SW78.....	83
				JG8SW79.....	83
				JG8SW881.....	83
				JG8WW80.....	83
				JG8WW81.....	83
				JG8WW82.....	83
				JG8WW83.....	83
				JG8WW84.....	83
				JG8WW85.....	83
				JG8WW86.....	83
				JG8WW87.....	83
				JGA1.....	153
				JGA2.....	153
				JGA3.....	153
				JGDS0.....	53
				JGDS1.....	53
				JGDS1M.....	53
				JGDS1V.....	53
				JGDS2.....	53
				JGDS2M.....	53
				JGDS2V.....	53
				JGDS3.....	53
				JGDS3M.....	53
				JGDS3V.....	53
				JGDS4.....	53
				JGDS4V.....	53
				JGDS5.....	53
				JGDS5V.....	53
				JGDS6.....	53
				JGDS7.....	53
				JGS20.....	182
				JGSH14.....	182
				JGSH15.....	182
				JGSH19.....	182
				JGSH20.....	182
				JGSH21.....	182
				JGSH22.....	183
				JGSH23.....	182
				JGSH24.....	182
				JHAB10.....	175
				JHAB11.....	175
				JHAB12.....	175
				JHAB13.....	175
				JHAB14.....	175
				JHAB9.....	175
				JHFW114.....	85
				JHFW117.....	85
				JHHMS33.....	94
				JHHMS33SS.....	94
				JHHMS34.....	94
				JHHMS34SS.....	94
				JHHMS35SS.....	94
				JHHMS48.....	94
				JHHMS48SS.....	94
				JHHMS63.....	94
				JHHMS68.....	94
				JHHMS69.....	94
				JHHMS70.....	94

When Searching Stock # Drop "J"

[www.metallics.us](http://www.metallics.us)



# QUICK REFERENCE PRODUCT INDEX



PART #:	PAGE				
JHHMS80.....	94	JHTB59.....	118	JLW172D.....	87
JHHMS81.....	94	JHTB6.....	118	JLW172G.....	88
JHHMS82.....	94	JHTB60.....	118	JLW172M.....	87
JHHMS84.....	94	JHTB61.....	118	JLW173.....	87
JHHMS85.....	94	JHTB62.....	119	JLW173G.....	88
JHHMS86.....	94	JHTB63.....	119	JLW173M.....	87
JHHMS86SS.....	94	JHTB64.....	118	JLW174.....	87
JHHMS87.....	94	JHTB71.....	119	JLW174D.....	87
JHHMS88.....	94	JHTB72.....	119	JLW174G.....	88
JHHMS89.....	94	JHTB73.....	119	JLW175.....	87
JHHMS89M.....	94	JHTB80.....	118	JLW175D.....	87
JHHMS90.....	94	JHTB81.....	118	JLW175G.....	88
JHHMS94.....	94	JHTB82.....	118	JLW175M.....	87
JHHMS96.....	94	JHTB88.....	118	JLW176.....	87
JHHMS98.....	94	JHTB89.....	119	JLW176G.....	88
JHHN1.....	71	JHTB90.....	118	JLW177.....	87
JHHN12.....	71	JHTB91.....	118	JLW177G.....	88
JHHN12SS.....	73	JHTB93.....	118	JLW178.....	87
JHHN13.....	71	JHTB94.....	119	JLW179.....	87
JHHN13SS.....	73	JHTB95.....	118	JLW180.....	87
JHHN14.....	71	JHTBBR33.....	120	JLW181G.....	88
JHHN15.....	71	JHTBG2.....	119	JLWHA172.....	88
JHHN34.....	71	JHTBG3.....	119	JLWHA173.....	88
JHHN34PL.....	71	JHTBG30.....	120	JLWHA174.....	88
JHHN34PL.....	73	JHTBG31.....	120	JLWHA175.....	88
JHHN34SS.....	73	JHTBG33.....	120	JLWHA176.....	88
JHHN38.....	71	JHTBG45.....	120	JLWHA177.....	88
JHHN58.....	71	JHTBG46.....	120	JLWHA178.....	88
JHHN78.....	71	JHTBG47.....	120	JLWHA180.....	88
JHHN78SS.....	73	JHTBG59.....	120	JLWI1.....	89
JHTB1.....	118	JHTBG64.....	120	JLWI12.....	89
JHTB11.....	118	JHTBG69.....	120	JLWI3.....	89
JHTB13.....	118	JHTBG70.....	120	JLWI3SS.....	90
JHTB2.....	118	JHTBG80.....	120	JLWI4.....	89
JHTB23.....	118	JHW12234.....	151	JLWI4SS.....	90
JHTB24.....	118	JHW12312.....	151	JLWI5.....	89
JHTB25.....	118	JHW12434.....	151	JLWI518SS.....	89
JHTB26.....	118	JHW126.....	151	JLWI5SS.....	90
JHTB27.....	118	JHW14134.....	151	JLWI6.....	89
JHTB3.....	118	JHW14238.....	151	JLWI7.....	89
JHTB33.....	118	JHW345.....	151	JLWI8.....	89
JHTB34.....	118	JHW346.....	151	JLWI9.....	89
JHTB35.....	118	JHW34712.....	151	JLWX1.....	89
JHTB36.....	118	JHW38238.....	151	JLWX10.....	89
JHTB38.....	118	JHW38312.....	151	JLWX12.....	89
JHTB39.....	118	JHW38434.....	151	JLWX2.....	89
JHTB4.....	118	JHW5162.....	151	JLWX3.....	89
JHTB42.....	118	JHW516234.....	151	JLWX3SS.....	89
JHTB43.....	118	JHW584.....	151	JLWX4.....	89
JHTB44.....	118	JHW58434.....	151	JLWX4SS.....	89
JHTB45.....	118	JHW586.....	151	JLWX5.....	89
JHTB46.....	118	JIST18B.....	198	JLWX5M.....	89
JHTB47.....	118	JIST18W.....	198	JLWX5SB.....	89
JHTB48.....	119	JLW153.....	87	JLWX5SS.....	89
JHTB49.....	118	JLW167.....	87	JLWX6.....	89
JHTB5.....	118	JLW168.....	87	JLWX6SS.....	89
JHTB51.....	118	JLW169.....	87	JLWX7.....	89
JHTB54.....	118	JLW170.....	87	JLWX7M.....	89
JHTB55.....	118	JLW171.....	87	JLWX7SB.....	89
JHTB56.....	118	JLW172.....	87	JLWX7SS.....	89
				JLWX8.....	89
				JLWX8M.....	89
				JLWX8SB.....	89
				JLWX8SS.....	89
				JLWX9.....	89
				JLWX9SS.....	89
				JMBHC1016.....	114
				JMBHC1020.....	114
				JMBHC1025.....	114
				JMBHC1030.....	114
				JMBHC1035.....	114
				JMBHC1040.....	114
				JMBHC10401.....	114
				JMBHC1045.....	114
				JMBHC1216.....	114
				JMBHC1220.....	114
				JMBHC1225.....	114
				JMBHC1230.....	114
				JMBHC1235.....	114
				JMBHC1240.....	114
				JMBHC1245.....	114
				JMBHC1250.....	114
				JMBHC1260.....	114
				JMBHC1290.....	114
				JMBHC40.....	113
				JMBHC425.....	113
				JMBHC45.....	113
				JMBHC512.....	113
				JMBHC53.....	113
				JMBHC61.....	113
				JMBHC620.....	114
				JMBHC63.....	113
				JMBHC66.....	114
				JMBHC69.....	114
				JMBHC80.....	114
				JMBHC81.....	114
				JMBHC82.....	114
				JMBHC86.....	114
				JMBHC881.....	114
				JMHTB1012.....	112
				JMHTB1016.....	112
				JMHTB1020.....	112
				JMHTB10201.....	113
				JMHTB1025.....	112
				JMHTB10251.....	113
				JMHTB1030.....	112
				JMHTB10301.....	113
				JMHTB1035.....	112
				JMHTB10351.....	113
				JMHTB1040.....	112
				JMHTB10401.....	113
				JMHTB1045.....	112
				JMHTB1050.....	112
				JMHTB10501.....	113
				JMHTB1055.....	112
				JMHTB1060.....	112
				JMHTB10601.....	113
				JMHTB1070.....	112
				JMHTB10701.....	113
				JMHTB1216.....	112
				JMHTB1220.....	112
				JMHTB12201.....	113
				JMHTB1225.....	112
				JMHTB12251.....	113
				JMHTB1230.....	112
				JMHTB12301.....	113
				JMHTB1235.....	112
				JMHTB12351.....	113
				JMHTB1240.....	112
				JMHTB12401.....	113
				JMHTB1245.....	112
				JMHTB1250.....	112
				JMHTB12501.....	113
				JMHTB1255.....	112
				JMHTB1260.....	112
				JMHTB12601.....	113
				JMHTB1270.....	112
				JMHTB12701.....	113
				JMHTB14251.....	113
				JMHTB14301.....	113
				JMHTB14351.....	113
				JMHTB14401.....	113
				JMHTB14501.....	113
				JMHTB14601.....	113
				JMHTB14701.....	113
				JMHTB310.....	111
				JMHTB312.....	111
				JMHTB316.....	111
				JMHTB320.....	111
				JMHTB38.....	111
				JMHTB410.....	111
				JMHTB412.....	111
				JMHTB416.....	111
				JMHTB420.....	111
				JMHTB425.....	111
				JMHTB430.....	111
				JMHTB48.....	111
				JMHTB510.....	111
				JMHTB512.....	111
				JMHTB516.....	111
				JMHTB520.....	111
				JMHTB525.....	111
				JMHTB530.....	111
				JMHTB535.....	111
				JMHTB540.....	111
				JMHTB58.....	111
				JMHTB610.....	111
				JMHTB6101.....	112
				JMHTB612.....	111
				JMHTB6121.....	112
				JMHTB6122SS.....	113
				JMHTB616.....	111
				JMHTB6161.....	112
				JMHTB620.....	111
				JMHTB6201.....	112
				JMHTB625.....	111
				JMHTB6251.....	112
				JMHTB630.....	111
				JMHTB6301.....	112
				JMHTB635.....	112
				JMHTB6351.....	112
				JMHTB640.....	112
				JMHTB6401.....	112
				JMHTB645.....	112
				JMHTB6451.....	112
				JMHTB650.....	112
				JMHTB6501.....	112
				JMHTB6601.....	112
				JMHTB6701.....	112
				JMHTB68.....	111
				JMHTB810.....	112
				JMHTB8101.....	112
				JMHTB812.....	112
				JMHTB8121.....	112
				JMHTB8122SS.....	113
				JMHTB816.....	112
				JMHTB8161.....	112
				JMHTB816SS.....	113
				JMHTB820.....	112
				JMHTB8201.....	113
				JMHTB825.....	112
				JMHTB8251.....	113
				JMHTB830.....	112
				JMHTB8301.....	113
				JMHTB835.....	112
				JMHTB8351.....	113
				JMHTB840.....	112
				JMHTB8401.....	113
				JMHTB845.....	112
				JMHTB850.....	112
				JMHTB8501.....	113
				JMHTB860.....	112
				JMHTB8601.....	113
				JMHTB8651.....	113
				JMHTB8701.....	113
				JMLW010.....	90
				JMLW010.....	90
				JMLW012.....	90
				JMLW012.....	90
				JMLW016.....	90
				JMLW016.....	90
				JMLW02SS.....	90
				JMLW02SS.....	91
				JMLW03.....	90
				JMLW03.....	90
				JMLW03SS.....	90
				JMLW03SS.....	91
				JMLW04.....	90
				JMLW04.....	90
				JMLW04SS.....	90
				JMLW04SS.....	91
				JMLW05.....	90
				JMLW05.....	90
				JMLW06.....	90
				JMLW06.....	90
				JMLW06SS.....	90
				JMLW06SS.....	91
				JMLW08.....	90
				JMLW08.....	90
				JMLW08SS.....	91

When Searching Stock # Drop "J"

[www.metallics.us](http://www.metallics.us)



# QUICK REFERENCE PRODUCT INDEX

PART #:	PAGE										
JMLW10SS	91	JMSBHC105	114	JMSW21	91	JN166D	70	JNYN163SS	76	JPFMMV2231250	178
JMLW10SS316	91	JMSBHC1050	114	JMSW22	91	JN166G	73	JNYN164	75	JPFMWAC2251500	176
JMLW12SS	91	JMSBHC106	114	JMSW22SS	91	JN166J	73	JNYN164SS	76	JPFMWDD2271000	178
JMLW12SS316	91	JMSBHC1220	114	JMSW23	91	JN166PL	71	JNYN164SS316	76	JPFMWH2261000	178
JMLW16SS	91	JMSBHC1225	114	JMSW24	91	JN167	70	JNYN165	75	JPFMWH2261050	178
JMLW6SS316	91	JMSBHC123	114	JMSW25	91	JN167BR	72	JNYN165SS	76	JPFMWH2261100	178
JMLW8SS316	91	JMSBHC1240	115	JMSW26	91	JN167G	73	JNYN165SS316	76	JPFMWH2261150	178
JMLWC006	90	JMSBHC125	115	JMSW5SS	84	JN167J	73	JNYN165SSHH	76	JPFMWP2281100	178
JMLWC006	90	JMSBHC126	115	JMSW6SS	84	JN167PL	71	JNYN166	75	JPFMWV2251000	178
JMLWC010	90	JMSBHC1260316	115	JMSW6SS316	84	JN168	70	JNYN166SS	76	JPFMWV2251050	178
JMLWC010	90	JMSBHC1430	115	JMSW8SS	84	JN168BR	72	JNYN166SSHH	76	JPFMWV2251100	178
JMLWHC008	90	JMSBHC40	114	JMSW8SS316	84	JN168G	73	JNYN167	75	JPFMWV2251150	178
JMLWHC008	90	JMSBHC425	114	JMSWS20	91	JN168J	73	JNYN167SS	76	JPFMWV2251200	178
JMLWHC010	90	JMSBHC45	114	JMSWS23	91	JN168PL	71	JNYN168	75	JPFMWV2251250	178
JMLWHC010	90	JMSBHC525	114	JMSWS24	91	JN170	70	JNYN169	75	JPFMWV2251300	178
JMLWHC012	90	JMSBHC53	114	JMSWS25	91	JN170PL	71	JNYN169SS	76	JPMP100	14
JMLWHC012	90	JMSBHC56	114	JMSWS30	91	JN171BR	72	JNYN170	75	JPMP101	14
JMLWHC014	90	JMSBHC612	114	JMSWS31	91	JN173	70	JNYN170SS	76	JPMP102	14
JMLWHC014	90	JMSBHC616	114	JN150	70	JN173G	73	JNYN171	75	JPMP103	14
JMLWHC020	90	JMSBHC620	114	JN151	70	JN174	70	JNYN171SS	76	JPMP1032	14
JMLWHC020	90	JMSBHC625	114	JN153	70	JN178	70	JNYN172	75	JPMP1032BLK	14
JMLWI3	90	JMSBHC630316	115	JN156	70	JN179	70	JNYN172SS	76	JPMP104	14
JMLWI5	90	JMSBHC69	114	JN156BR	72	JNA140	152	JNYN173	75	JPMP113	13
JMLWI6SS	90	JMSBHC812575	114	JN157	70	JNA141	152	JNYN173SS	76	JPMP114	14
JMPMP258SS	15	JMSBHC820316	115	JN158	70	JNA1414	152	JNYN174	75	JPMP118	13
JMPMP310	15	JMSBHC825	114	JN159	70	JNA1414SS	152	JNYN174SS	76	JPMP119	13
JMPMP36	15	JMSBHC830	114	JN159BR	72	JNA1415	152	JNYN175SS	76	JPMP120	13
JMPMP38	15	JMSBHC834	114	JN159M	70	JNA141SS	152	JNYN177	75	JPMP128	14
JMPMP38SS	15	JMSBHC88	114	JN160	70	JNA142	152	JNYNF167	76	JPMP13	13
JMPMP410	15	JMSHC1230SS	24	JN160BR	72	JNA142SS	152	JPDS1C	54	JPMP20	14
JMPMP412	15	JMSHC1245	24	JN160D	70	JNA143	152	JPDS1V	54	JPMP21	13
JMPMP414	15	JMSHC258	24	JN161	70	JNA316	152	JPDWIC	54	JPMP22	13
JMPMP420	15	JMSHC345SS	24	JN161BR	72	JNF160	70	JPFMCDD2271050	177	JPMP23	13
JMPMP430	15	JMSHC365SS	24	JN161D	70	JNF163	70	JPFMCP2281300	177	JPMP24	13
JMPMP46	15	JMSHC412SS	24	JN162	70	JNF164	70	JPFMCV2211100	177	JPMP33	14
JMPMP465SS	16	JMSHC420SS	24	JN162BR	72	JNF165	70	JPFMCV2211200	177	JPMP36	14
JMPMP46SS	15	JMSHC512SS	24	JN162D	70	JNF171	70	JPFMCV2211250	177	JPMP37	13
JMPMP48	15	JMSHC520SS	24	JN163	70	JNF177	70	JPFMCVE1421000	177	JPMP38	14
JMPMP510	15	JMSHC650	24	JN163BLACK	72	JNM010	74	JPFMCVE1421050	177	JPMP39	13
JMPMP510SS	16	JMSW010	84	JN163BR	72	JNM012	74	JPFMD227110N	178	JPMP4	13
JMPMP512	15	JMSW0101	84	JN163D	70	JNM016	74	JPFMD227120N	178	JPMP40	13
JMPMP516	15	JMSW012	84	JN163G	73	JNM020	74	JPFMD227130N	178	JPMP41	14
JMPMP516SS	16	JMSW0121	84	JN163J	73	JNM024	74	JPFMMAC2231500	176	JPMP42	14
JMPMP520	15	JMSW016	84	JN163M	70	JNM03	74	JPFMMAC2231550	176	JPMP43	13
JMPMP58	15	JMSW020	84	JN163PL	71	JNM04	74	JPFMMH2241100	178	JPMP5	14
JMPMP610	15	JMSW020SS	84	JN164	70	JNM05	74	JPFMMH224110N	178	JPMP6	14
JMPMP612	15	JMSW024	84	JN164BR	72	JNM06	74	JPFMMH2241150	178	JPMP63	13
JMPMP616	15	JMSW03	84	JN164G	73	JNM08	74	JPFMMH224115N	178	JPMP66	13
JMPMP620	15	JMSW04	84	JN164J	73	JNYN159	75	JPFMMH2241200	178	JPMP69	14
JMPMP630	15	JMSW05	84	JN164M	70	JNYN159SS	76	JPFMMH224120N	178	JPMP75	14
JMPMP635	15	JMSW06	84	JN164PL	71	JNYN160	75	JPFMMH2241250	178	JPMP76	14
JMPMP640	15	JMSW061	84	JN165	70	JNYN1601SS	76	JPFMMH2241250	178	JPMP78	13
JMPMP665SS	16	JMSW08	84	JN165BLACK	72	JNYN160SS	76	JPFMMH2241250	178	JPMP80	13
JMPMP812	15	JMSW081	84	JN165BR	72	JNYN161	75	JPFMMV2231000	178	JPMP81	13
JMPMP830SS	16	JMSW10SS	84	JN165D	70	JNYN161SS	76	JPFMMV2231100	178	JPMP82	13
JMPMP860	15	JMSW10SS316	84	JN165G	73	JNYN162	75	JPFMMV223110N	178	JPMP84	13
JMSBHC102	114	JMSW12SS	84	JN165J	73	JNYN162SS	76	JPFMMV2231150	178	JPMP85	13
JMSBHC103	114	JMSW12SS316	84	JN165PL	71	JNYN163	75	JPFMMV223115N	178	JPMP86	13
JMSBHC1040	114	JMSW14SS	84	JN166	70	JNYN1631SS	76	JPFMMV2231200	178	JPMP87	13
JMSBHC1040316	115	JMSW20	91	JN166BLACK	72	JNYN163M	75	JPFMMV223120N	178	JPMP88	13

When Searching Stock # Drop "J"

[www.metallics.us](http://www.metallics.us)

# QUICK REFERENCE PRODUCT INDEX



PART #:	PAGE										
JPMP89	13	JR110	92	JRM127SLT	6	JRM45SLT	6	JRM95SLT	6	JRSH25100N	179
JPMP90	13	JR111	92	JRM128	8	JRM46SLT	5	JRM96	8	JRSH251125	179
JPMP99	14	JR112	92	JRM128SLT	6	JRM47SLT	5	JRM96SLT	6	JRSH37100N	179
JPSA1/jar	164	JR113	92	JRM12SLT	6	JRM48	8	JRM97	8	JRSH37112N5	179
JPSAL2	164	JR114	92	JRM130	8	JRM48M	8	JRM98	8	JRSV25100	180
JQK1	36	JR115	92	JRM130SLT	7	JRM49SLT	7	JRM99	8	JRSV37100N	180
JQK10	36	JR116	92	JRM131SLT	6	JRM4SLT	5	JRM99SLT	6	JRSV37112	180
JQK10V	36	JR117	92	JRM132	8	JRM50SLT	6	JRMB1	11	JRSV37112N	180
JQK12114	37	JR118	92	JRM132SLT	6	JRM51	8	JRMB100	11	JRSV37112N5	180
JQK15	36	JR119	92	JRM133	8	JRM51SLT	7	JRMB102	11	JRSV37200	180
JQK15GR	38	JRA1	153	JRM133SLT	6	JRM52SLT	6	JRMB103	11	JRWH25100	179
JQK15GRV	38	JRA15	153	JRM134	8	JRM53SLT	7	JRMB104	11	JRWH37200	179
JQK15V	36	JRA2	153	JRM134SLT	6	JRM54SLT	7	JRMB105	11	JRWH37212	179
JQK15W	38	JRA3	153	JRM135	8	JRM55SLT	7	JRMB108	11	JRWS10	29
JQK15WV	38	JRCA12SLV25	144	JRM135SLT	7	JRM61SLT	5	JRMB113	11	JRWS10M	29
JQK16	36	JRCA38150	144	JRM136	7	JRM62SLT	5	JRMB140	11	JRWS10V	29
JQK16GR	38	JRDS1	55	JRM136SLT	6	JRM63	7	JRMB15	11	JRWS11	29
JQK16GRV	38	JRDS1M	55	JRM136SLT	8	JRM65	8	JRMB2	11	JRWS11V	29
JQK16V	36	JRDS1V	55	JRM137SLT	6	JRM65SLT	6	JRMB22	11	JRWS12	29
JQK16W	38	JRDS2	55	JRM138SLT	6	JRM66	8	JRMB30	11	JRWS12V	29
JQK16WV	38	JRDS2M	55	JRM139	7	JRM66SLT	7	JRMB48	11	JRWS12W	29
JQK17	37	JRDS2V	55	JRM13SLT	6	JRM67SLT	7	JRMB49	11	JRWS26	29
JQK17GR	38	JRDS3	55	JRM140	7	JRM68	7	JRMB6	11	JRWS26V	29
JQK17GRV	38	JRDS3V	55	JRM141SLT	6	JRM69	8	JRMB61	11	JRWS27	29
JQK17V	37	JRDS4	55	JRM142	7	JRM71	8	JRMB62	11	JRWS27V	29
JQK17W	38	JRDS4V	55	JRM143SLT	7	JRM72	8	JRMB63	11	JRWS28	29
JQK17WV	38	JRDS5	55	JRM144SLT	5	JRM72SLT	7	JRMB64	11	JRWS28V	29
JQK19	37	JRDS6	55	JRM148SLT	5	JRM73SLT	5	JRMB65	11	JRWS29	29
JQK19V	37	JRM100	8	JRM150SLT	6	JRM74SLT	5	JRMB66	11	JRWS29M	29
JQK19W	38	JRM100SLT	6	JRM152SLT	6	JRM75	8	JRMB69	11	JRWS29V	29
JQK19WCCL	38	JRM101	8	JRM154SLT	6	JRM78	8	JRMB7	11	JRWS30	29
JQK1V	36	JRM102	8	JRM155SLT	5	JRM79SLT	7	JRMB73	11	JRWS30V	29
JQK20	37	JRM103	8	JRM16SLT	5	JRM80	7	JRMB75	11	JRWS31	29
JQK20V	37	JRM103SLT	6	JRM17	7	JRM81	7	JRMB76	11	JRWS31V	29
JQK21	37	JRM104	8	JRM18	7	JRM81SLT	5	JRMB77	11	JRWS7	29
JQK21CCL	37	JRM104SLT	6	JRM19	7	JRM82	7	JRMB78	11	JRWS7V	29
JQK21V	37	JRM105	8	JRM190	8	JRM82I	7	JRMB79	11	JRWS8	29
JQK22	37	JRM105SLT	6	JRM20	8	JRM82SLT	5	JRMB8	11	JRWS8V	29
JQK22V	37	JRM106SLT	6	JRM20M	8	JRM82W	7	JRMB80	11	JRWS9	29
JQK23	37	JRM107SLT	5	JRM22	8	JRM83	7	JRMB83	11	JRWS9V	29
JQK23V	37	JRM108SLT	6	JRM23	7	JRM84	7	JRMB85	11	JRWV25200	180
JQK25	37	JRM109	8	JRM23SLT	6	JRM85	7	JRMB86	11	JRWV37100	180
JQK25V	37	JRM109SLT	6	JRM30SLT	5	JRM86	7	JRMB87	11	JRWV37200	180
JQK30	37	JRM10SLT	5	JRM312SLT	6	JRM86M	7	JRMB88	11	JRWV37212	180
JQK30V	37	JRM110	8	JRM31SLT	5	JRM87	7	JRMB90	11	JSBH1	107
JQK5	36	JRM112SLT	6	JRM32	7	JRM87SLT	6	JRMB91	11	JSBH10	107
JQK59	37	JRM113	8	JRM32M	7	JRM88	7	JRMB92	11	JSBH101	107
JQK59V	37	JRM114	8	JRM33	8	JRM89	7	JRMB93	11	JSBH11	107
JQK5V	36	JRM115SLT	6	JRM34SLT	6	JRM89SLT	6	JRMB94	11	JSBH11D	106
JQK60	37	JRM116	8	JRM35SLT	6	JRM89V	7	JRMB95	11	JSBH12	108
JR100	92	JRM116SLT	7	JRM36	8	JRM90	7	JRMB96	11	JSBH126	110
JR101	92	JRM115SLT	5	JRM36SLT	7	JRM90SLT	6	JRMB98	11	JSBH13	108
JR102	92	JRM120	8	JRM37SLT	6	JRM91	7	JRMB99	11	JSBH131	110
JR103	92	JRM121	8	JRM38SLT	6	JRM91SLT	6	JRSDS1	56	JSBH14	108
JR104	92	JRM122SLT	6	JRM39SLT	5	JRM92	7	JRSDS2	56	JSBH142	110
JR105	92	JRM123	8	JRM3SLT	5	JRM93	7	JRSDS3	56	JSBH15	108
JR106	92	JRM123SLT	7	JRM41	7	JRM93SLT	6	JRSDS4	56	JSBH16	108
JR107	92	JRM124SLT	6	JRM41SLT	6	JRM94	7	JRSDS5	56	JSBH17	108
JR108	92	JRM125SLT	6	JRM42SLT	6	JRM94SLT	6	JRSDS6	56	JSBH171	110
JR109	92	JRM127	8	JRM44SLT	6	JRM95	7	JRSDS7	56	JSBH178	107

When Searching Stock # Drop "J"

[www.metallics.us](http://www.metallics.us)

# QUICK REFERENCE PRODUCT INDEX

PART #:	PAGE										
JSBH181.....	110	JSBH31D.....	107	JSBH491.....	110	JSBH93.....	109	JSH1.....	172	JSHC516212.....	22
JSBH182.....	110	JSBH32.....	108	JSBH49D.....	106	JSBH94.....	109	JSH2.....	172	JSHC5163.....	22
JSBH183.....	110	JSBH33.....	109	JSBH4D.....	106	JSBH961.....	111	JSHC101.....	22	JSHC51634.....	22
JSBH184.....	110	JSBH332.....	110	JSBH4L.....	107	JSBH97.....	107	JSHC10112.....	22	JSHC51658.....	22
JSBH19.....	109	JSBH334.....	110	JSBH5.....	107	JSBH990.....	111	JSHC10114.....	22	JSHC51678.....	22
JSBH1D.....	106	JSBH336.....	110	JSBH501.....	108	JSBH991.....	111	JSHC1012.....	22	JSHC581.....	23
JSBH2.....	107	JSBH337.....	110	JSBH502.....	108	JSBH992.....	111	JSHC1012SS.....	24	JSHC58112.....	23
JSBH200.....	107	JSBH339.....	110	JSBH503.....	109	JSBH995.....	111	JSHC10134.....	22	JSHC58114.....	23
JSBH201.....	107	JSBH33D.....	107	JSBH505.....	109	JSBN12.....	72	JSHC101SS.....	24	JSHC58134.....	23
JSBH202.....	107	JSBH34.....	109	JSBH51.....	107	JSBN14.....	72	JSHC102.....	22	JSHC582.....	23
JSBH203.....	107	JSBH341.....	110	JSBH51D.....	106	JSBN24.....	72	JSHC102SS.....	24	JSHC58212.....	23
JSBH204.....	107	JSBH34D.....	107	JSBH54.....	108	JSBN32.....	72	JSHC1034.....	22	JSHC58214.....	23
JSBH205.....	107	JSBH35.....	109	JSBH541.....	110	JSBN34.....	72	JSHC1034SS.....	24	JSHC58234.....	23
JSBH206.....	108	JSBH350.....	109	JSBH55.....	107	JSBN38.....	72	JSHC1038.....	22	JSHC583.....	23
JSBH207.....	108	JSBH351.....	110	JSBH551.....	110	JSBN38D.....	72	JSHC1058.....	22	JSHC58312.....	23
JSBH22.....	108	JSBH353.....	110	JSBH552.....	110	JSBN516.....	72	JSHC1078.....	22	JSHC584.....	23
JSBH23.....	108	JSBH354.....	110	JSBH59.....	108	JSBN58.....	72	JSHC141.....	22	JSHC58412.....	23
JSBH231.....	110	JSBH355.....	109	JSBH599.....	109	JSBN6.....	72	JSHC14112.....	22	JSHC585.....	23
JSBH231D.....	107	JSBH356.....	110	JSBH59D.....	107	JSBN8.....	72	JSHC14114.....	22	JSHC61.....	22
JSBH232.....	108	JSBH3581.....	109	JSBH5D.....	106	JSBW10.....	81	JSHC1412.....	22	JSHC612.....	22
JSBH234.....	110	JSBH3582.....	109	JSBH600.....	109	JSBW12.....	81	JSHC1412SS.....	24	JSHC612SS.....	23
JSBH234D.....	107	JSBH35D.....	107	JSBH601.....	109	JSBW14.....	81	JSHC14134.....	22	JSHC612SS.....	23
JSBH236.....	110	JSBH36.....	107	JSBH602.....	109	JSBW38.....	81	JSHC141SS.....	24	JSHC614.....	22
JSBH236D.....	107	JSBH36D.....	106	JSBH603.....	109	JSBW516.....	81	JSHC142.....	22	JSHC614SS.....	23
JSBH2371.....	110	JSBH37.....	109	JSBH604.....	109	JSBW58.....	81	JSHC1434.....	22	JSHC614SS.....	23
JSBH238.....	110	JSBH38.....	109	JSBH605.....	109	JSBW6.....	81	JSHC1434SS.....	24	JSHC61SS.....	23
JSBH23D.....	107	JSBH39.....	109	JSBH611.....	110	JSBW8.....	81	JSHC1438.....	22	JSHC61SS.....	23
JSBH24.....	108	JSBH39D.....	107	JSBH64.....	109	JSDS1C.....	52	JSHC14414.....	22	JSHC634.....	22
JSBH241.....	108	JSBH3D.....	106	JSBH64D.....	107	JSDS3C.....	52	JSHC1458.....	22	JSHC634SS.....	23
JSBH24D.....	107	JSBH3L.....	107	JSBH65.....	109	JSDS4C.....	52	JSHC1458SS.....	24	JSHC634SS.....	23
JSBH25.....	108	JSBH4.....	107	JSBH651.....	110	JSDS5C.....	52	JSHC1478.....	22	JSHC638.....	22
JSBH250.....	108	JSBH40.....	109	JSBH65D.....	107	JSDS6C.....	52	JSHC3212SS.....	24	JSHC658.....	22
JSBH251.....	110	JSBH400.....	108	JSBH670.....	111	JSDS7C.....	52	JSHC321SS.....	24	JSHC7121.....	23
JSBH252.....	110	JSBH401.....	108	JSBH671.....	111	JSDS9C.....	52	JSHC3234SS.....	24	JSHC712112.....	23
JSBH252D.....	107	JSBH402.....	108	JSBH7.....	107	JSE1.....	171	JSHC325SS.....	24	JSHC712114.....	23
JSBH253.....	110	JSBH403.....	108	JSBH700.....	109	JSE13.....	171	JSHC34112.....	23	JSHC712134.....	23
JSBH254.....	110	JSBH404.....	108	JSBH701.....	109	JSE2.....	171	JSHC34114.....	23	JSHC7122.....	23
JSBH255.....	110	JSBH405.....	108	JSBH702.....	109	JSE3.....	171	JSHC34134.....	23	JSHC712212.....	23
JSBH2561.....	110	JSBH406.....	108	JSBH703.....	109	JSE4.....	171	JSHC342.....	23	JSHC712234.....	23
JSBH25D.....	107	JSBH41.....	107	JSBH704.....	109	JSE5.....	171	JSHC34212.....	23	JSHC7123.....	23
JSBH26.....	108	JSBH411.....	110	JSBH71.....	108	JSE7.....	171	JSHC34214.....	23	JSHC712312.....	23
JSBH261.....	108	JSBH412.....	107	JSBH73.....	108	JSEA12.....	143	JSHC343.....	23	JSHC71234.....	23
JSBH26D.....	107	JSBH412D.....	106	JSBH74.....	109	JSEA14.....	143	JSHC34312.....	23	JSHC7124.....	23
JSBH27.....	108	JSBH413.....	107	JSBH771.....	110	JSEA38.....	143	JSHC344.....	23	JSHC7161.....	22
JSBH27D.....	107	JSBH413D.....	106	JSBH78D.....	106	JSEA516.....	143	JSHC345.....	23	JSHC716112.....	23
JSBH28.....	108	JSBH41D.....	106	JSBH799.....	109	JSEA58.....	143	JSHC381.....	22	JSHC716114.....	22
JSBH281.....	108	JSBH42.....	108	JSBH800.....	109	JSFN1024.....	76	JSHC38112.....	22	JSHC71612.....	22
JSBH28D.....	107	JSBH421.....	110	JSBH801.....	109	JSFN1024SS.....	76	JSHC38114.....	22	JSHC716134.....	23
JSBH29.....	108	JSBH43.....	108	JSBH808.....	109	JSFN1032.....	76	JSHC3812.....	22	JSHC7162.....	23
JSBH291.....	108	JSBH435.....	110	JSBH81.....	109	JSFN1032SS.....	76	JSHC38134.....	22	JSHC71634.....	22
JSBH2D.....	106	JSBH44.....	108	JSBH811.....	110	JSFN1213.....	76	JSHC382.....	22	JSHC81.....	22
JSBH3.....	107	JSBH44D.....	107	JSBH81D.....	107	JSFN1213SS.....	77	JSHC3834.....	22	JSHC812.....	22
JSBH30.....	108	JSBH45.....	108	JSBH82.....	108	JSFN1420.....	76	JSHC3858.....	22	JSHC812SS.....	23
JSBH300.....	108	JSBH45D.....	107	JSBH86.....	108	JSFN1420SS.....	77	JSHC3878.....	22	JSHC812SS.....	24
JSBH301.....	108	JSBH46.....	109	JSBH88.....	108	JSFN3816.....	76	JSHC5161.....	22	JSHC814.....	22
JSBH302.....	108	JSBH46D.....	107	JSBH9.....	107	JSFN3816SS.....	77	JSHC516112.....	22	JSHC81SS.....	23
JSBH303.....	108	JSBH47.....	109	JSBH912.....	109	JSFN51618.....	76	JSHC516114.....	22	JSHC81SS.....	24
JSBH304.....	108	JSBH47D.....	107	JSBH913.....	109	JSFN51618SS.....	77	JSHC51612.....	22	JSHC834.....	22
JSBH305.....	108	JSBH48.....	108	JSBH914.....	109	JSFN832.....	76	JSHC516134.....	22	JSHC834SS.....	23
JSBH31.....	108	JSBH49.....	107	JSBH919.....	109	JSFN832SS.....	76	JSHC5162.....	22	JSHC834SS.....	24

When Searching Stock # Drop "J"

[www.metallics.us](http://www.metallics.us)

PART #:	PAGE										
JSHC838	22	JSHTB63D	117	JSN14316SS	73	JSPM8SS	13	JSRM12	9	JSRM32	9
JSHC838SS	23	JSHTB64D	117	JSN1431SSD	72	JSPM9SS	13	JSRM13	9	JSRM32P	10
JSHC838SS	24	JSHTB65D	117	JSN14D	71	JSPMP100SS	15	JSRM130	9	JSRM33	9
JSHC858	22	JSHTB661	119	JSN14L	72	JSPMP102SS	15	JSRM131	9	JSRM33P	10
JSHC858SS	23	JSHTB661D	117	JSN15	72	JSPMP116SS	15	JSRM132	9	JSRM34	9
JSHC858SS	24	JSHTB662	119	JSN15316SS	73	JSPMP122434SS	15	JSRM132P	10	JSRM35	9
JSHC878	22	JSHTB663	119	JSN16	72	JSPMP132SS	15	JSRM133	9	JSRM36P	10
JSHK0	172	JSHTB772	119	JSN16316SS	73	JSPMP141SS	14	JSRM134	9	JSRM40	10
JSHK0ASS	172	JSHTB773	119	JSN16D	71	JSPMP144SS	14	JSRM135	9	JSRM41	10
JSHK1	172	JSLW1	88	JSN16TW	71	JSPMP155SS	14	JSRM137P	10	JSRM42	10
JSHK1A	172	JSLW10	88	JSN17	72	JSPMP165SS	14	JSRM138P	10	JSRM43	10
JSHK1SS	172	JSLW101	88	JSN18	72	JSPMP175SS	14	JSRM139P	10	JSRM44	10
JSHK2	172	JSLW10D	87	JSN182	72	JSPMP185SS	14	JSRM13P	10	JSRM45	10
JSHK2A	172	JSLW10L	88	JSN18D	71	JSPMP185SS316	15	JSRM14	9	JSRM50	9
JSHK2ASS	172	JSLW11	88	JSN18D	71	JSPMP1SS	14	JSRM140P	10	JSRM51	9
JSHK2SS	172	JSLW111	88	JSN19	72	JSPMP205SS	14	JSRM141	9	JSRM60	9
JSHK3	172	JSLW12	87	JSN19316SS	73	JSPMP215SS	14	JSRM144	9	JSRM61	9
JSHK3SS	172	JSLW3	87	JSN20	72	JSPMP215SS316	15	JSRM146	9	JSRM66	9
JSHK4	172	JSLW34	88	JSN20316SS	73	JSPMP225SS	14	JSRM146	10	JSRM71	9
JSHK5	172	JSLW341	88	JSN21	72	JSPMP235SS	15	JSRM1461	10	JSRM721	10
JSHK6	172	JSLW34L	88	JSN21L	72	JSPMP295SS	15	JSRM147	9	JSRM722	9
JSHTB1	119	JSLW4	87	JSN22	72	JSPMP2SS	14	JSRM148	9	JSRM74	9
JSHTB11	119	JSLW41	88	JSN22316SS	73	JSPMP305SS	14	JSRM148P	10	JSRM74P	10
JSHTB2	119	JSLW5	87	JSN23	72	JSPMP335SS	14	JSRM14P	10	JSRM80	9
JSHTB23	119	JSLW6	87	JSN24	73	JSPMP335SSV	14	JSRM15	9	JSRM82P	10
JSHTB24	119	JSLW6V	87	JSN24316SS	73	JSPMP355SS	15	JSRM154	9	JSRM85	9
JSHTB25	119	JSLW7	87	JSN25316SS	73	JSPMP365SS	15	JSRM15P	10	JSRM85P	10
JSHTB26	119	JSLW71	88	JSN26	72	JSPMP375SS	15	JSRM16	9	JSRM86	9
JSHTB3	119	JSLW78	88	JSN34	73	JSPMP385SS	15	JSRM16P	10	JSRM90	9
JSHTB30	119	JSLW781	88	JSNM105SS	74	JSPMP3SS	14	JSRM17	9	JSRM90P	10
JSHTB31	119	JSLW7D	87	JSNM105SS316	74	JSPMP445SS	15	JSRM17P	10	JSRM95	9
JSHTB33	119	JSLW7L	87	JSNM125SS	74	JSPMP4SS	14	JSRM18	9	JSRM95P	10
JSHTB34	119	JSLW8	87	JSNM125SS316	74	JSPMP55SS	14	JSRM19	9	JSRM97	9
JSHTB35	119	JSLW81	88	JSNM145SS	74	JSPMP785SS	14	JSRM190P	10	JSRM97P	10
JSHTB36	119	JSLW9	88	JSNM45SS	74	JSPMP7SS	14	JSRM19P	10	JSSW10	81
JSHTB37D	117	JSLW91	88	JSNM55SS	74	JSPMP805SS	14	JSRM20	9	JSSW101	81
JSHTB38D	117	JSLW91D	87	JSNM65SS	74	JSPMP995SS	15	JSRM20P	10	JSSW11	81
JSHTB4	119	JSLW92	88	JSNM65SS316	74	JSQ2	78	JSRM21	9	JSSW111	81
JSHTB40	119	JSLW921	88	JSNM85SS	74	JSQ3	78	JSRM21P	10	JSSW12	81
JSHTB41	119	JSLW9D	87	JSNM85SS316	74	JSQ4	78	JSRM22	9	JSSW121	81
JSHTB42	119	JSLW9L	87	JSPM1025SS	13	JSQ5	78	JSRM22P	10	JSSW121D	80
JSHTB44	119	JSLW9TW	88	JSPM1035SS	13	JSQ6	78	JSRM23	9	JSSW12D	80
JSHTB44D	117	JSMX1	180	JSPM1045SS	13	JSQ7	78	JSRM23P	10	JSSW13	81
JSHTB45	119	JSMX125	180	JSPM105SS	13	JSQ8	78	JSRM24	9	JSSW131	81
JSHTB451	119	JSMX2	180	JSPM1155SS	13	JSQ8SS	78	JSRM24P	10	JSSW14	81
JSHTB45D	117	JSMX225	180	JSPM115SS	13	JSQ9	78	JSRM25	9	JSSW141	81
JSHTB46	119	JSMXP35	180	JSPM125SS	13	JSQW73G	92	JSRM25P	10	JSSW14D	80
JSHTB461	119	JSMXP3525	180	JSPM135SS	13	JSQW76G	92	JSRM26	9	JSSW15	81
JSHTB461	119	JSN10	72	JSPM145SS	13	JSRM03	9	JSRM261	10	JSSW151	81
JSHTB46D	117	JSN103316SS	73	JSPM155SS	13	JSRM04	9	JSRM26P	10	JSSW15D	80
JSHTB47	119	JSN10D	71	JSPM165SS	13	JSRM05	9	JSRM27	9	JSSW16	81
JSHTB471	119	JSN11	72	JSPM175SS	13	JSRM10	9	JSRM27P	10	JSSW17	81
JSHTB47D	117	JSN11316SS	73	JSPM185SS	13	JSRM100	9	JSRM28	9	JSSW171	81
JSHTB48	119	JSN11D	71	JSPM195SS	13	JSRM100P	10	JSRM29	9	JSSW181	81
JSHTB48D	117	JSN12	72	JSPM205SS	13	JSRM101	9	JSRM29P	10	JSSW19	81
JSHTB49	119	JSN12316SS	73	JSPM285SS	13	JSRM101P	10	JSRM30	9	JSSW20	81
JSHTB50D	117	JSN13	72	JSPM305SS	12	JSRM102P	10	JSRM30P	10	JSSW201	81
JSHTB59	119	JSN13316SS	73	JSPM3445SS	12	JSRM10P	10	JSRM31	9	JSSW21	81
JSHTB61	119	JSN13D	71	JSPM505SS	12	JSRM11	9	JSRM311	10	JSSW211	81
JSHTB62D	117	JSN14	72	JSPM65SS	12	JSRM11P	10	JSRM31P	10	JSSW22	81

When Searching Stock # Drop "J"

[www.metallics.us](http://www.metallics.us)

# QUICK REFERENCE PRODUCT INDEX

PART #:	PAGE								
JSSW78.....	81	JSTSP41.....	27	JTEK10PV.....	39	JTEKD4.....	42	JTHD50234RH....	180
JSSW781.....	81	JSTSP42.....	27	JTEK114P.....	39	JTEKD146.....	43	JTHDB37158RH...	180
JSSW8.....	81	JSW67.....	80	JTEK11P.....	39	JTEKD145SS.....	44	JTLN1.....	75
JSSW81.....	81	JSW68.....	80	JTEK11PSS.....	39	JTEKD14V.....	41	JTEKD4M.....	42
JSTS10.....	26	JSW69.....	80	JTEK11PV.....	39	JTEKD14V.....	41	JTEKD4SS.....	44
JSTS11.....	26	JSW70.....	80	JTEK12P.....	39	JTEKD15.....	42	JTEKD4V.....	42
JSTS12.....	26	JSW71.....	80	JTEK12PSS.....	39	JTEKD15SS.....	44	JTEKD5.....	42
JSTS13.....	26	JSW72.....	80	JTEK12PV.....	39	JTEKD15V.....	42	JTEKD5163.....	43
JSTS14.....	26	JSW72D.....	80	JTEK12PSS.....	39	JTEKD16.....	41	JTEKD5M.....	42
JSTS1412.....	26	JSW73.....	80	JTEK13P.....	39	JTEKD16V.....	41	JTEKD5SS.....	44
JSTS15.....	26	JSW73D.....	80	JTEK14P.....	39	JTEKD17.....	42	JTEKD5V.....	42
JSTS16.....	26	JSW73G.....	82	JTEK14PSS.....	39	JTEKD17V.....	42	JTEKD6.....	42
JSTS17.....	26	JSW73M.....	80	JTEK14PV.....	39	JTEKD18.....	42	JTEKD63.....	41
JSTS18.....	26	JSW74.....	80	JTEK15P.....	39	JTEKD18SS.....	44	JTEKD64.....	41
JSTS19.....	26	JSW74G.....	82	JTEK15PV.....	39	JTEKD18V.....	42	JTEKD65.....	41
JSTS20.....	26	JSW75.....	80	JTEK16P.....	39	JTEKD19.....	42	JTEKD66.....	41
JSTS21.....	26	JSW75D.....	80	JTEK18P.....	39	JTEKD19SS.....	44	JTEKD6M.....	42
JSTS22.....	26	JSW75G.....	82	JTEK18PV.....	39	JTEKD19V.....	42	JTEKD6SS.....	44
JSTS23.....	26	JSW75M.....	80	JTEK19P.....	39	JTEKD1M.....	41	JTEKD6V.....	42
JSTS24.....	26	JSW76.....	80	JTEK19PSS.....	39	JTEKD1SS.....	44	JTEKD7.....	42
JSTS25.....	26	JSW76D.....	80	JTEK19PV.....	39	JTEKD1V.....	41	JTEKD7M.....	42
JSTS26.....	26	JSW76G.....	82	JTEK1P.....	39	JTEKD2.....	41	JTEKD7SS.....	44
JSTS27.....	26	JSW77.....	81	JTEK1PSS.....	39	JTEKD20.....	43	JTEKD7V.....	42
JSTS28.....	26	JSW77G.....	82	JTEK1PV.....	39	JTEKD20M.....	43	JTEKD8.....	43
JSTS38.....	26	JSW78.....	81	JTEK20P.....	39	JTEKD20SS.....	44	JTEKD82.....	42
JSTS38.....	26	JSW78G.....	82	JTEK20PSS.....	39	JTEKD20V.....	43	JTEKD88.....	42
JSTS50.....	26	JSW79.....	80	JTEK2P.....	39	JTEKD21.....	43	JTEKD8M.....	43
JSTS60.....	26	JSW82.....	81	JTEK2PSS.....	39	JTEKD21SS.....	44	JTEKD8SS.....	44
JSTSP10.....	27	JSW82G.....	82	JTEK2PV.....	39	JTEKD2IV.....	43	JTEKD8V.....	43
JSTSP11.....	27	JSWBR12.....	82	JTEK32P.....	39	JTEKD22.....	43	JTEKD9.....	43
JSTSP12.....	27	JSWBR14.....	81	JTEK34P.....	39	JTEKD22SS.....	44	JTEKD90.....	43
JSTSP125.....	27	JSWBR16.....	81	JTEK3P.....	39	JTEKD22V.....	43	JTEKD91AF.....	42
JSTSP13.....	27	JSWBR34.....	82	JTEK3PSS.....	39	JTEKD23.....	42	JTEKD92SS.....	44
JSTSP14.....	27	JSWBR38.....	82	JTEK3PV.....	39	JTEKD23SS.....	44	JTEKD93SS.....	44
JSTSP15.....	27	JSWBR516.....	81	JTEK4P.....	39	JTEKD24.....	42	JTEKD94.....	43
JSTSP16.....	27	JSWBR58.....	82	JTEK4PSS.....	39	JTEKD25.....	41	JTEKD99.....	43
JSTSP17.....	27	JSWBR6.....	81	JTEK4PV.....	39	JTEKD26.....	41	JTEKD9M.....	43
JSTSP18.....	27	JSWBR68.....	81	JTEK71P.....	39	JTEKD27.....	41	JTEKD9SS.....	44
JSTSP19.....	27	JSWBR8.....	81	JTEK71PSS.....	39	JTEKD27SS.....	44	JTEKD9V.....	43
JSTSP20.....	27	JSWN1.....	82	JTEK7P.....	39	JTEKD28.....	42	JTEKDHH19.....	40
JSTSP21.....	27	JSWN2.....	82	JTEK7PSS.....	39	JTEKD29SS.....	44	JTEKDHH19M.....	40
JSTSP22.....	27	JSWN6.....	82	JTEK7PV.....	39	JTEKD2M.....	41	JTEKDHH6.....	40
JSTSP23.....	27	JSWN73.....	82	JTEK82P.....	39	JTEKD2SS.....	44	JTEKDHH6M.....	40
JSTSP24.....	27	JSWN74.....	82	JTEK8P.....	39	JTEKD2V.....	41	JTEKDHH7.....	40
JSTSP25.....	27	JSWN75.....	82	JTEKD1.....	41	JTEKD3.....	42	JTEKDHH7M.....	40
JSTSP26.....	27	JSWN8.....	82	JTEKD10.....	43	JTEKD30.....	43	JTEKDM416.....	44
JSTSP27.....	27	JSYA14.....	153	JTEKD10SS.....	44	JTEKD30SS.....	44	JTEL1024BLK.....	25
JSTSP28.....	27	JSYA316.....	153	JTEKD10V.....	43	JTEKD31.....	43	JTEL1024BLK.....	185
JSTSP29.....	27	JSYA516.....	153	JTEKD11.....	43	JTEKD32.....	43	JTEL1032.....	24
JSTSP30.....	27	JTA14134.....	139	JTEKD114.....	42	JTEKD32M.....	43	JTEL1032.....	185
JSTSP31.....	27	JTA14212.....	139	JTEKD114SS.....	44	JTEKD32SS.....	44	JTEL103234.....	24
JSTSP32.....	27	JTA14314.....	139	JTEKD114V.....	42	JTEKD32V.....	43	JTEL103234.....	185
JSTSP33.....	27	JTA38314.....	139	JTEKD11V.....	43	JTEKD33.....	43	JTEL1032BLK.....	25
JSTSP34.....	27	JTA38334.....	139	JTEKD12.....	42	JTEKD34.....	43	JTEL1032BLK.....	185
JSTSP35.....	27	JTA38334.....	139	JTEKD12212.....	43	JTEKD34V.....	43	JTEL1224.....	24
JSTSP35.....	27	JTA38412.....	139	JTEKD12212SS.....	44	JTEKD35.....	43	JTEL1224.....	185
JSTSP36.....	27	JTA516212.....	139	JTEKD12SS.....	44	JTEKD36.....	43	JTEL1224BLK.....	25
JSTSP37.....	27	JTA516314.....	139	JTEKD12V.....	42	JTEKD37.....	43	JTEL1224BLK.....	185
JSTSP38.....	27	JTA516334.....	139	JTEKD13.....	42	JTEKD37SS.....	44	JTEL1228.....	24
JSTSP39.....	27	JTEK10P.....	39	JTEKD13V.....	42	JTEKD38.....	43	JTEL1228.....	185
JSTSP40.....	27	JTEK10PSS.....	39	JTEKD14.....	41	JTEKD3M.....	42	JTEL1228.....	185
				JTEKD14.....	41	JTEKD3V.....	42	JTHD25112RH.....	180

When Searching Stock # Drop "J"

[www.metallics.us](http://www.metallics.us)



# QUICK REFERENCE PRODUCT INDEX



PART #:	PAGE										
JTS1034SSD	147	JTS3121SSD	146	JTS48	31	JTSF10	25	JTSP86	30	JTTS36	28
JTS103D	146	JTS312D	146	JTS49	31	JTSF101	25	JTSP87	30	JTTS37	28
JTS103G	150	JTS312SS	149	JTS51	31	JTSF11	25	JTSS1	28	JTTS38	27
JTS103SS	148	JTS32	32	JTS510G	150	JTSF12	25	JTSS10	28	JTWA144	174
JTS103SSD	146	JTS3218	148	JTS516234D	146	JTSF13	25	JTSS10SS	29	JTWA145	174
JTS1044SS	149	JTS32181SSD	147	JTS5163D	146	JTSF14	25	JTSS11	28	JTWA200	175
JTS11	30	JTS3218D	146	JTS5164D	146	JTSF15	25	JTSS11SS	29	JTWA57	175
JTS1134	148	JTS3218SS	149	JTS51M	31	JTSF16	25	JTSS12	28	JTXW381Z	46
JTS11340SS	149	JTS3218SSD	146	JTS52	32	JTSF17	25	JTSS2	28	JW107	85
JTS11341SSD	147	JTS3234	148	JTS5312	148	JTSF18	25	JTSS25	28	JW110	85
JTS1134D	146	JTS32340SS	149	JTS53120SS	149	JTSF18SS	26	JTSS25SS	29	JW111	85
JTS1134G	150	JTS32341SSD	147	JTS53121SSD	147	JTSF19	25	JTSS27	28	JW111SS	86
JTS1134SS	148	JTS3234D	146	JTS5312D	146	JTSF20	25	JTSS27SS	29	JW112	85
JTS1134SSD	146	JTS3234G	150	JTS5312G	150	JTSF21	25	JTSS28	28	JW112SS	86
JTS12	30	JTS3234SS	149	JTS5312SS	149	JTSF22	25	JTSS28SS	29	JW113	85
JTS1214	148	JTS3234SSD	146	JTS5312SSD	147	JTSF23	25	JTSS29	28	JW113D	85
JTS1214D	146	JTS33	32	JTS54	32	JTSF24	25	JTSS29SS	29	JW113M	85
JTS1214SS	148	JTS3312G	150	JTS5412	148	JTSF25	25	JTSS3	28	JW113SS	86
JTS1214SSD	146	JTS3312SSD	146	JTS54120SS	149	JTSF26	25	JTSS30	28	JW113SSD	85
JTS12M	30	JTS33M	32	JTS54121SSD	147	JTSF27	25	JTSS30SS	29	JW114	85
JTS13	30	JTS34	32	JTS5412D	146	JTSF28	25	JTSS31	28	JW1141SS	86
JTS14	30	JTS35	32	JTS5412G	150	JTSF29	25	JTSS31SS	29	JW114D	85
JTS144SS	149	JTS36	32	JTS5412SS	149	JTSF29V	25	JTSS32	28	JW114SS	86
JTS14M	30	JTS3612SS	149	JTS55	32	JTSF30	25	JTSS33	28	JW115	85
JTS15	30	JTS37	32	JTS56	32	JTSF31	25	JTSS34	28	JW115SS	86
JTS15M	30	JTS38	31	JTS57	32	JTSF32	26	JTSS35	28	JW116	85
JTS17	31	JTS380G	150	JTS59	32	JTSF33	26	JTSS36	28	JW1161SS	86
JTS18	31	JTS383G	150	JTS6	30	JTSF34	26	JTSS37	28	JW116D	85
JTS18M	31	JTS385SS	149	JTS60	32	JTSF35	26	JTSS4	28	JW116G	86
JTS19	31	JTS39	31	JTS607	148	JTSF36	26	JTSS5	28	JW116SS	86
JTS2	30	JTS4	30	JTS607G	150	JTSF37	26	JTSS6	28	JW117	85
JTS20	31	JTS40	31	JTS607SS	149	JTSF38	25	JTSS7	28	JW1171SS	86
JTS21	31	JTS4071SSD	147	JTS61	32	JTSF39	25	JTSS7SS	28	JW117D	85
JTS21M	31	JTS407SS	149	JTS62	32	JTSF39SS	26	JTSS8	28	JW117SS	86
JTS22	31	JTS407SSD	147	JTS63	32	JTSF40	26	JTSS81	28	JW118	85
JTS23	31	JTS42	31	JTS6414	148	JTSF41	26	JTSS81SS	29	JW118SS	86
JTS24	31	JTS4234	148	JTS64141SSD	147	JTSF42	25	JTSS83	28	JW119	85
JTS25	31	JTS42341SSD	147	JTS6414D	146	JTSF43	25	JTSS83V	28	JW1191SS	86
JTS25M	31	JTS4234D	146	JTS6414SS	149	JTSF44	25	JTSS8SS	28	JW119D	85
JTS26	31	JTS4234G	150	JTS6414SSD	147	JTSF45	25	JTSS9	28	JW119G	86
JTS27	31	JTS4234SS	149	JTS6434	148	JTSF57	26	JTSS9SS	28	JW119SS	86
JTS27M	31	JTS4234SSD	147	JTS64341SSD	147	JTSF59	26	JTTS12	27	JW119SSD	85
JTS27V	31	JTS4334	148	JTS6434D	146	JTSF60	26	JTTS14	27	JW119SSV	86
JTS28	31	JTS43340SS	149	JTS6434G	150	JTSF61	26	JTTS14M	27	JW120	86
JTS28V	31	JTS43341SSD	147	JTS6434SS	149	JTSF62	26	JTTS15	27	JW1201	86
JTS29	31	JTS4334D	146	JTS6434SSD	147	JTSF7	25	JTTS18	27	JW12011SS	86
JTS29M	31	JTS4334SS	149	JTS65	30	JTSF7SS	26	JTTS20	27	JW1201SS	86
JTS3	30	JTS4334SSD	147	JTS6512D	146	JTSF9	25	JTTS21	27	JW1201SSD	85
JTS30	31	JTS44	31	JTS6614	148	JTSP12	30	JTTS22	27	JW120SS	86
JTS303	148	JTS4414	148	JTS6614D	146	JTSP14	30	JTTS23	27	JW121	86
JTS3031SSD	147	JTS44141SSD	147	JTS6614G	150	JTSP16	30	JTTS24	27	JW121SS	86
JTS3033SS	149	JTS4414316SS	149	JTS7	30	JTSP20	30	JTTS25	28	JW122	85
JTS303D	146	JTS4414D	146	JTS80	31	JTSP23	30	JTTS27	28	JW1221SS	86
JTS303SS	149	JTS4414G	150	JTS81	31	JTSP27	30	JTTS28	28	JW122SS	86
JTS303SSD	146	JTS4414SS	149	JTS82	32	JTSP28	30	JTTS29	28	JW123	85
JTS30M	31	JTS4414SSD	147	JTS83	32	JTSP29	30	JTTS30	28	JW1231SS	86
JTS31	31	JTS4512	148	JTS84	31	JTSP30	30	JTTS31	28	JW123SS	86
JTS312	148	JTS4512G	150	JTS85	30	JTSP39	30	JTTS33	28	JW124	85
JTS31211SSD	147	JTS4512SS	149	JTS85	31	JTSP43	30	JTTS34	28	JW125	85
JTS3121SS	149	JTS47	32	JTS9	31	JTSP85	30	JTTS35	28	JW127	85

When Searching Stock # Drop "J"

[www.metallics.us](http://www.metallics.us)



# QUICK REFERENCE PRODUCT INDEX

PART #:	PAGE										
JW1271SS	86	JWW87L	82	LCS5840SS	131	M50090	166	MAU38	161	MN112TM	196
JW127SS	86	JWW88	82	LCS5850	131	M50092	166	MAU516	161	MN114J	195
JW128	86	JZSA1/jar	163	LCS5850SS	131	M50094	166	MAU8	161	MN12C	194
JW128G	86	JZSAL2	163	LCS5860	131	M50096	166	MAU81	161	MN16C	194
JW128SS	86			LCS5860SS	132	M50098	166	MAVSG	202	MN16DP	195
JWDS1C	54	<b>K</b>		LCS5865	131	M50100	166	MAVSR	202	MN16HG	195
JWDS1V	54	KL600	177	LCS5865SS	132	M50136	166	MAVSY	202	MN16S	195
JWDS2C	54	KST100SS	197	LCS5880	131	M50138	166	MBC12	169	MN16S50B	195
JWDS3C	54	KST40SS	197	LCS5880SS	132	M50140	166	MBC14	169	MN16SP	195
JWDS4C	54			LCSX1230	132	M50364	166	MBC38	169	MN1TM	196
JWDS4V	54	<b>L</b>		LCSx1240	132	M50368	166	MBC58	169	MN20D50	194
JWDS6C	54	LCS1212	131	LCSx1250	132	M50370	166	MBGTDI1	215	MN212TM	196
JWDW1C	53	LCS1213	131	LCSX1260	132	M50500	166	MBGTDM1	215	MN2TM	196
JWDW2C	53	LCS1214	131	LCSX1265	132	M50502	166	MBHC33160	114	MN30D50	194
JWDW3C	53	LCS1215	131	LCSX1280	132	M50504	166	MBR100WS	181	MN3TM	196
JWDW4C	53	LCS1230	131	LCSX3460	132	M50506	166	MBR125	181	MN4F	195
JWN2SS	78	LCS1230SS	131	LCSX3485	132	M50570	166	MBR125B	181	MN6F	195
JWN3	78	LCS1240	131	LCSX3830	132	M50574	166	MBR150	181	MN6HG	195
JWN3SS	78	LCS1240SS	131	LCSx3850	132	M50578	166	MBR150WS	181	MN7HGB	195
JWN4	78	LCS1240SS	131	LCSX3860	132	M50612	166	MBR200	181	MN8C	194
JWN4SS	78	LCS1250	131	LCSX5850	132	M50614	166	MBR200WS	181	MN8DP	195
JWN5	78	LCS1250SS	131	LCSX5860	132	M50620	166	MDR114	193	MN8HG	195
JWN6	78	LCS1260	131	LCSX5865	132	M50622	166	MDR12	193	MN8S	195
JWN6SS	78	LCS1260SS	131	LCSX5880	132	M50626	166	MDR58	193	MN8TG	195
JWN7	78	LCS1265	131	LW1725M	87	M50630	166	MDR78	193	MPD1	223
JWN7SS	78	LCS1265SS	131	LW1745M	87	M6206	143	MEF1060	162	MPD3	223
JWN8	78	LCS1280	131	LW174G5M	88	M6304SD	143	MEF632	162	MRST1420	140
JWN8SS	78	LCS1280SS	131	LW174M	87	M6306SD	143	MEF838	162	MRST3816	140
JWN9	78	LCS14178	131	LW175-2M	87	M6308SD	143	MEF860	162	MSC15	196
JWNCF2	78	LCS14234	131	LW13-5M	89	M6322	142	MGRK4SS	49	MSC20	196
JWNCF3	78	LCS14300	131	LWIX2	89	M6335	142	MHC24	214	MSC25	196
JWNCF4	78	LCS14350	131	LWIX58	89	M6400SD	141	MHC28	214	MSC35	196
JWNCF5	78	LCS1440	131	LWK1	80	M6401SD	141	MHC32	214	MSC40	196
JWNCF6	78	LCS3410	131	<b>M</b>		M6403SD	141	MHC36	214	MSC50	170
JWNCF7	78	LCS3440	131	M10	211	M6404SD	141	MHC48	214	MSC50R	170
JWNCF8	78	LCS3440SS	132	M10B	211	M6407SD	141	MHC52	214	MSC75	170
JWNCF9	78	LCS3450	131	M10BB	211	M7206SD	150	MHC6	214	MSC75R	170
JWW79	82	LCS3450SS	132	M14B	211	M7402SD1	150	MHC60	214	MSCU	170
JWW80	82	LCS3460SS	132	M151	198	M7409SD1	150	MHC64	214	MSCUR	170
JWW80G	83	LCS3470	131	M16B	211	M7412SD1	150	MHD14	130	MSCW12	92
JWW80M	82	LCS3470SS	132	M1B	211	M7413SD1	150	MHD14	212	MSCW12SS	92
JWW80SS	83	LCS3485	131	M2202SD	130	M9320	143	MHD56	130	MSCW14SS	92
JWW81	82	LCS3485SS	132	M2220SD	130	M9322	143	MHD56	212	MSCW34	92
JWW81M	82	LCS3816	131	M425SD	143	M9323	143	MHTB1650SS	113	MSCW38	92
JWW81SS	83	LCS3816SS	131	M427SD	143	MAN101	162	MISTG1	215	MSCW38SS	92
JWW82	82	LCS3824	131	M50012	166	MAN14	162	MJP1420	162	MSCW516	92
JWW82G	83	LCS3830	131	M50016	166	MAN14M	162	MJPMSQ	162	MSHC305316SS	24
JWW82PL	83	LCS3830SS	131	M50022	166	MAN1680	162	MKL100	177	MSNR1213	77
JWW82SS	83	LCS3840	131	M50023	166	MAN38	162	MLMP18	217	MSNR1213D	77
JWW83	82	LCS3840SS	131	M50026	166	MAN516	162	MLMPB1	217	MSNR1420	77
JWW83BLACK	83	LCS3840SS	131	M50032	166	MAN8	162	MLMPLUG58	217	MSNR1420D	77
JWW83PL	83	LCS3850	131	M50034	166	MAN81	162	MLMT4	217	MSNR3816	77
JWW83SS	83	LCS3850SS	131	M50038	166	MAQ10	161	MLMT6	217	MSNR3816D	77
JWW84	82	LCS3860	131	M50040	166	MAQ14	161	MN10C	194	MSNRCN1213	77
JWW84G	83	LCS3860SS	131	M50044	166	MAQ316	161	MN10HG	195	MSNRCN1420	77
JWW85	82	LCS3860SS	131	M50048	166	MAQ38	161	MN10S	195	MSNRCN3816	77
JWW86	82	LCS5810	131	M50070	166	MAQ516	161	MN112HGJST	195	MSNS1213	77
JWW87	82	LCS5840	131	M50080	166	MAQ81	161	MN112J	195	MSNS1420	77
JWW87G	83					MAU10	161	MN112R	195	MSNS3816	77
						MAU14	161	MN112R25	195	MSOC14	200

When Searching Stock # Drop "J"

[www.metallics.us](http://www.metallics.us)

PART #:	PAGE										
MSTD2061.....	201	MWDH114K.....	134	N167V.....	70	NHSD5.....	204	P2P2B.....	210	PT40BULK.....	183
MSTD2061MINI..	201	MWDM1.....	173	N168CCL.....	70	NHSD50.....	205	P2S8.....	210	PT40J.....	183
MSTD2083.....	201	MWDOBLK1141M..	135	N174G.....	73	NHSD6.....	204	P2S8B.....	210	PT40K.....	183
MSTD2083MINI..	201	MWDOBLK114J..	135	NA140M.....	152	NHSD6E.....	204	PB2.....	130	PT45.....	184
MSTD2086.....	201	MWDOBLK114K..	135	NA14110M.....	152	NHSD7.....	204	PB2.....	212	PT45M.....	184
MSW23M.....	91	MWDOBR1141M..	135	NA1414V.....	152	NHSD77E.....	204	PB3.....	130	PT50.....	183
MSW3125SS316B..	84	MWDOBR114J.....	135	NA1415M.....	152	NHSD7E.....	204	PB3.....	212	PTS30.....	183
MSWP120.....	91	MWDOBR114K.....	135	NA141M.....	152	NHSD8.....	204	PCS125.....	199	PTS30C.....	183
MSWS35B.....	91	MWDOW1141M..	135	NAP1.....	196	NHSD8E.....	204	PCS125V.....	199	PTS40.....	183
MT208.....	211	MWDOW114J.....	135	NHSD10.....	204	NHSD9.....	204	PCS345.....	199	PTS408.....	183
MT208B.....	211	MWDOW114K.....	135	NHSD10E.....	204	NHSD9E.....	204	PCS204.....	187	PTS40C.....	183
MT208L.....	211	MWDOZ1141M....	135	NHSD11.....	204	NHSD9E.....	204	PCS212.....	187		
MT208L4.....	211	MWDOZ114J.....	135	NHSD11E.....	204	NHSD9E.....	204	PCS234.....	187		
MT208L4B.....	211	MWDOZ114K.....	135	NHSD11E.....	204	NHSD9E.....	204	PCS244.....	187		
MT208L6.....	211	MWDPBLK1141M..	135	NHSD14.....	204	NHSD9E.....	204	PCS254.....	187	QB1.....	220
MT208L6B.....	211	MWDPBLK114J....	135	NHSD16.....	204	NHSD9E.....	204	PCS264.....	187	QB10.....	220
MT208LB.....	211	MWDPBLK114K..	135	NHSD17.....	204	NHSD9E.....	204	PCS274.....	187	QB11.....	220
MT209B.....	211	MWDPBLKP1121M..	135	NHSD18.....	204	NHSD9E.....	204	PCS284.....	187	QB12.....	220
MT210.....	211	MWDPBLKP112J..	135	NHSD19.....	204	NHSD9E.....	204	PCS284.....	187	QB13.....	220
MT210B.....	211	MWDPBLKP112K..	135	NHSD19.....	204	NHSD9E.....	204	PCS294.....	187	QB13.....	220
MT210L.....	211	MWDPBR1141M..	135	NHSD1E.....	204	NK1.....	74	PD4112.....	141	QB14.....	220
MT210L4.....	211	MWDPBR114J.....	135	NHSD2.....	204	NP400.....	192	PD8134.....	141	QB15.....	220
MT210L4B.....	211	MWDPBR114K.....	135	NHSD20.....	204	NP400B.....	192	PDS1B.....	54	QB16.....	220
MT210L6.....	211	MWDPBZ1121M..	135	NHSD20E.....	204	NP401.....	192	PDS1M.....	54	QB17.....	220
MT210L6B.....	211	MWDPBZ112J.....	135	NHSD21.....	204	NP580.....	192	PDW1B.....	54	QB2.....	220
MT210LB.....	211	MWDPBZ112K.....	135	NHSD21.....	204	NP600.....	192	PDW1M.....	54	QB20.....	220
MT212.....	211	MWDPW1121M....	135	NHSD22.....	204	NP660.....	192	PFMA2201050.....	177	QB21.....	220
MT212B.....	211	MWDPW112J.....	135	NHSD22E.....	204	NP800.....	192	PFMA2201050.....	179	QB22.....	220
MT212L.....	211	MWDPW112K.....	135	NHSD23.....	205	NPL12.....	192	PFMD149100.....	179	QB23.....	220
MT212L4.....	211	MWDPW1141M....	135	NHSD24.....	205	NPL188.....	192	PFMD1491050.....	179	QB24.....	220
MT212L4B.....	211	MWDPW114J.....	135	NHSD25.....	205	NS1812.....	192	PFMD1491100.....	179	QB25.....	220
MT212L6.....	211	MWDPW114K.....	135	NHSD25E.....	204	NS1816.....	192	PFMD2201150.....	179	QB26.....	220
MT212L6B.....	211	MWDPZ1141M....	135	NHSD25SE.....	204	NS2412.....	192	PFMD2201200.....	179	QB27.....	220
MT212LB.....	211	MWDPZ114J.....	135	NHSD26.....	205	NS2416.....	192	PFMD2201250.....	179	QB28.....	220
MT214L.....	211	MWDPZ114K.....	135	NHSD26E.....	204	NS2418.....	192	PFMD2201300.....	179	QB29.....	220
MTECH32.....	201	MWDS1141M.....	135	NHSD27.....	205	NT12.....	165	PFMD2201350.....	179	QB3.....	220
MTECH32TR.....	201	MWDS114J.....	135	NHSD28.....	205	NT14.....	165	PP100.....	194	QB30.....	220
MTKQ.....	209	MWDS114K.....	135	NHSD28E.....	204	NT14.....	165	PP50.....	194	QB31.....	220
MTKQ10.....	208	MWDWS114K.....	135	NHSD29.....	205	NT1425.....	165	PP75.....	194	QB32.....	220
MTKQ9.....	208	MWDWW1121M....	134	NHSD29E.....	204	NT1425J JAR.....	165	PSA1J/jar.....	164	QB33.....	220
MTW12.....	172	MWDWW112J.....	134	NHSD29SE.....	204	NT14C.....	165	PSA1K/box.....	164	QB34.....	220
MTW123M.....	172	MWDWW112K.....	134	NHSD3.....	204	NT316.....	165	PSA1M/box.....	164	QB35.....	220
MTW124M.....	172	MWDWW2121M....	134	NHSD30.....	205	NT316100.....	165	PSAL2J/jar.....	164	QB4.....	220
MTW14.....	172	MWDWW212J.....	134	NHSD30E.....	204	NT31625.....	165	PSAL2K/box.....	164	QB5.....	220
MTW14M.....	172	MWDWW212K.....	134	NHSD31.....	205	NT38.....	165	PST100.....	198	QB6.....	220
MTW16.....	172	MWDWW2141M....	134	NHSD31E.....	204	NT3815J JAR.....	165	PST100I.....	198	QB7.....	220
MTW16SS1LB.....	172	MWDWW214J.....	134	NHSD32.....	205	NT3825.....	165	PST40.....	198	QB8.....	220
MTW16SSP.....	172	MWDWW214K.....	134	NHSD33.....	205	NYN1635M.....	75	PST40I.....	198	QB9.....	220
MTW17.....	172	MWDWW21M.....	134	NHSD35.....	205	NYN163B.....	75	PT30.....	183	QCSH1.....	127
MTW1725.....	172	MWDWW2J.....	134	NHSD35E.....	204	NYN164SSB.....	76	PT30B.....	184	QCSH10.....	127
MTW18.....	172	MWDWW2K.....	134	NHSD36.....	205	NYNK1.....	75	PT30M.....	183	QCSH10B.....	127
MTW9.....	172			NHSD36E.....	204			PT35.....	184	QCSH1B.....	127
MTW9163.....	172	<b>N</b>		NHSD37.....	205	<b>O</b>		PT40.....	183	QCSH2.....	127
MWCA100.....	152	N1635M.....	70	NHSD37E.....	204	ORG1.....	215	PT4010.....	184	QCSH20.....	127
MWCA25.....	152	N163B.....	70	NHSD39.....	205	ORG2.....	215	PT4010V.....	184	QCSH20B.....	127
MWCA50.....	152	N1651M.....	70	NHSD4.....	204			PT4012.....	185	QCSH2B.....	127
MWCA500.....	152	N1651M.....	70	NHSD41.....	205	<b>P</b>		PT4012V.....	185	QCSH3.....	127
MWD1.....	173	N165B.....	70	NHSD43.....	205	P1P1B.....	210	PT4015.....	185	QCSH30.....	127
MWDH1141M.....	134	N1661M.....	70	NHSD43E.....	204	P2P2.....	210	PT408.....	184	QCSH30B.....	127
MWDH114J.....	134	N166B.....	70	NHSD44.....	205			PT408FS.....	184	QCSH3B.....	127
		N166GB.....	73	NHSD45E.....	204			PT40B.....	184	QCSH40.....	127

When Searching Stock # Drop "J"

[www.metallics.us](http://www.metallics.us)

# QUICK REFERENCE PRODUCT INDEX

PART #:	PAGE										
QCSH40B.....	127	QK1M.....	36	RCA12214.....	144	RSB100.....	12	SAD21.....	212	SD1231678.....	222
QCSHK1.....	127	QK205M.....	37	RCA381.....	144	RSB100S.....	12	SBH16B.....	108	SD12716118.....	222
QCSHK2.....	127	QK20M.....	37	RCT2.....	167	RSB101.....	12	SBH1M.....	107	SD131812.....	222
QDS152.....	35	QK254M5V.....	37	RCT25.....	167	RSB101S.....	12	SBH20.....	110	SD14138.....	222
QDS152V.....	35	QK258M.....	37	RCT26.....	167	RSB102.....	12	SBH325.....	109	SD278118.....	222
QDS153.....	35	QK25M.....	37	RCT26G.....	167	RSB103.....	12	SBH355.....	110	SD34.....	222
QDS153V.....	35	QK30M.....	37	RCT26SS.....	167	RSB103S.....	12	SBH357.....	109	SD631612.....	222
QDS154.....	35	QK510M.....	36	RCT27.....	167	RSB104.....	12	SBH359.....	109	SD78.....	222
QDS156.....	35	QK512M.....	36	RCT27SS.....	167	RSB104S.....	12	SBH60.....	110	SD91434.....	222
QDS158.....	35	QK515M.....	36	RCT28.....	167	RSB105.....	12	SBH67.....	109	SDCP3.....	222
QDS171.....	35	QK55M.....	36	RCT28G.....	167	RSB106.....	12	SBH671.....	110	SDLC1.....	174
QDS172.....	35	QK5M.....	36	RCT28M.....	167	RSB116.....	12	SBH672.....	111	SDLC3.....	174
QDS174.....	35	QK60M.....	37	RCT28SS.....	167	RSB116.....	12	SBH674.....	111	SDS10.....	192
QDS181.....	35	QKK1.....	65	RCT28SS316.....	167	RSB17.....	12	SBH680.....	111	SDS111610.....	222
QDS181V.....	35	QTEKD1.....	40	RCT28V.....	167	RSB18.....	12	SBH760.....	111	SDS1212.....	222
QDS182.....	35	QTEKD12.....	41	RCT29.....	167	RSB19.....	12	SBH805.....	111	SDS1218.....	222
QDS183.....	35	QTEKD12V.....	41	RCT29C.....	167	RSB20.....	12	SBH90.....	109	SDS1224.....	222
QDS184.....	35	QTEKD13.....	41	RCT29G.....	167	RSB21.....	12	SBH91.....	109	SDS1229SPD.....	222
QDS185.....	35	QTEKD13V.....	41	RCT29SS.....	167	RSB22.....	12	SBH941.....	111	SDS1236SPD.....	222
QDS185V.....	35	QTEKD14.....	40	RCT29SS316.....	167	RSB63.....	12	SBH943.....	111	SDS1265.....	221
QDS80.....	35	QTEKD14V.....	40	RCT30.....	167	RSB66.....	12	SBH951.....	111	SDS129.....	222
QDSK10.....	65	QTEKD17.....	40	RCT30G.....	167	RSB72.....	12	SBH96.....	109	SDS1412.....	221
QK1-5M.....	36	QTEKD17M.....	40	RCT30SS.....	167	RSB72SS.....	12	SBH981.....	111	SDS1420.....	221
QK10-5M.....	36	QTEKD17V.....	40	RCT30SS316.....	167	RSB78.....	12	SBH982.....	110	SDS1445.....	221
QK10B.....	36	QTEKD18.....	41	RCT31.....	167	RSB85.....	12	SBH983.....	109	SDS1465.....	221
QK10M.....	36	QTEKD18M.....	41	RCT33.....	167	RSB86.....	12	SBH984.....	109	SDS149.....	221
QK1510M.....	36	QTEKD18V.....	41	RCT35.....	167	RSB89.....	12	SBH9845.....	109	SDS18.....	222
QK155M.....	36	QTEKD19.....	41	RCTL26.....	167	RSB90.....	12	SBH985.....	110	SDS1B.....	52
QK158M.....	36	QTEKD19M.....	41	RCTL28.....	167	RSB91.....	12	SBH986.....	110	SDS1M.....	52
QK15GR10M.....	38	QTEKD19V.....	41	RCTL29.....	167	RSB92.....	12	SBH9865.....	110	SDS20.....	192
QK15GR8M.....	38	QTEKD1V.....	40	RCTR27.....	167	RSB93.....	12	SBH987.....	110	SDS30.....	192
QK15GRM.....	38	QTEKD2.....	40	RCTR28.....	167	RSB94.....	12	SBH988.....	110	SDS31645.....	221
QK15M.....	36	QTEKD20.....	41	RCTR29.....	167	RSB95.....	12	SBH989.....	110	SDS31665.....	221
QK15W10M.....	38	QTEKD20V.....	41	RCTR5812.....	167	RSB99.....	12	SBH99.....	109	SDS3168.....	221
QK15W8M.....	38	QTEKD2V.....	40	RDS3M.....	55	RSBK1.....	69	SBHK1.....	115	SDS348.....	222
QK15WM.....	38	QTEKD3.....	40	RDS4M.....	55	RSBK2.....	69	SBHK1213.....	115	SDS3812.....	221
QK1610M.....	37	QTEKD3V.....	40	RDS5M.....	55	RSBK212.....	69	SBHK1420.....	115	SDS3865.....	221
QK168M.....	37	QTEKD4.....	40	RDS5V.....	55	RSBK3.....	69	SBHK3816.....	115	SDS388.....	221
QK16GR-10M.....	38	QTEKD4V.....	40	RDS6M.....	55	RSBK4.....	69	SBW34.....	81	SDS389.....	221
QK16GR8M.....	38	QTEKD5.....	40	RDS6V.....	55	RSDB1B.....	56	SCH100.....	187	SDS3B.....	52
QK16GRM.....	38	QTEKD5M.....	40	RDS7M316SS.....	55	RSDB1V.....	56	SCH125E.....	187	SDS3M.....	52
QK16M.....	36	QTEKD5V.....	40	RLC10.....	177	RSDB2B.....	56	SCH125R.....	187	SDS4B.....	52
QK16W-10M.....	38	QTEKD6.....	40	RLC5.....	177	RSDB2V.....	56	SCH150.....	187	SDS4M.....	52
QK16W8M.....	38	QTEKD6M.....	40	RLC500.....	177	RSDB3B.....	56	SCH200.....	187	SDS5166.....	221
QK16WM.....	38	QTEKD6V.....	40	RLCK10.....	177	RSDB3V.....	56	SCH250.....	187	SDS53265.....	221
QK1710M.....	37	QTEKD7.....	40	RLCK5.....	177	RSDB4B.....	56	SCH300.....	187	SDS5865.....	222
QK175M.....	37	QTEKD7M.....	41	RM129SLT.....	6	RSDB4V.....	56	SCH350.....	187	SDS589.....	222
QK178M.....	37	QTEKD7V.....	40	RM137.....	8	RSDB5B.....	56	SCH400.....	187	SDS5B.....	52
QK17CCL.....	37	QTEKD8.....	41	RM146SLT.....	6	RSDB5V.....	56	SCH50.....	187	SDS5M.....	52
QK17GR10M.....	38	QTEKD8V.....	41	RM147SLT.....	6	RSDB6B.....	56	SCH75.....	187	SDS73265.....	221
QK17GR8M.....	38	QTEKDK1.....	66	RM89-1M.....	7	RSDB6V.....	56	SCT6215.....	197	SDS788.....	222
QK17GRM.....	38			RM89-2M.....	7	RSDB7B.....	56	SCT6215C.....	197	SDS7B.....	52
QK17M.....	37	<b>R</b>		RM89B.....	7	RWAK1.....	154	SCT6215V.....	197	SDS7M.....	52
QK17W10M.....	38			RMK1024.....	68	RWS105B.....	29	SCT6315.....	197	SDS8B.....	52
QK17W8M.....	38	R120.....	92	RMK1032.....	68	RWS710B.....	29	SCT6315C.....	197	SDS9166.....	222
QK17WM.....	38	R121.....	92	RMK1420.....	68	RWS75B.....	29	SCT6315V.....	197	SDS9B.....	52
QK18M.....	36	R122.....	92	RMK632.....	68			SCT6415.....	197	SDS9M.....	52
QK19CCL.....	37	R123.....	92	RMK832.....	68	<b>S</b>		SCT6415C.....	197	SDSB1265.....	221
QK19M.....	37	RA22M.....	153	RND62.....	179			SCT6415V.....	197	SDSB1445.....	221
QK19WM.....	38	RCA12.....	144	RND62.....	180	SAD13.....	212	SD12.....	222	SDSB1465.....	221

When Searching Stock # Drop "J"

[www.metallics.us](http://www.metallics.us)

PART #:	PAGE						
SE10.....	171	SPD381.....	190	SWP612.....	173	TEKSK1.....	68
SE6.....	171	SPD382.....	190	SWP812.....	173	TEL1024BLK.....	25
SE8.....	171	SPD383.....	190	SWPC1212.....	173	TEL1024BLK.....	185
SEDS10.....	213	SPD384.....	190	SWPK1.....	62	TEL1032BLK.....	25
SES4115.....	197	SPD385.....	190	SWPK1.....	139	TEL1032BLK.....	185
SES4215.....	197	SPDK200.....	190	SYA14B.....	153	TEL1032BLKV.....	25
SES4312.....	197	SPK100.....	189			TEL1032BLKV.....	185
SES4412.....	197	SPK101.....	189			TEL1224.....	24
SES4512.....	197	SPK102.....	189			TEL1224.....	185
SES4612.....	197	SPS5151.....	199	<b>T</b>		TEL1224BLK.....	25
SFN1420B.....	76	SPT200.....	191	TBMK1.....	138	TEL1224BLK.....	185
SFN1420SSB.....	77	SPT200W.....	191	TD4112.....	141	TEL1224BLKV.....	25
SGBK.....	202	SPT201.....	191	TDS13.....	213	TEL1224BLKV.....	185
SGH143.....	201	SPT300.....	191	TDS19.....	213	TEL1228.....	24
SGH145.....	201	SPT400.....	191	TEK10PB.....	39	TG9151.....	44
SH3.....	172	SPT812.....	191	TEK11M.....	43	TGA10.....	138
SHK120.....	172	SPT820.....	191	TEK12M.....	42	TGA10J.....	138
SHK15M.....	172	SQW5G.....	92	TEK13M.....	42	TGA10K.....	138
SHK6B.....	172	SQW77G.....	92	TEK1P10M.....	39	TGA12.....	138
SHTB60.....	119	SRM136.....	9	TEK1P5M.....	39	TGA12J.....	138
SHUBC38.....	169	SRMK1.....	63	TEK4PM.....	39	TGA12K.....	138
SLN12.....	170	SSW13B.....	81	TEK7PB.....	39	TGA6.....	138
SLN12C.....	170	SSWK1.....	80	TEKD105M.....	43	TGA6J.....	138
SLN14.....	170	SW70B.....	80	TEKD10M.....	43	TGA6K.....	138
SLN38.....	170	SW71B.....	80	TEKD1210M.....	42	TGA8.....	138
SLN38C.....	170	SW72B.....	80	TEKD125M.....	42	TGA8J.....	138
SLN516.....	170	SW73B.....	80	TEKD1310M.....	43	TGA8K.....	138
SLN58.....	170	SW74B.....	80	TEKD135M.....	42	TGW12212.....	44
SLN58C.....	170	SW74M.....	80	TEKD155M.....	42	TGW9151.....	44
SLNK1.....	169	SW75B.....	80	TEKD15M.....	41	TGW91515M.....	44
SLNK2.....	169	SW75G5M.....	82	TEKD16M.....	41	TGW9151M.....	44
SLSP50.....	190	SW76B.....	80	TEKD175.....	41	TM63.....	20
SLWK1.....	89	SW76M.....	80	TEKD20B.....	43	TM63LP.....	21
SMXB1.....	180	SW77B.....	81	TEKD210M.....	41	TM63M.....	20
SMXK1.....	180	SW77M.....	81	TEKD25B.....	41	TM68.....	20
SN25.....	73	SW78B.....	81	TEKD25M.....	41	TM68LP.....	21
SNK1.....	74	SW80.....	81	TEKD34M.....	43	TM80.....	20
SP173.....	188	swa1236.....	151	TEKD37M.....	43	TM80LP.....	21
SP175.....	188	swa1244.....	151	TEKD44SSB.....	44	TM81.....	20
SP176.....	188	swa1254.....	151	TEKD55B.....	42	TM81LP.....	21
SP177.....	188	swa1270.....	151	TEKD55M.....	42	TM81LP4M.....	21
SP178.....	188	swa3830.....	151	TEKD610M.....	42	TM81LPB.....	21
SP178B.....	188	swa3836.....	151	TEKD65M.....	42	TM82.....	20
SP179.....	188	swa3850.....	151	TEKD675.....	42	TM82LP.....	21
SP180.....	188	swa5850.....	151	TEKD6AL-10M.....	43	TM83.....	20
SP181.....	188	swa5860.....	151	TEKD75M.....	42	TM83LP.....	21
SP182.....	189	swa5870.....	151	TEKD75M.....	42	TM83LP.....	21
SP184.....	189	swa5884.....	151	TEKD7SSM.....	44	TMSK1.....	64
SP190.....	189	SWK1.....	80	TEKD95M.....	43	TP100SFC.....	59
SP191.....	189	SWL1212.....	173	TEKD95M.....	43	TP100SFC.....	59
SP279.....	189	SWL1612.....	173	TEKDH195M.....	40	TP100SFC.....	59
SP280.....	189	SWL612.....	173	TEKDH19B.....	40	TP100SFC.....	59
SP281.....	189	SWLS1210.....	173	TEKDH65M.....	40	TP100SFC.....	59
SP282.....	189	SWLS1212.....	173	TEKDH6B.....	40	TP100SFC.....	59
SP285.....	189	SWLS126.....	173	TEKDH75M.....	40	TP100SFC.....	59
SP286.....	189	SWLS910.....	173	TEKDH7B.....	40	TP101SFC.....	59
SP379.....	188	SWLS912.....	173	TEKDK1.....	66	TP101SFC.....	59
SP382.....	188	SWP1012.....	173	TEKDK1.....	68	TP102SFC.....	59
SPD379.....	190	SWP1212.....	173	TEKDK1.....	68	TP102SFC.....	59
SPD380.....	190	SWP1612.....	173	TEKDK1SS.....	66	TP102SFC.....	59
				TEKDK6.....	66	TP102SFC.....	59
				TEKPK1.....	68	TP102SFC.....	59
				TEKPK1SS.....	63	TP103SFC.....	59
				TEKPK2SS.....	63	TP103SFC.....	59
						TP104SFC.....	59
						TP104SFC.....	59
						TP105SFC.....	59
						TP105SFC.....	59
						TP106SFC.....	59
						TP106SFC.....	59
						TP107SFC.....	59
						TP107SFC.....	59
						TP108SFC.....	59
						TP108SFC.....	59
						TP109SFC.....	59
						TP109SFC.....	59
						TP110SFC.....	59
						TP110SFC.....	59
						TP111SFC.....	59
						TP111SFC.....	59
						TP112SFC.....	59
						TP112SFC.....	59
						TP113SFC.....	59
						TP113SFC.....	59
						TP114SFC.....	59
						TP114SFC.....	59
						TP115SFC.....	59
						TP115SFC.....	59
						TP116SFC.....	60
						TP116SFC.....	60
						TP117SFC.....	60
						TP117SFC.....	60
						TP118SFC.....	60
						TP118SFC.....	60
						TP119SFC.....	60
						TP119SFC.....	60
						TP120SFC.....	60
						TP120SFC.....	60
						TP121SFC.....	60
						TP121SFC.....	60
						TP122SFC.....	59
						TP122SFC.....	59
						TP123SFC.....	59
						TP123SFC.....	59
						TP124SFC.....	57
						TP125SFC.....	59
						TP125SFC.....	59
						TP126SFC.....	59
						TP126SFC.....	59
						TP127SFC.....	59
						TP127SFC.....	59
						TP128SFC.....	59
						TP128SFC.....	59
						TP129SFC.....	59
						TP129SFC.....	59
						TP130SFC.....	59
						TP130SFC.....	59
						TP131SFC.....	59
						TP131SFC.....	59
						TP133SFC.....	60
						TP133SFC.....	60
						TP134SFC.....	60
						TP134SFC.....	60
						TP135SFC.....	60
						TP135SFC.....	60
						TP136SFC.....	60
						TP136SFC.....	60
						TP137SFC.....	60
						TP137SFC.....	60
						TP138SFC.....	60
						TP138SFC.....	60
						TP139SFC.....	60
						TP139SFC.....	60
						TP140SFC.....	60
						TP140SFC.....	60
						TP141SFC.....	60
						TP141SFC.....	60
						TP142SFC.....	60
						TP142SFC.....	60
						TP143SFC.....	60
						TP143SFC.....	60
						TP144SFC.....	60
						TP144SFC.....	60
						TP199SFC.....	59
						TP199SFC.....	59
						TP200SFC.....	59
						TP200SFC.....	59
						TP201SFC.....	59
						TP201SFC.....	59
						TP202SFC.....	59
						TP202SFC.....	59
						TP203SFC.....	59
						TP203SFC.....	59
						TP204SFC.....	59
						TP204SFC.....	59
						TP205SFC.....	59
						TP205SFC.....	59
						TP206SFC.....	59
						TP206SFC.....	59
						TP207SFC.....	59
						TP207SFC.....	59
						TP208SFC.....	59
						TP208SFC.....	59
						TP209SFC.....	59
						TP209SFC.....	59
						TP210SFC.....	59
						TP210SFC.....	59
						TP212SFC.....	59
						TP212SFC.....	59
						TP212SFC.....	59
						TP213SFC.....	59
						TP213SFC.....	59
						TP214SFC.....	59
						TP214SFC.....	59
						TP215SFC.....	59
						TP215SFC.....	59
						TP216SFC.....	60
						TP216SFC.....	60
						TP217SFC.....	60
						TP217SFC.....	60
						TP218SFC.....	60
						TP218SFC.....	60
						TP219SFC.....	60
						TP219SFC.....	60
						TP220SFC.....	60
						TP220SFC.....	60

When Searching Stock # Drop "J"

[www.metallics.us](http://www.metallics.us)



# QUICK REFERENCE PRODUCT INDEX

PART #:	PAGE					
TP221SFC.....60	TP316SPC.....57	TP505SFC.....58	TP602SBC.....58	TRM33M.....5	TRS9/3.....168	
TP221SFC.....60	TP317SFC.....57	TP505SFC.....58	TP602SFC.....58	TRM69M.....5	TRS9/6-316.....168	
TP222SBC.....60	TP317SPC.....57	TP506SFC.....58	TP603SBC.....58	TRM75M.....5	TRS9/6B.....168	
TP222SFC.....59	TP318SFC.....57	TP506SFC.....58	TP603SFC.....58	TRM85M.....5	TRS9/6BD.....168	
TP222SFC.....59	TP318SPC.....57	TP507SFC.....58	TP604SBC.....58	TRM86M.....5	TRS9/6HDG.....169	
TP224SFC.....59	TP319SFC.....57	TP507SFC.....58	TP604SFC.....58	TRM87M.....5	TRS9/6SS.....168	
TP224SFC.....59	TP319SPC.....57	TP508SFC.....58	TP605SBC.....58	TRM88M.....5	TRS910.....168	
TP225SFC.....59	TP320SPC.....57	TP508SFC.....58	TP605SFC.....58	TRM89M.....5	TRS910G.....169	
TP225SFC.....59	TP321SFC.....57	TP509SFC.....58	TP606SBC.....58	TRM92M.....5	TRS910PL.....169	
TP226SFC.....59	TP321SPC.....57	TP509SFC.....58	TP606SFC.....58	TRM98M.....5	TRS912.....168	
TP226SFC.....59	TP322SFC.....57	TP510SFC.....58	TP607SBC.....58	TRM99M.....5	TRS912SS.....168	
TP227SFC.....59	TP322SPC.....57	TP510SFC.....58	TP607SFC.....58	TRMK10321.....62	TS0-10M.....30	
TP227SFC.....59	TP323SFC.....57	TP511SFC.....58	TP608SBC.....58	TRMK1420.....62	TS106.....148	
TP228SFC.....59	TP323SPC.....57	TP511SFC.....58	TP608SFC.....58	TRMK632.....62	TS106G.....150	
TP228SFC.....59	TP324SFC.....56	TP512SFC.....58	TP609SBC.....58	TRMK832.....62	TS106SS.....149	
TP229SFC.....59	TP325SPC.....57	TP512SFC.....58	TP609SFC.....58	TRM1010.....168	TS109G.....150	
TP229SFC.....59	TP326SFC.....56	TP513SFC.....58	TP610SBC.....58	TRM1012.....168	TS109SS.....149	
TP231SFC.....59	TP326SPC.....56	TP513SFC.....58	TP610SFC.....58	TRM106.....168	TS112.....148	
TP231SFC.....59	TP327SFC.....56	TP514SFC.....58	TP611SBC.....58	TRM106BLK.....169	TS112SS.....149	
TP232SFC.....59	TP327SPC.....56	TP514SFC.....58	TP611SFC.....58	TRM106G.....169	TS115.....148	
TP232SFC.....59	TP328SFC.....56	TP515SFC.....58	TP612SBC.....58	TRM106SS.....168	TS1210D.....146	
TP233SFC.....59	TP328SPC.....56	TP515SFC.....58	TP612SFC.....58	TRM11-6.....168	TS12121SSD.....147	
TP233SFC.....59	TP329SFC.....56	TP516SFC.....58	TP613SBC.....58	TRM11/6SS.....168	TS1212D.....146	
TP235SFC.....60	TP330SFC.....57	TP516SFC.....58	TP613SFC.....58	TRM1110.....168	TS1212SSD.....147	
TP235SFC.....60	TP331SFC.....57	TP517SFC.....58	TP614SBC.....58	TRM1112.....168	TS12812D.....146	
TP236SFC.....60	TP332SFC.....59	TP517SFC.....58	TP614SFC.....58	TRM1210.....168	TS19M.....31	
TP236SFC.....60	TP332SFC.....59	TP518SFC.....58	TP615SBC.....58	TRM1310.....168	TS2110M.....31	
TP300SFC.....56	TP332SPC.....57	TP518SFC.....58	TP615SFC.....58	TRM133SS.....168	TS215M.....31	
TP300SPC.....56	TP333SFC.....57	TP519SFC.....58	TP616SBC.....58	TRM1410.....168	TS225M.....31	
TP301SFC.....56	TP333SPC.....57	TP519SFC.....58	TP616SFC.....58	TRM1510.....168	TS22B.....31	
TP301SPC.....56	TP334SFC.....57	TP520SFC.....58	TP617SBC.....58	TRM4/6.....168	TS22M.....31	
TP302SFC.....56	TP334SPC.....57	TP520SFC.....58	TP617SFC.....58	TRM5/3.....168	TS23M.....31	
TP302SPC.....56	TP335SFC.....57	TP521SFC.....58	TP618SBC.....58	TRM5/6SS.....168	TS24M.....31	
TP303SFC.....56	TP335SPC.....57	TP521SFC.....58	TP618SFC.....58	TRM6/113.....168	TS25B.....31	
TP303SPC.....56	TP336SFC.....57	TP522SFC.....58	TP619SBC.....58	TRM6/3.....168	TS27B.....31	
TP304SFC.....56	TP336SPC.....57	TP522SFC.....58	TP619SFC.....58	TRM6/3SS.....168	TS285M.....31	
TP304SPC.....56	TP337SFC.....57	TP523SFC.....58	TP623SFC.....59	TRM6/6B.....168	TS28B.....31	
TP305SFC.....56	TP337SPC.....57	TP523SFC.....58	TP623SFC.....59	TRM6/6PL.....169	TS29B.....31	
TP305SPC.....56	TP338SFC.....57	TP524SFC.....58	TP624SFC.....57	TRM6/6SS.....168	TS30B.....31	
TP306SFC.....56	TP338SPC.....57	TP524SFC.....58	TP624SFC.....58	TRM610.....168	TS312CCL.....148	
TP306SPC.....56	TP339SFC.....57	TP525SFC.....58	TP624SFC.....58	TRM610D.....168	TS312G.....150	
TP307SFC.....56	TP340SFC.....57	TP525SFC.....58	TP625SFC.....57	TRM612SS.....168	TS32180SS.....149	
TP307SPC.....56	TP341SFC.....57	TP526SFC.....58	TP625SFC.....58	TRM7/3.....168	TS3312.....148	
TP308SFC.....56	TP342SFC.....57	TP526SFC.....58	TP625SFC.....58	TRM7/3SS.....168	TS33120SS.....149	
TP308SPC.....56	TP344SFC.....57	TP527SFC.....58	TP701SFC.....56	TRM7/6.....168	TS33121SSD.....147	
TP309SFC.....56	TP346SFC.....57	TP527SFC.....58	TP702SPC.....57	TRM7/6SS.....168	TS3312D.....146	
TP309SPC.....56	TP350SFC.....57	TP528SFC.....58	TP707SFC.....59	TRM710.....168	TS3312SS.....149	
TP310SFC.....56	TP351SPC.....57	TP528SFC.....58	TP707SFC.....59	TRM8-6BLK.....169	TS3410D.....146	
TP310SPC.....56	TP352SPC.....57	TP529SFC.....58	TP708SFC.....59	TRM8/3.....168	TS3410SSD.....147	
TP311SFC.....56	TP353SFC.....56	TP529SFC.....58	TP708SFC.....59	TRM8/6-316.....168	TS3412D.....146	
TP311SPC.....56	TP500SFC.....58	TP530SFC.....58	TPK30.....60	TRM8/6B.....168	TS3412SSD.....147	
TP312SFC.....57	TP500SFC.....58	TP530SFC.....58	TRM100M.....5	TRM8/6D.....168	TS34512G.....150	
TP312SPC.....57	TP501SFC.....58	TP531SFC.....58	TRM101M.....5	TRM8/6HDG.....169	TS347D.....146	
TP313SFC.....57	TP501SFC.....58	TP531SFC.....58	TRM102M.....5	TRM8/6SS.....168	TS34812D.....146	
TP313SPC.....57	TP502SFC.....58	TP532SFC.....58	TRM103M.....5	TRM810.....168	TS34851SSD.....148	
TP314SFC.....57	TP502SFC.....58	TP532SFC.....58	TRM104M.....5	TRM810A.....168	TS3485SSD.....147	
TP314SPC.....57	TP503SFC.....58	TP600SBC.....58	TRM113M.....5	TRM810HDG.....169	TS34B.....32	
TP315SFC.....57	TP503SFC.....58	TP600SFC.....58	TRM16M.....5	TRM812.....168	TS3612.....148	
TP315SPC.....57	TP504SFC.....58	TP601SBC.....58	TRM20M.....5	TRM812SS.....168	TS385.....148	
TP316SFC.....57	TP504SFC.....58	TP601SFC.....58	TRM22M.....5	TRM87.....168	TS3850SS.....149	

When Searching Stock # Drop "J"

[www.metallics.us](http://www.metallics.us)

PART #:	PAGE										
TS3851SSD.....	147	TS5810SSD.....	147	TSP14M.....	30	TXW10112.....	45	UBG015.....	125	WAK1425QDB.....	157
TS385D.....	146	TS58121SSD.....	147	TSP15M.....	30	TXW1034.....	45	UBG018.....	125	WAK14B.....	157
TS385G.....	150	TS5812D.....	146	TSP17M.....	30	TXW121.....	45	UBG021.....	125	WAK14D.....	155
TS385SSD.....	146	TS5812SSD.....	147	TSP18M.....	30	TXW12112.....	45	UBG022.....	125	WAK14DB.....	157
TS3871SSD.....	147	TS587.....	147	TSP19M.....	30	TXW12114.....	45	UBG023.....	125	WAK14H.....	155
TS387D.....	146	TS5871SSD.....	147	TSP28M.....	30	TXW122.....	45	UBS01.....	124	WAK14HB.....	157
TS387SSD.....	146	TS59B.....	32	TSP29M.....	30	TXW1224112.....	46	UBS010.....	125	WAK14HBSS.....	157
TS407.....	148	TS6070SS.....	150	TSP67B.....	30	TXW1224114.....	46	UBS011.....	125	WAK14HSS.....	156
TS4070SS.....	149	TS6071SSD.....	148	TSP68V.....	30	TXW123.....	45	UBS012.....	125	WAK14Q.....	155
TS407D.....	146	TS6075SSD.....	147	TSP70B.....	30	TXW1234.....	45	UBS013.....	125	WAK14QB.....	157
TS407G.....	150	TS60B.....	32	TSP80M.....	30	TXW1234.....	46	UBS014.....	125	WAK14QD.....	156
TS4085G.....	150	TS610.....	148	TSP81M.....	30	TXW1278.....	46	UBS015.....	125	WAK14QD145.....	156
TS4085SS.....	149	TS610G.....	150	TSP82M.....	30	TXW141.....	46	UBS016.....	125	WAK14QDB.....	157
TS4234M.....	148	TS610SS.....	149	TSP83M.....	30	TXW141.....	46	UBS017.....	125	WAK14R.....	155
TS4334C.....	148	TS612.....	148	TSP84M.....	30	TXW14112.....	46	UBS018.....	125	WAK14RB.....	157
TS4414C.....	148	TS612SS.....	149	TSP85B.....	30	TXW14114.....	46	UBS020.....	125	WAK14SS.....	156
TS45120SS.....	149	TS61B.....	32	TSSK8.....	64	TXW142.....	46	UBS021.....	125	WAK14SSPH.....	156
TS45121SSD.....	147	TS62B.....	32	TTS21-5M.....	27	TXW1434.....	46	UBS022.....	125	WAK14T.....	155
TS4512D.....	146	TS63B.....	32	TTS31B.....	28	TXW1478.....	46	UBS023.....	125	WAK14TB.....	157
TS4512SSD.....	147	TS64340SS.....	150	TTS33B.....	28	TXW1478.....	46	UBS024.....	125	WAK14V.....	154
TS4812.....	148	TS6512.....	148	TTSK10.....	64	TXW1478.....	46	UBS025.....	125	WAK15.....	156
TS48121SSD.....	147	TS65120SS.....	150	TTSK8.....	64			UBS03.....	124	WAK15114HB.....	158
TS4812SSD.....	147	TS65121SSD.....	147	TWH1.....	217			UBS04.....	124	WAK15B.....	158
TS505.....	148	TS6512SS.....	149	TWH2.....	217			UBS05.....	125	WAK15CB.....	158
TS5050SS.....	149	TS6512SSD.....	147	TX103HL17.....	46			UBS06.....	125	WAK15D.....	156
TS5051SSD.....	147	TS65B.....	30	TX12114SS.....	46			UBS07.....	125	WAK15QD.....	156
TS505D.....	146	TS66.....	30	TX12114SSB.....	46			UBS08.....	125	WAK15QDB.....	158
TS505G.....	150	TS66140SS.....	150	TX121SS.....	46			UBS09.....	125	WAK15R.....	156
TS505SS.....	149	TS66141SSD.....	148	TX1234.....	46			UBS38212.....	125	WAK15RB.....	158
TS505SSD.....	147	TS6614SS.....	149	TX1478.....	46			UBS516134.....	125	WAK15S.....	156
TS506.....	148	TS6614SSD.....	147	TX1478M.....	46			UBS516138.....	125	WAK15SB.....	157
TS5060SS.....	149	TS66181SSD.....	147	TXV101Z.....	45			US6.....	213	WAK16.....	155
TS5061SSD.....	147	TS6618G.....	150	TXV12112.....	45					WAK16B.....	157
TS506D.....	146	TS6618SSD.....	147	TXV12112D.....	45					WAK16H.....	155
TS506G.....	150	TS66M.....	30	TXV12112VLB.....	45					WAK16QD.....	155
TS506SS.....	149	TS6701.....	148	TXV12114.....	45					WAK16R.....	155
TS506SSD.....	147	TS6701D.....	146	TXV12114B.....	45					WAK16T.....	155
TS507.....	148	TS6712D.....	146	TXV12114D.....	45					WAK18.....	158
TS5070SS.....	149	TS671D.....	146	TXV12114VLB.....	45					WAK18T.....	158
TS507D.....	146	TS6812.....	148	TXV12114Z.....	45					WAK19.....	158
TS507G.....	150	TS6812G.....	150	TXV12114ZVLB.....	45					WAK191S.....	159
TS507SS.....	149	TS6812SS.....	149	TXV12200.....	45					WAK1925QD.....	159
TS508.....	148	TS7810.....	148	TXV12200D.....	45					WAK19B.....	157
TS5080SS.....	149	TS7810D.....	146	TXV12200VLB.....	45					WAK19H.....	158
TS5081SSD.....	147	TS786.....	148	TXV123.....	45					WAK19QD.....	159
TS508D.....	146	TS786D.....	146	TXV123Z.....	45					WAK19S.....	158
TS508G.....	150	TS786SS.....	149	TXV1278.....	45					WAK19SS.....	158
TS508SS.....	149	TS788.....	148	TXV1278D.....	45					WAK19T.....	158
TS508SSD.....	147	TS788D.....	146	TXV14112.....	45					WAK2.....	155
TS510.....	148	TS788G.....	150	TXV143.....	45					WAK20.....	158
TS510SS.....	149	TS81M.....	31	TXV143D.....	45					WAK22.....	160
TS512.....	148	TS99.....	30	TXV144.....	45					WAK23.....	160
TS512SS.....	149	TSF21V.....	25	TXV14400.....	45					WAK23F.....	160
TS5164.....	148	TSF22M.....	25	TXV14400VLB.....	45					WAK23QD.....	160
TS5234.....	148	TSF24M.....	25	TXV144D.....	45					WAK23T.....	160
TS5412SSD.....	147	TSF26M.....	25	TXV145.....	45					WAK24.....	160
TS55B.....	32	TSK10.....	67	TXV145D.....	45					WAK25.....	160
TS57B.....	32	TSK10SS.....	63	TXV146D.....	45					WAK33.....	160
TS58101SSD.....	147	TSK8.....	67	TXV148.....	45					WAK33R.....	160
TS5810D.....	146	TSP10M.....	30	TXV148D.....	45					WAK34.....	160

## U

UAK1.....	133
UAK2.....	133
UAK3.....	133
UAK4.....	133
UB01.....	124
UB010.....	124
UB011.....	124
UB012.....	124
UB013.....	124
UB014.....	124
UB015.....	124
UB015PL.....	124
UB016.....	124
UB017.....	124
UB018.....	124
UB019.....	124
UB021.....	124
UB021PL.....	124
UB022.....	124
UB023.....	124
UB023PL.....	124
UB024.....	124
UB024PL.....	124
UB025.....	124
UB026.....	124
UB026PL.....	124
UB03.....	124
UB04.....	124
UB045.....	124
UB05.....	124
UB06.....	124
UB07.....	124
UB08.....	124
UB09.....	124
UBG010.....	125
UBG014.....	125

## W

W1135M.....	85
W114B.....	85
W114M.....	85
W1165M.....	85
W116B.....	85
W116M.....	85
W116V.....	85
W117B.....	85
W117M.....	85
W119B.....	85
W119M.....	85
W119V.....	85
W120M.....	86
W122M.....	85
W123M.....	85
W127M.....	85
WAK13.....	155
WAK13B.....	157
WAK13BV.....	157
WAK14.....	155
WAK141.....	156
WAK1415H.....	156
WAK141B.....	157
WAK141H.....	156
WAK141QDB.....	157



# QUICK REFERENCE PRODUCT INDEX

PART #:	PAGE		
WAK7	159	WAKJ2	155
WAK8	159	WAKJ20	158
WAK8qd	159	WAKJ22	160
WAK8T	159	WAKJ23	160
WAK9	159	WAKJ23F	160
WAKJ13	155	WAKJ23QD	160
WAKJ13B	157	WAKJ23T	160
WAKJ14	155	WAKJ24	160
WAKJ141	156	WAKJ25	160
WAKJ1415H	156	WAKJ33	160
WAKJ141B	157	WAKJ33R	160
WAKJ141H	156	WAKJ34	160
WAKJ141QDB	157	WAKJ7	159
WAKJ1425QDB	157	WAKJ8	159
WAKJ14B	157	WAKJ8qd	159
WAKJ14D	155	WAKJ8T	159
WAKJ14DB	157	WAKJ9	159
WAKJ14H	155	WAKQUAD	161
WAKJ14HB	157	WAKTRIO	154
WAKJ14HBSS	157	WDS15B	54
WAKJ14HSS	156	WDS1B	54
WAKJ14Q	155	WDS1M	54
WAKJ14QB	157	WDS2B	54
WAKJ14QD	156	WDS2M	54
WAKJ14QD145	156	WDS3B	54
WAKJ14QDB	157	WDS3M	54
WAKJ14R	155	WDS45B	54
WAKJ14RB	157	WDS4B	54
WAKJ14SS	156	WDS4M	54
WAKJ14SSPH	156	WDS6M	54
WAKJ14T	155	WDW1B	53
WAKJ14TB	157	WDW1M	53
WAKJ15	156	WDW2B	53
WAKJ15114HB	158	WDW2M	53
WAKJ15B	158	WDW3B	53
WAKJ15CB	158	WDW3M	53
WAKJ15D	156	WDW45B	53
WAKJ15QD	156	WDW4B	53
WAKJ15QDB	158	WDW4M	53
WAKJ15R	156	WGC100	191
WAKJ15RB	158	WGD100	191
WAKJ15S	156	WGD25	191
WAKJ15SB	157	WGR100	191
WAKJ16	155	WGR25	191
WAKJ16B	157	WGT100	191
WAKJ16H	155	WGT25	191
WAKJ16QD	155	WSK10	66
WAKJ16R	155	WSK10CD1	66
WAKJ16T	155	WW80B	82
WAKJ18	158	WW82B	82
WAKJ18T	158	WW82M	82
WAKJ19	158	WW832M	82
WAKJ191S	159	WW83M	82
WAKJ1925QD	159	WW85M	82
WAKJ19B	157		
WAKJ19H	158	<b>Z</b>	
WAKJ19QD	159	ZSA1B/box	163
WAKJ19S	158	ZSA1J/jar	163
WAKJ19SS	158	ZSA1K/box	163
WAKJ19T	158		
		ZSA1M/box	163
		ZSA1TJ/jar	163
		ZSA1TK/box	163
		ZSAL2J/jar	163
		ZSAL2K/box	163
		ZSTU1J/jar	162
		ZSTU1K/kit	162
		ZSTU1M/box	162



# METALLICS

Visit us online at  
[www.metallics.us](http://www.metallics.us)

