

BODY
TK201B

BUSHING
TK-201-SRB

NUT
TK-201-N

O-RING
SOR-1-VNT

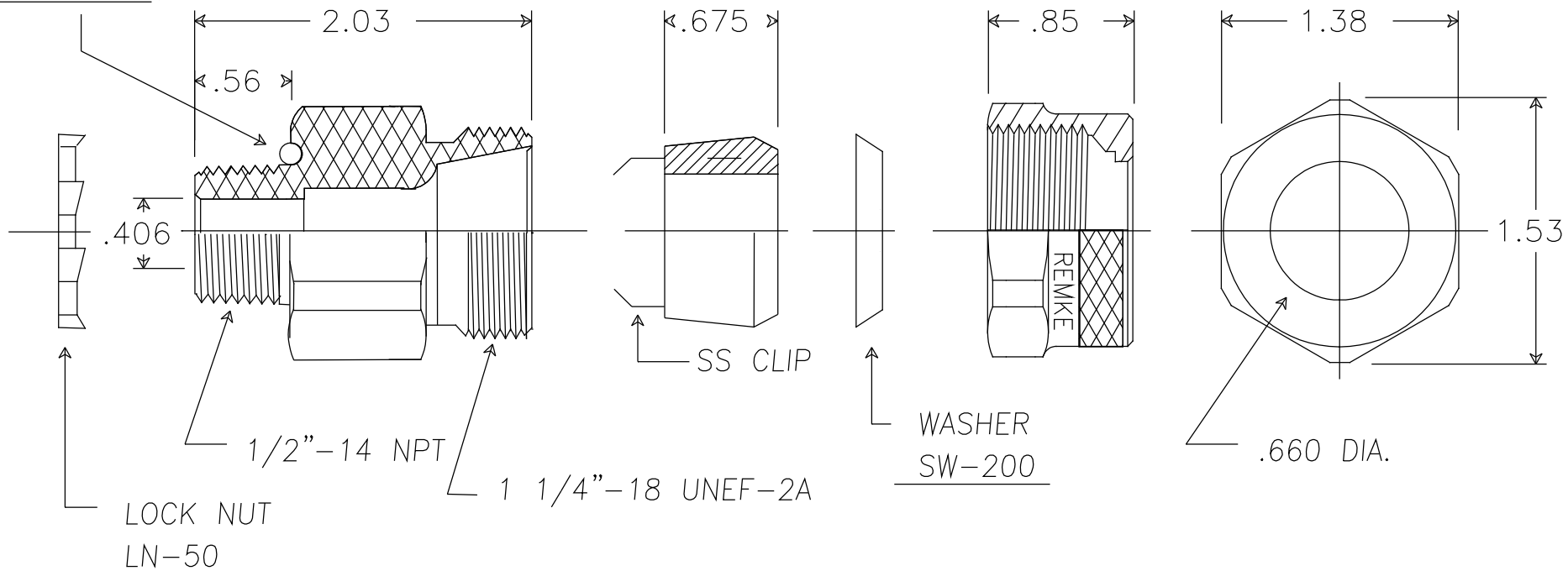

MATERIAL:

ALUMINUM BODY AND NUT
NEOPRENE RUBBER BUSHING & SS CLIPS
NEOPRENE RUBBER O-RING
ZINC PLATED STEEL WASHER

REV.	DATE	CHANGE

UNLESS OTHERWISE SPECIFIED
3-PLC. DIM. +/-.005
2-PLC. DIM. +/-.010
1-PLC. DIM. +/-.015
FRACTIONAL +/-.1/64
ANGULAR +/°1

REMKE INDUSTRIES

Wheeling, Illinois 60090

SCALE: APPROX FULL
MATERIAL: SEE NOTE
FINISH: NICKEL
PART NAME: MC CABLE CONNECTOR
PART NUMBER: RTKN-050-1L
DRAWING DATE: 4/19/10