

RCAD570

Dual Stud Articulating TV Mount

kanto
INSTALLER SERIES

NO ONLINE SALES

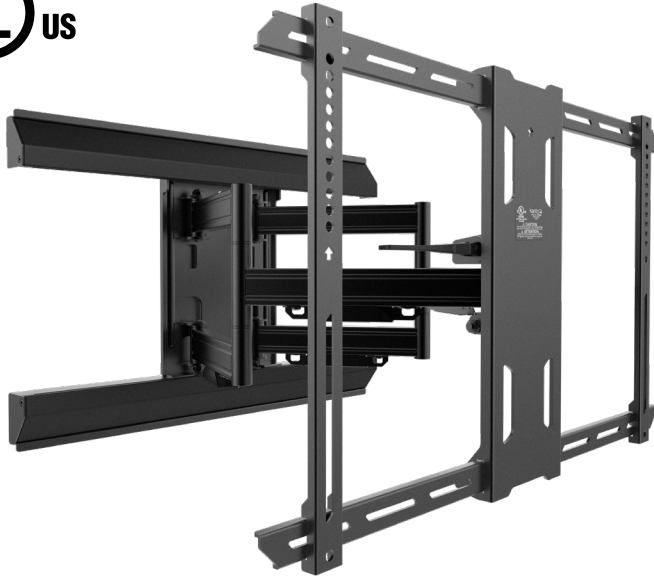

UP TO 125 LB



39"–83"



600 x 400



2.5" PROFILE
22" EXTENSION



+12° TO
-3° TILT



16" STUD
SUPPORT



6" HORIZONTAL
OFFSET



PERFECT PLACEMENT

With the ability to offset the articulating arm independently of the wall plate, you'll be able to position your clients' TV perfectly on the wall regardless of stud layout.



UNIVERSALLY COMPATIBLE

Boasting an impressive 125 lb weight capacity and support for VESA patterns up to 600x400, RCAD570 full motion mount is suitable for nearly any TV on the market.



FULLY ADJUSTABLE

RCAD570 TV wall mount has a tool-less cam lever tilt mechanism, and articulating arms that can swivel up to 90° in either direction. Post-installation horizontal leveling lets you dial in your clients' TV perfectly.



PLENTIFUL EXTENSION

Even with its low-profile design, RCAD570 articulating TV mount can extend 22" from the wall, giving you plenty of room to work behind the TV and allow your customer to position their TV wherever they'd like.



MADE FOR PROFESSIONALS

The RCAD570 full motion TV mount comes with sleek aluminum magnetic wall plate covers to hide any sign of installation, and a durable all-metal cable management system intended to last for years and prevents service calls.

Features and Specifications

- Fits most TVs from 39" to 83"
- Supports TVs up to 125 lb (57 kg)
- Accommodates VESA sizes from 200x100 to 600x400
- 6" (15.2 cm) of adjustable horizontal offset from center position
- Tool-less tilt mechanism provides a +12° to -3° tilt angle
- 90° of swivel in either direction, depending on screen size
- Sits 2.5" (6.3 cm) and extends up to 22" (55.9 cm) from the wall
- Integrated all-metal cable management
- Adjustable horizontal leveling
- 23.2" (59 cm) wall plate accommodates up to 16" stud spacing
- Solid steel construction with durable powder coated finish
- Includes manual and all mounting hardware for wood stud and concrete installation
- UL listed
- Ten year warranty
- Shipping box weight: 34.8 lb (15.8 kg)
- Shipping Box Dimensions: 29.4" x 18" x 4.2" (74.7 x 45.7 x 10.6 cm)
- Product Weight: 29 lb (13.2 kg)
- UPC: 800152721200

DIMENSIONS

