

FEATURES:

1. Material: Tin Plated Aluminum
2. UL listed for U.S. & Canada.
3. Wire connector rated for 35Kv max.
4. Class B/C compressed, concentric, and compact conductor.
5. Dual rated AL9CU.
6. Supplied with EPDM insulated cover.
7. Connector is pre-filled with oxide inhibitor.
8. Dimensions are for reference only.

PTO Series: PTO-750



PROGRAM:	SOLIDWORKS
UPDATED:	4/2022
SALES REV:	A
SIZE:	B (11x17)

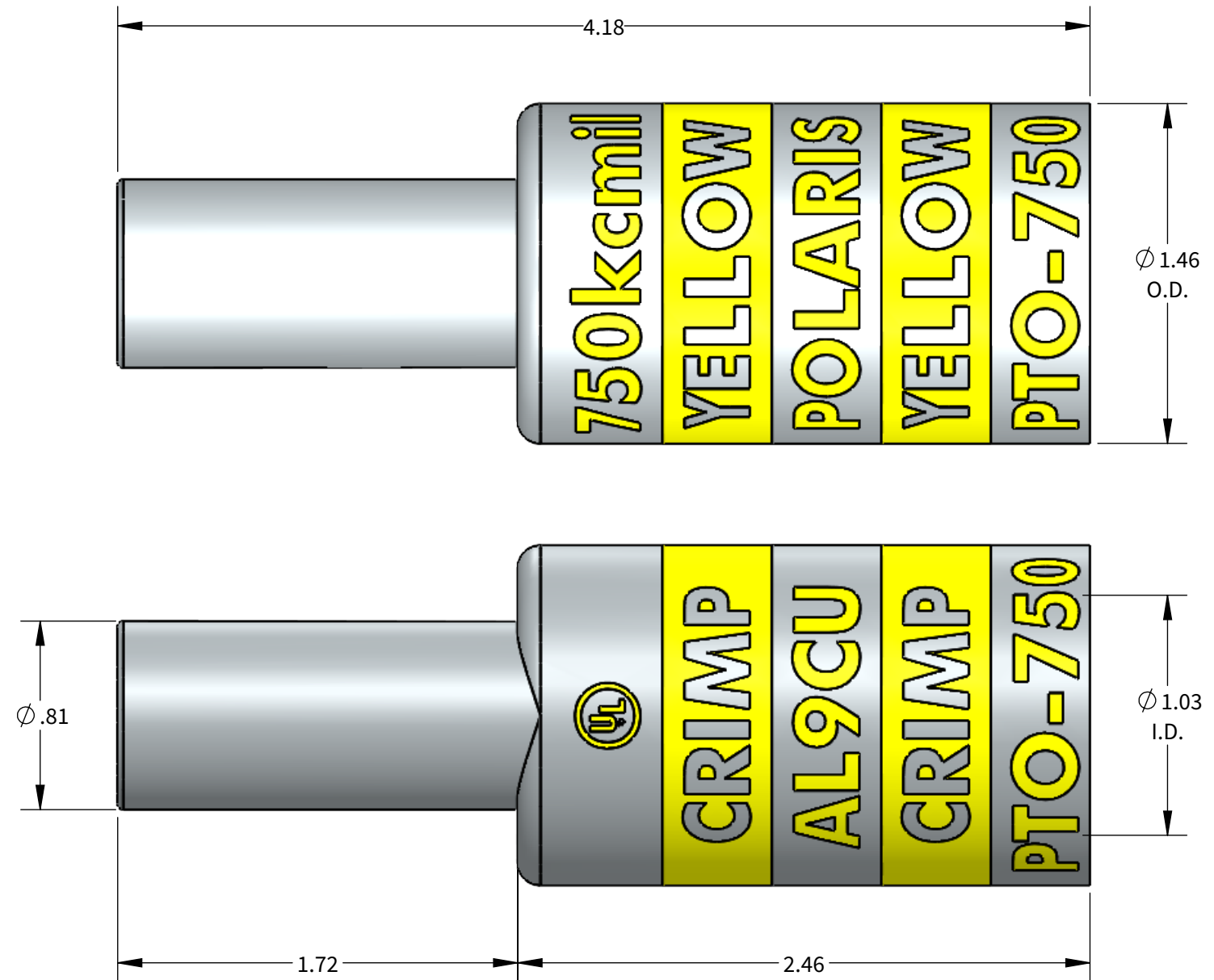
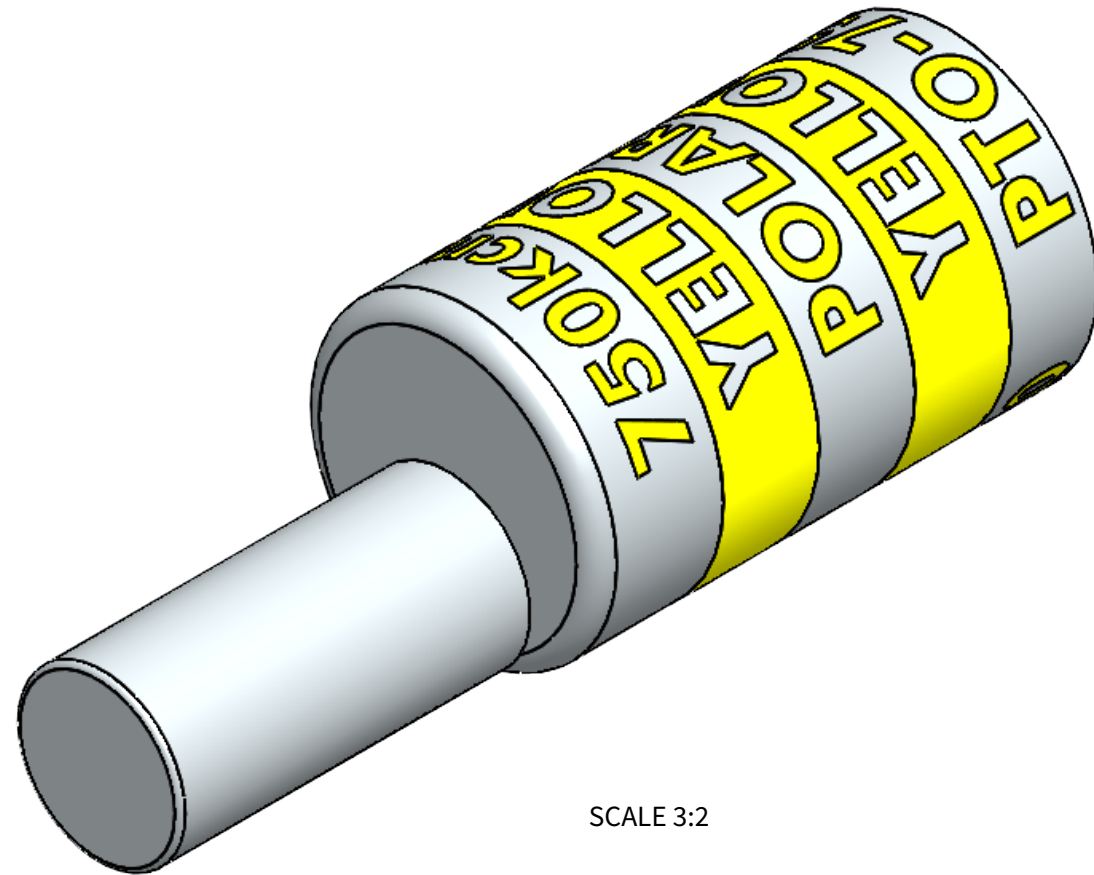

ALUMINUM COMPRESSION CONNECTOR TOOL AND DIE CHART
(# OF CRIMPS)

			GREENLEE
WIRE SIZE	STRIP LENGTH	DIE COLOR	N1240 SERIES
750kcmil	1-7/8"	YELLOW	CD23(2)

