

FEATURES:

1. Material: Tin Plated Aluminum
2. UL listed for U.S. & Canada.
3. Wire connector rated for 35Kv max.
4. Class B/C compressed, concentric, and compact conductor.
5. Dual rated AL9CU.
6. Expanded wire range when installed with dieless NSi compression tool (N12ID).
7. Dimensions are for reference only, tolerance is +/- .06".V

AL Series: AL2/0-48



PROGRAM:	SOLIDWORKS
UPDATED:	4/2022
SALES REV:	A
SIZE:	B (11x17)

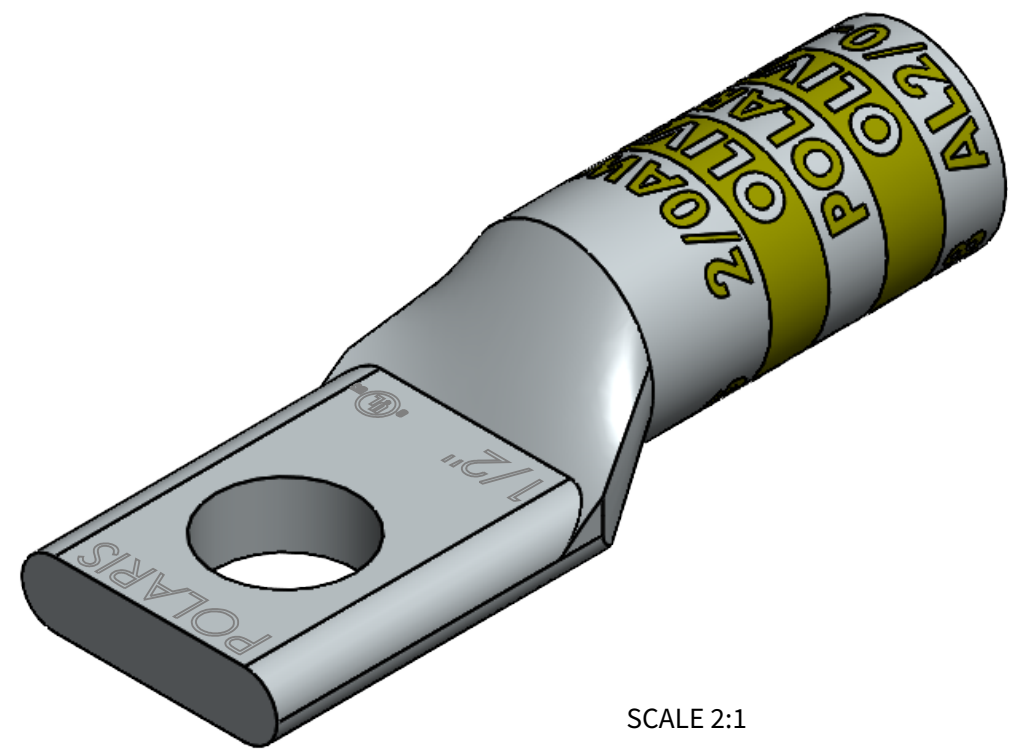

SCALE 2:1

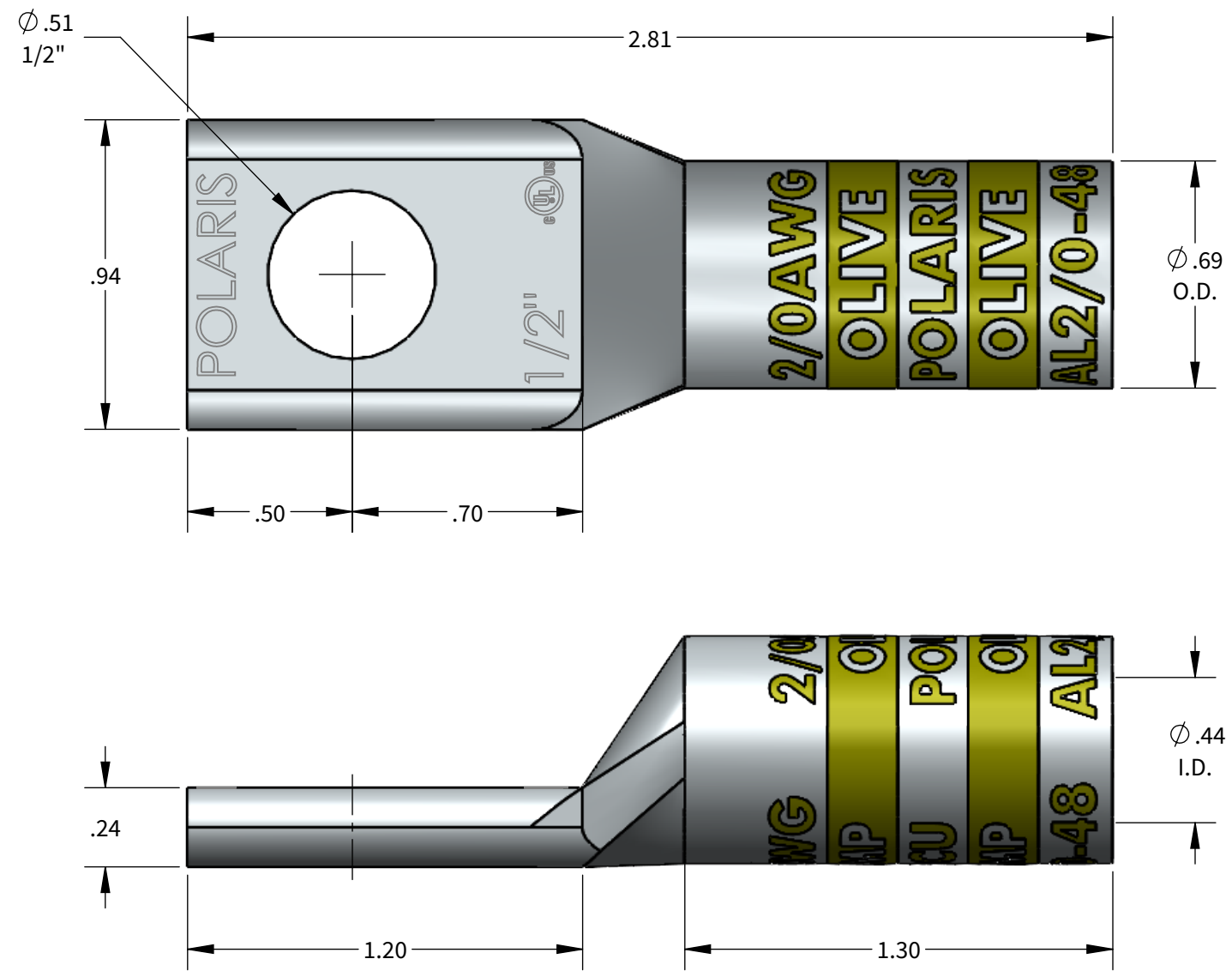

ALUMINUM COMPRESSION CONNECTOR TOOL AND DIE CHART (# OF CRIMPS)

WIRE SIZE	STRIP LENGTH	DIE COLOR	ALUMINUM COMPRESSION CONNECTOR TOOL AND DIE CHART (# OF CRIMPS)			
			NSI	GREENLEE	BURNDY	
			EXPANDED WIRE RANGE W/ N12ID	N1240 SERIES	1240 SERIES	Y-35, Y750, PAT 750
2/0AWG	1-3/8"	OLIVE	2/0AWG-#4AWG	KA12-2/0 (2)	KA12-2/0 (2)	U26ART (2)