

JOB NAME:

DATE:

TYPE:

COMMENTS:

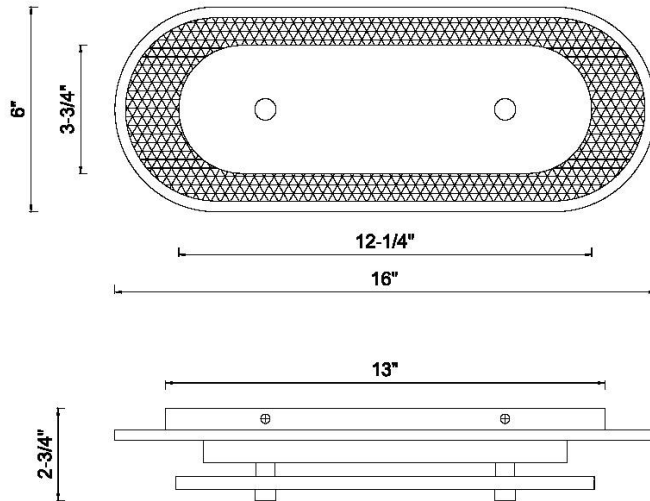

LIGHT INFORMATION

Light Type	Integrated LED
CRI	90
Delivered Lumens	492
Color Temperature	3000K
LED Lifespan (L70)	52000
Light Direction	Ambient
Dimming Method	Triac/Elv
Current Type	AC
Input Voltage	120
Total Wattage	12

DIMENSIONS & WEIGHT

Width (In)	16
Height (In)	6
Ext (In)	2.75
Weight (Lbs)	5.07

INSTALLATION

Mounting Type	J-Box
Rating	Damp
Hanging Support Type	J-Box

PRODUCT FINISH

Matte Black

SHADE FINISH

Alabaster

PRODUCT FEATURES

This product is crafted from natural stone; inherent variations in color, pattern, and texture are to be expected.

CERTIFICATIONS & COMPLIANCE

