

POLARIS®

NMS-2 SERIES

For splicing and tapping non-metallic (NM) cable.

GENERAL INFORMATION:

- For use on 12 or 14 AWG (300v) 2 Wire NM cable with ground.
- Eliminates junction boxes
- Contents complete one splice
- Fast and simple to install

ASSEMBLY INSTRUCTIONS:

See figures 1-5 for assembly procedure.

1. Cut and strip outer cable jacket to match the markings indicated on the connector housing (Fig.1)
 2. Align wires with markings on the housing. Place the wires on the contacts. Do not push the wires into slots. Wire ends must extend .250 in. (6.35mm) min. (Fig.2)
 3. Hold wires in place and cover firmly. Place slip-joint pliers so the jaw flats are parallel and press evenly to close. (Fig.3)
 4. Grip the housing and cover firmly. Place slip-joint pliers so that jaw flats are parallel and press evenly to close. Squeeze the slip-joint pliers handles until the two pieces snap into place. (Fig.4)
 5. Slide the splices into each other until the locking latches engage the locking tabs. (Fig.5)
6. Coupled splices can be mounted to a stud or joist with four 4d common nails.

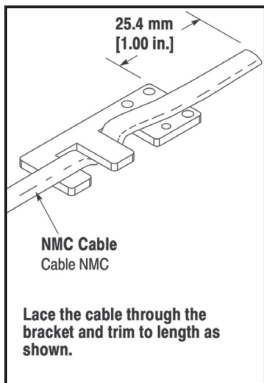
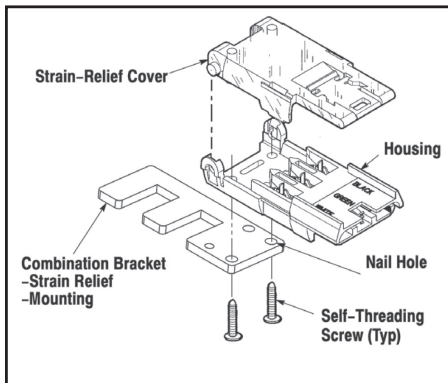

ATTENTION: Improperly installed electrical wiring can be dangerous and cause electrical fires. Consult local building code before doing any electrical work. Do not re-terminate a splice if wire was previously used. Keep out of the reach of children. Safety First!

Figure 1

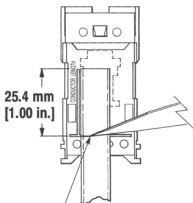

Ground Wire (Green Cor
Position on Housing)

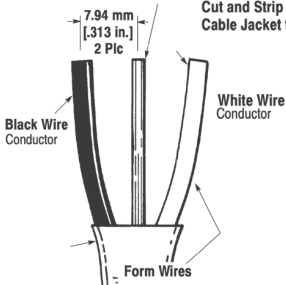

Cut and Strip Outer
Cable Jacket to Marking

Figure 2

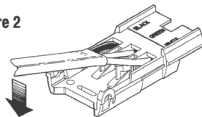

Figure 3

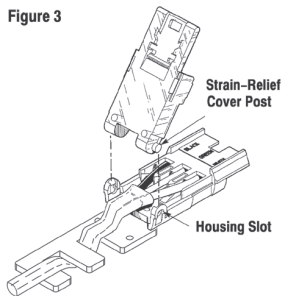
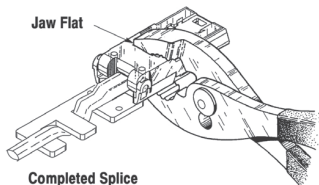
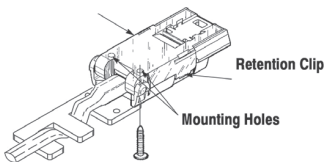

Figure 4

Jaw Flat



Completed Splice



Retention Clip

Mounting Holes

Figure 5

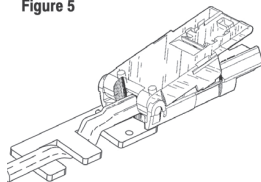

Locking Tab

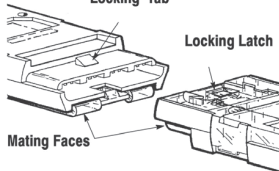

Locking Latch

Mating Faces

