

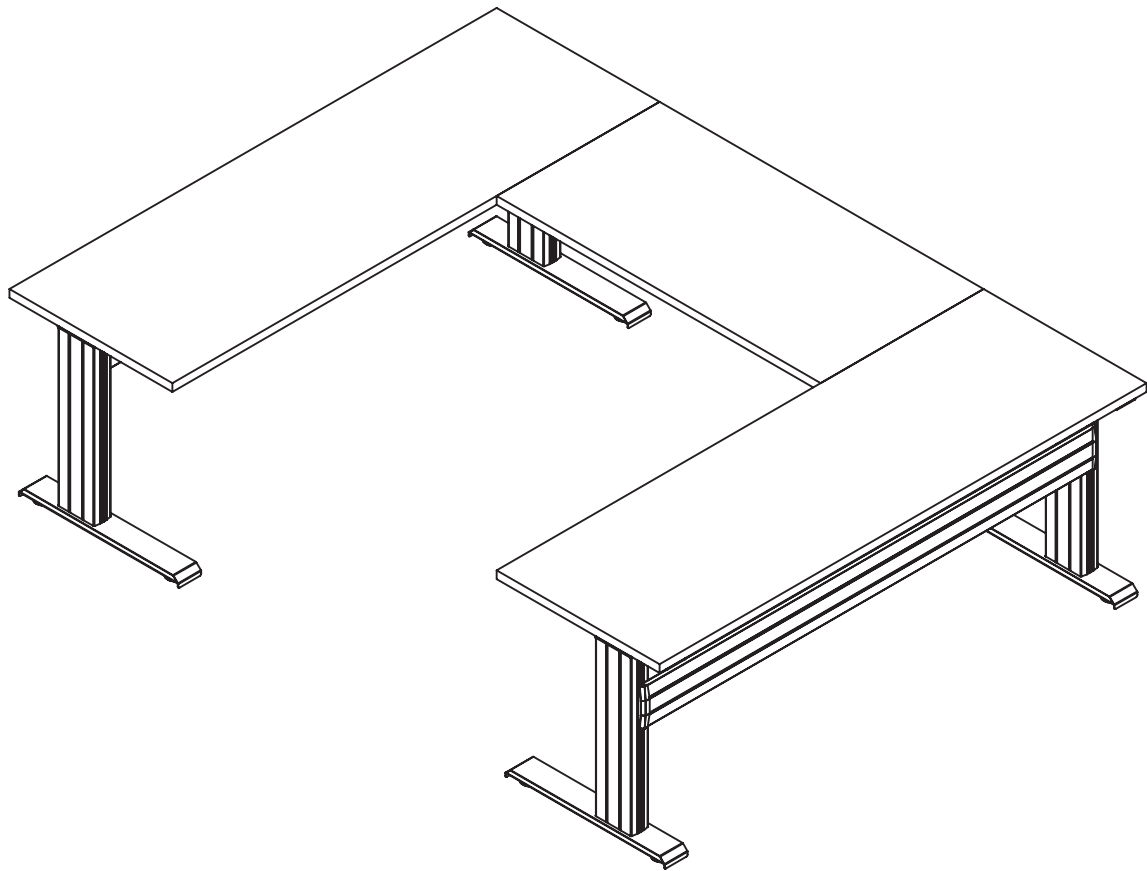

**NewHeights™ Series 4 Eficiente LT U-Shape
Supplemental Instruction
Warranty: raproducts.com/warranty**



READ ALL INSTRUCTIONS BEFORE USING THIS PRODUCT.



**USE THIS PRODUCT ONLY AS INSTRUCTED.
FAILURE TO COMPLY WITH ALL INSTRUCTIONS AND WARNINGS
MAY RESULT IN SERIOUS PROPERTY DAMAGE OR BODILY INJURY.**

Basic Safety Instructions

1. **Intended Use.** This Product is exclusively designed for use as indoor office furniture in compliance with all instructions and safety warnings in the user manual. Any different use, or use extending beyond the intended use, may result in property damage or bodily injury and is prohibited. This Product should not be used, operated or maintained with additional components not authorized by K&A Manufacturing, Inc.

BY USING THIS PRODUCT OR ANY FEATURE OF THIS PRODUCT, YOU AGREE TO COMPLY WITH ALL PRODUCT TERMS AND POLICIES, INCLUDING WITHOUT LIMITATION ANY SAFETY WARNINGS AND INSTRUCTIONS, PROVIDED BY K&A MANUFACTURING, INC. AND ITS AFFILIATES. K&A MANUFACTURING, INC. SHALL ASSUME NO LIABILITY FOR ANY DAMAGE OR INJURY CAUSED BY USE OF THE PRODUCT A) IN VIOLATION OF ANY SAFETY WARNINGS OR INSTRUCTIONS; B) NOT AUTHORIZED BY K&A MANUFACTURING, INC.; OR C) BY EVENTS BEYOND K&A MANUFACTURING, INC.'S CONTROL.



**DO NOT SIT, STAND OR CRAWL ON OR UNDER THE PRODUCT.
MAKE SURE NO OBSTACLES ARE IN THE PRODUCT'S PATH.
MAKE SURE ALL CORDS ARE LONG ENOUGH TO ACCOMMODATE ANY CHANGE IN HEIGHT.
DO NOT USE ATTACHMENTS NOT RECOMMENDED BY THE MANUFACTURER.**

2. **Electrical Height Adjustment.** The height of this Product may be adjusted electronically. Contact with electrical voltage may cause serious injury and death. Only use the Product in compliance with these instructions. This Product should not be used in environments with high levels of humidity or moisture.

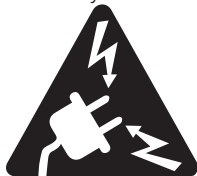

**KEEP CORDS AND ELECTRICAL COMPONENTS AWAY FROM HEAT AND LIQUIDS.
DO NOT OPEN ANY OF THE COMPONENTS: CONTROL BOX OR KEYPAD.
DO NOT USE WITH A DAMAGED PLUG OR CORD.
DO NOT INSERT ANYTHING INTO ANY SEAM OR OPENING.**

3. **Setup and Use.** This Product should only be used and operated in good condition. When in use, no one should sit, stand or crawl on or under the Product. There is a danger of crushing, shearing, injury or damage. Keep the entire range of motion of the Product clear of all obstacles. Devices and object on the Product can tip over, fall or be crushed by the Product.



**KEEP HANDS AND FINGERS CLEAR.
KEEP ALL OBSTACLES CLEAR OF THE PRODUCT'S PATH.**

4. **Users.** This Product is not intended for use with children, individuals with restricted physical, sensory or mental capabilities, or individuals who lack experience or knowledge, unless they are supervised by a person who is responsible for their safety or they have received instructions from a person who is responsible for their safety concerning how the Product must be used. Children should be closely supervised to ensure that they do not play with the Product and its height adjustment mechanism to avoid risk of physical injury or electric shock.



KEEP CHILDREN AWAY FROM THE PRODUCT, ITS CONTROL UNITS, AND KEYPADS.

Tools Required for Assembly

- A. Power Driver with Adjustable Torque
- B. #2 Square Head Drive Bit (**Recommended**)
- C. #2 Phillips Head Driver Bit

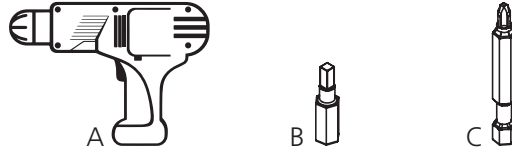

Hardware Included for Assembly (may have extra)

- D. 10 x 5/8" Round Washer Head Screw x16
- E. 35UP Joiner Plate x4
- F. 8 x 3/4" Pan Head Phillips/Square Drive Screw x4

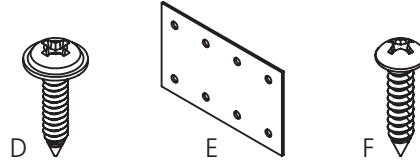

Parts

- G. U-Channel x2
- H. Control Box x1
- I. Wire Clips x4
- J. Plastic Wire Management x2
- K1. Two Button Up/Down Switch x1
- K2. Four Button Programmable Up/Down Switch
Optional - *If you have a programmable switch, please refer to the installation instructions included with the switch.*

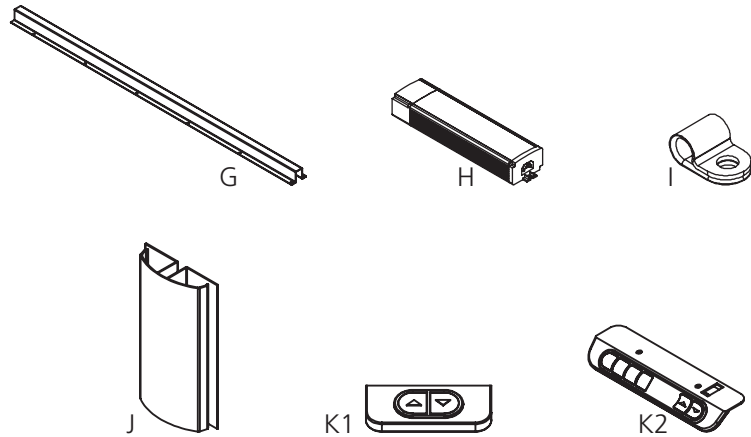

Step 1

- Assemble the side sections of the workstations using instruction #53026.
- While the side sections are still upside down, attach four 35UP (E) joiner plates centered on the edges of the worksurfaces at 3" and 18" from the back of the worksurfaces.
- With a low torque setting on the power driver, attach each plate with four wood screws. **Do not over-tighten the screws.**
- With the help of an assistant, set the side sections upright in their final location.
- Level according to instruction #53026.

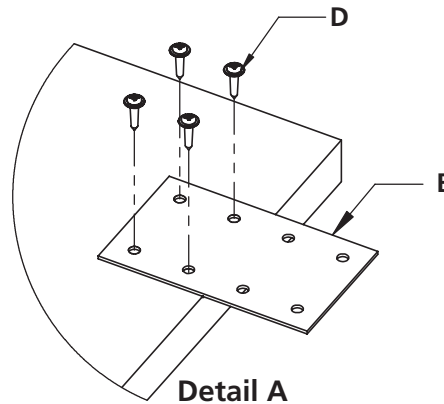
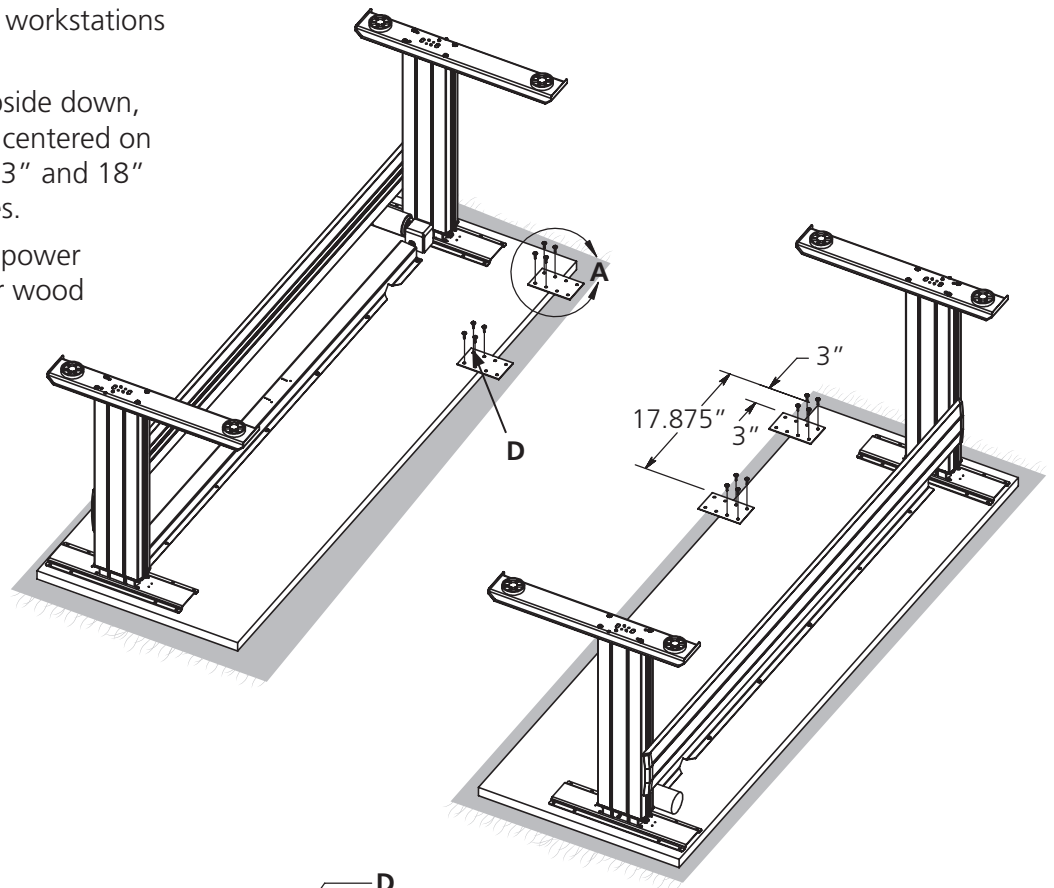
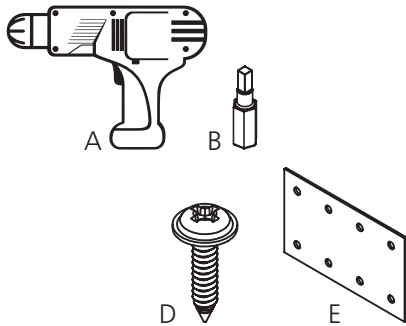

Step 2

- Place the center worksurface between the side sections of the unit.
- Rest the worksurface on the joiner plates 35UP (E), tight to the side section worksurface and flush with the back.
- Attach the worksurface with four wood screws in each joiner plate.
- Center the U-Channel on the center worksurface and attach it with wood screws.

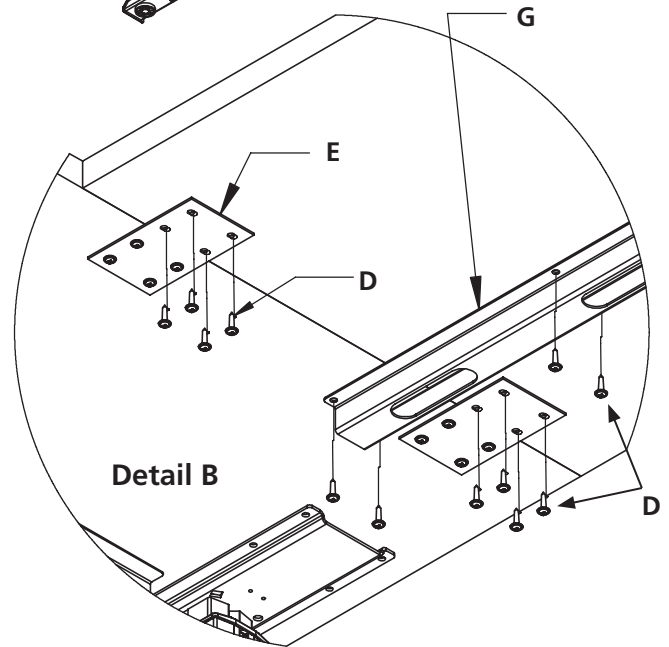
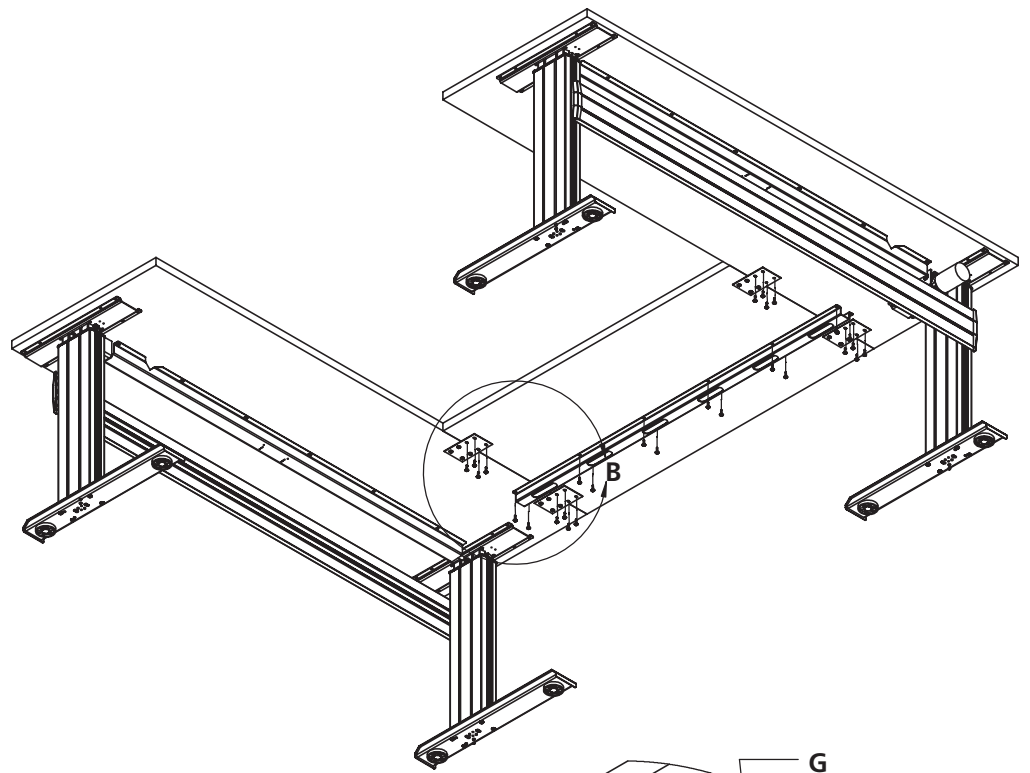
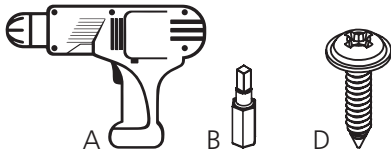

Step 3 - Cable Routing Diagram

- Install control box, switch, wire clips, and plastic wire management as shown.

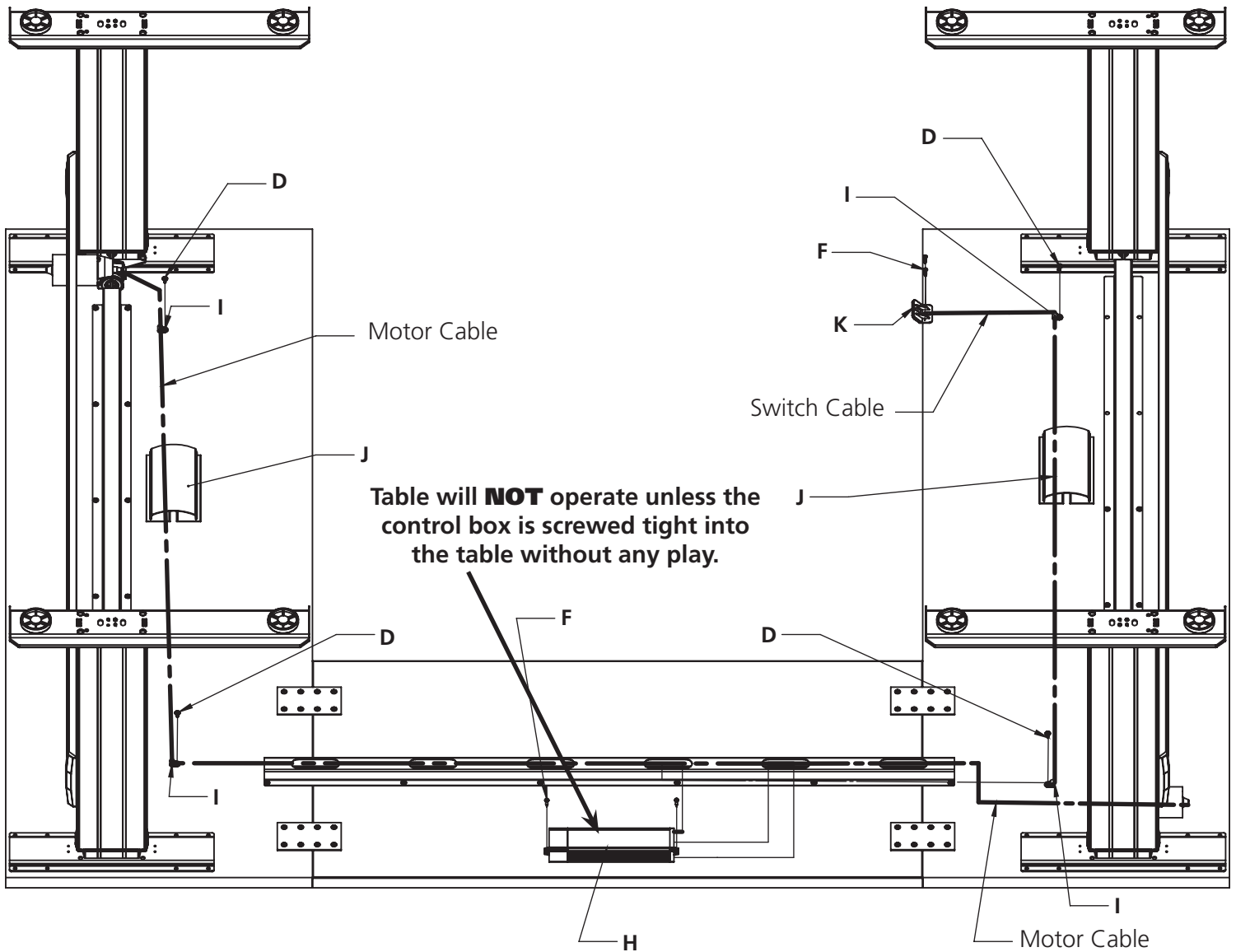
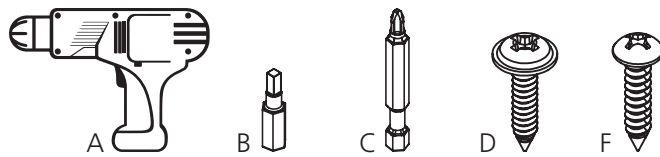

Caution: For the safety of the user and the workstation; the control box contains an internal sensor that is sensitive to movement, vibration, and collision. For faultless operation, ensure

all cables, electronics, and accessories are cable managed and secured. Excessive load or weight must be distributed evenly. Failure to follow these guidelines may cause intermittent functionality.

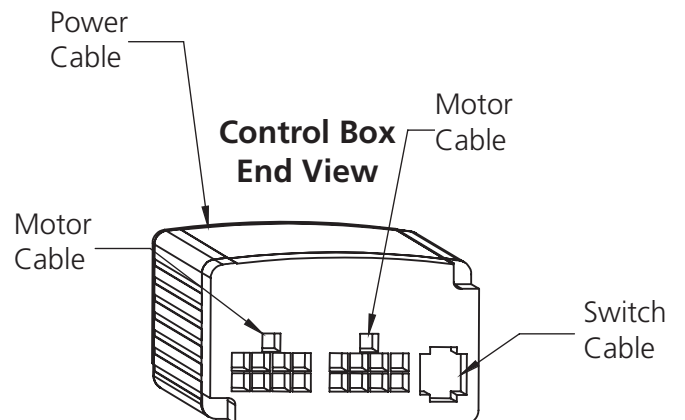

Note

If the leg assemblies are at uneven heights, it is usually caused by an improperly installed hex rod. Disassemble one of the leg assemblies from the worksurface and make sure both ends of the hex rod are properly engaged in the hex drives near the top of the leg assemblies.

Standard Switch Save for Reference

Start Up Procedure:



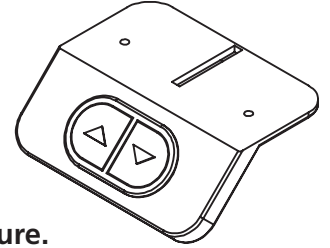









- Plug the power cord into a standard 110V receptacle. A power surge protector is recommended.
- Press the down arrow until the worksurface reaches its lowest position.
- The workstation is ready for use.
- **If the table is not functioning normally or has lost power, perform the reset procedure.**













Reset Procedure:

- Unplug the unit from the wall for 10 seconds.
- Clear all obstructions from the travel path of the desk.
- Plug the unit back in the wall.
- Press and hold the down arrow key until the table reaches its lowest position.

Add Container Stops:

- Move the table  to the upper or lower desired height.
- Rapidly press  4 times. You will hear a musical tone. 
- Rapidly press  2 times. A musical tone plays two times.  
 - To **add** the **upper** container stop press  A musical tone plays two times.  
 - To **add** the **lower** container stop press  A musical tone plays two times.  

Remove Container Stops:

- Move the table  to the upper or lower **preset** height.
- Rapidly press  4 times. You will hear a musical tone. 
- Rapidly press  2 times. A musical tone plays two times.  
 - To **delete** the **upper** container stop press  You will hear a musical tone. 
 - To **delete** the **lower** container stop press  You will hear a musical tone. 

Troubleshooting:

If you are having any problems with the operation, contact RightAngle Products at **800.298.4351** or **orders@raproducts.com**

Optional Programmable Switch (full instructions packaged with switch)

Start Up Procedure:

- Plug the power cord into a standard 110V receptacle. A power surge protector is recommended.
- Press the down arrow until the worksurface reaches its lowest position.
- The workstation is ready for use.
- **If the table is not functioning normally, or has lost power, perform the reset procedure.**

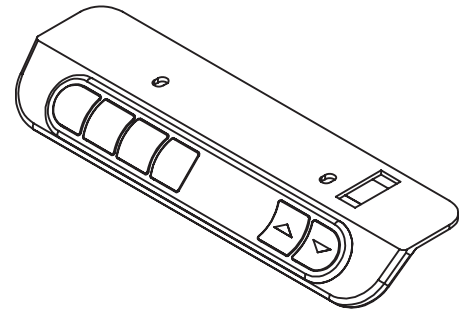

Reset Procedure:

- Unplug the unit from the wall for 10 seconds.
- Clear all obstructions from the travel path of the desk.
- Plug the unit back in the wall.
- Press and hold the down arrow key until the table reaches its lowest position

See Packaged Instructions for Programmable Options

Mechanical Reset Mode

If the table is unresponsive, uneven, or not functioning properly, perform a manual reset.











User settings are not reset in this process.

There are three methods to reset a workstation:

Reset Method A















1. Clear all obstructions from the travel path of the workstation
2. Disconnect the power to the control box for 30 seconds.
3. Reconnect the power
4. Press and hold the  until the workstation has reached its lowest possible position.

Reset Method B (4 button programmable switch required)

1. Clear all obstructions from the travel path of the workstation
2. Quickly press  +  +  +  to enter the menu mode.
3.  is displayed and you will hear a musical tone. 
4. Press the   to navigate the menu.
5. Navigate to the  display
6. Press the  button to enter or accept
7. Press and hold the  until the workstation has reached its lowest possible position.

The workstation is now ready to operate

Reset Method C - 2 Button Switch

1. Clear all obstructions from the travel path of the workstation
2. Quickly press  +  +  +  to enter the menu mode.
3. You will hear a musical tone. 
4. Press  +  +  + 
5. You will reach the limit adjustment menu and hear four musical tones.    
6. Press and hold the  until the workstation has reached its lowest possible position.

The reference is re-calibrated, the table should be leveled and the height indication should be correct.