

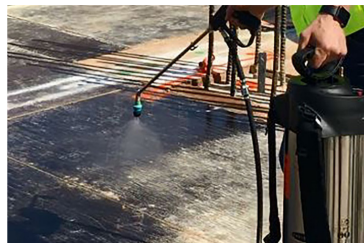

# Civil Infrastructure Solutions

Product Guide





Work confidently with the most recognised brands in wet concrete construction across Australia.



# Contents

---

## Our Story

pg 04

---

## Our Commitment to Civil

pg 05

---

## Durable Concrete Solutions

pg 06

---

## Our Civil Products

pg 07

---



## Concrete Connections & Bracing

pg 08 - 13

Reid™ Elephant Foot™ Ferrule  
Metric Bolted Connection System  
pg 10 - 11

Reid™ Concrete Panel Bracing  
& Placement Solutions  
pg 12 - 13

## Precast Lifting & Reinforcing Supports

pg 14 - 23

Reid™ SwiftLift™ General Lifting  
Systems pg 16 - 19

Reid™ Precast Edge Lifting  
Systems pg 20 - 21

Reid™ Precast Reinforcing  
Plastic Supports pg 22 - 23

---



## Slab-on-Ground, Floor & Pavements

pg 24 - 31

Danley™ Slab-on- Ground Load  
Transfer Systems pg 26 - 29

Danley™ Slab-on-Ground  
Reinforcing Plastic Supports  
pg 30 - 31

Danley™ Pavement Systems  
pg 32 - 36

# Our Story

---



**Reid™ Construction Systems (RCS) is a division of Illinois Tool Works (ITW) a Fortune 500 diversified manufacturing company, which brings together the combined skills and expertise of market leading brands - Reid™ and Danley™.**

Specialising in engineering solutions for wet concrete construction, we work with developers, builders, specifiers, precasters, subcontractors, distributors, and the wider industry, to support and advance concrete construction. Operating on the belief that advances in concrete technology and engineering solutions provide new opportunities to build faster, safer, and more efficiently. With manufacturing hubs located in Melbourne and Brisbane, Reid Construction Systems services the Australian and New Zealand concrete construction industry across the residential, industrial, commercial, and civil construction sectors through our distribution centres in Melbourne, Brisbane, Sydney, Perth, Auckland, and Christchurch.

## Our Brands

---



**Danley™ offers innovative, engineered joint management solutions for suspended floors, slab-on-ground concrete floors and pavements for the industrial, commercial, and residential sectors.**

With a history spanning over 25 years, Danley is an iconic Australian brand synonymous with quality designed and manufactured engineered load transfer, joint edge protection and crack control systems. Recognising a need within the industry to provide durable floors for today's materials handling and warehousing systems, residential slabs and pavements - our Danley™ branded solutions incorporate research, design and product testing into every product we manufacture.

[www.danley.com.au](http://www.danley.com.au)

---



**Reid™ offers the complete package of engineered lifting, reinforcing, connection and architectural solutions for the commercial and civil construction sectors.**

Reid™ has a proud legacy spanning over 100 years servicing the Australian and New Zealand construction industry through industry pioneering work and leadership - from Reid's genesis in the 1920s with wire rope, to the introduction of pre-stressed concrete in the 60s, to reinforcing systems for in-situ construction in the 90s. Reid is firmly focused on providing innovative concrete solutions, with a strong commitment to safety, quality and compliance. Specialised in providing best-in-class technical support to ensure projects are engineered for efficiency, cost-effectiveness, and safety.

[www.reid.com.au](http://www.reid.com.au) | [www.reids.co.nz](http://www.reids.co.nz)

---

# Our Commitment to Civil

---

**RCS aims to instill confidence in building with concrete. With high-quality products, expert guidance, and educational resources on offer, RCS is an industry leading supply partner throughout Australia and New Zealand:**

---

## ✓ We leave nothing to chance.

Our products are designed, developed, and thoroughly tested to perform to local conditions and to industry standards. With state of the art, in-house testing facilities and a team of highly skilled and experienced engineers, thorough testing, including in-concrete testing and independent lab assessments, put our performance claims under the microscope. Quality and Compliance are key priorities in ensuring our customers can trust our brands to perform, each and every time.

## ✓ We behave as trusted advisors

We partner with our customers and the industry as trusted advisors, who are intimately connected to the success and advancement of concrete construction. We work closely with the industry regulators to ensure we provide a best-in-class quality and compliant market offer, in-conjunction with key government legislation and engineering laws. This will ensure RCS delivers concrete solutions that last a lifetime and meet higher standards demanded by regulators and industry stakeholders.

## ✓ Quality & Compliance

We believe the industry should never have to doubt the engineered concrete solutions they choose - the success of our customers' projects is our success. That's why our products are made to high quality standards and subjected to strict independent testing procedures, in conjunction with our own in-house testing centre that plays a critical role in the delivery of concrete solutions that not only meets, but exceeds the standards demanded by industry regulators.

## ✓ Research and Development

At RCS, innovation starts with our customers through our unique customer-back innovation process. We strive to innovate by deeply understanding our customers' needs that result in solutions to meet their specific requirements. With a team of nine R&D experts, we go beyond regulatory compliance to ensure products have been validated through rigorous testing. In addition, our performance claims are verified by chartered registered engineers. So, you can trust that our products will perform as promised!

## ✓ Local Manufacturing

RCS has a significant commitment to Plastic Injection Moulding, Steel Fabrication and Roll Forming. We're working hard every day on ways to improve our operational efficiency whilst creating meaningful and sustainable improvements through the use of recycled materials where appropriate. With safety, quality, and sustainability as our highest priorities, RCS prides itself on continued investment to local manufacturing and to provide the capabilities and capacity to meet the needs of the Australian and New Zealand construction industry.

## ✓ Engineering & Design

Employing over 25 engineers, bank on our value engineering support throughout the life of the construction process. Our team comprises of registered, qualified, experienced engineers across Design Services, Field Engineering, and R&D throughout Australia and New Zealand, providing technical product assistance, on-site support, and value-add design services. We partner with our customers to find the optimal solution, eliminate unnecessary costs & improve productivity - whilst never compromising on safety.

### Our Engineering team can offer:

- ✓ Concrete lifting designs for precast construction.
- ✓ Engineering information and design for the application of Reid and Danley products in unique situations.
- ✓ Engineering assessment and testing to find the most optimal solution.

# Durable Concrete Solutions

Our concrete construction products provide durable solutions for transport, utilities, defense, and more. From roads to wind turbine foundations, our expertise offers reliable Solutions that last for decades.



## Transport Infrastructure (Roads, Bridges, Tunnel, Airports, Rail, Ports, Logistics Hubs)

Concrete construction for transport infrastructure involves the use of concrete as a primary building material for various projects such as roads, bridges, tunnels, airports, rail lines, ports, and logistics hubs. Concrete is a durable, cost-effective, and versatile material that can withstand heavy traffic and harsh environmental conditions.

Quick reference icon



## Utilities (Water, Energy)

Concrete construction is also widely used for utilities such as water and energy infrastructure. Water treatment plants, reservoirs, and pipelines are often constructed with concrete due to its ability to withstand the harsh environment and corrosive nature of water. Concrete dams are also commonly used to control water flow and generate hydroelectric power.

Quick reference icon



## Resources (Mining)

Concrete construction is also essential in the mining industry. The mining industry relies on concrete structures to provide a safe and efficient working environment for workers and equipment. Concrete is used in various mining applications, including mine shafts, tunnels, and other underground structures.

Quick reference icon



## Defence / Surveillance

Concrete construction plays an important role in defense and surveillance infrastructure. Concrete is often used to construct buildings and structures that house equipment and personnel for surveillance and security purposes.

Quick reference icon



# Our Civil Products



Reid™ offers the complete package of engineered lifting, reinforcing, connection and architectural solutions for the commercial and civil construction sectors.



## Precast Lifting and Reinforcing Supports



SwiftLift™  
General Lifting



3Dx™  
Edge Lifting

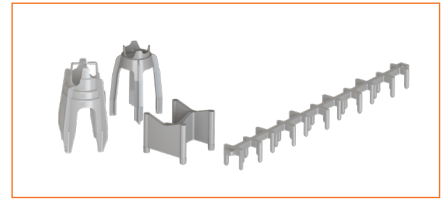

Reid™ Precast Reinforcing  
Plastic Supports



## Concrete Connections, Bracing & Precast Panel Placement



Reid™ Elephant Foot™ Ferrule  
Metric Bolted Connection System

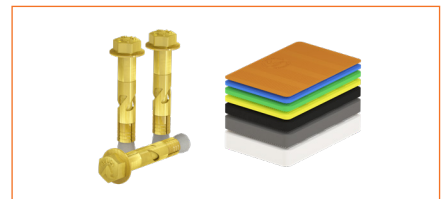

BraceSet™ Bracing Anchor &  
Reid™ Panel Shims



Danley™ offers innovative, engineered joint management solutions for suspended floors, slab-on-ground concrete floors and pavements for the Civil sectors.



## Slab-on-Ground, Floor And Pavements

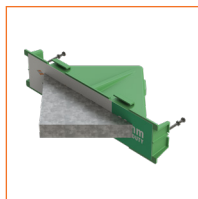

Diamond™  
Dowels



PD3™ Dowel  
Cradles



Flanged  
Dowel Box



SOG Plastic Bar  
Chairs

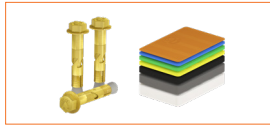

## Concrete Connections, Bracing & Precast Panel Placement

**Our comprehensive range of advanced solutions encompasses concrete connections, bracing systems, and precise panel placement techniques, ensuring superior results for your projects.**

With our cutting-edge bracing systems, we prioritise stability and safety during concrete panel installation, significantly reducing accidents and increasing overall productivity. These systems are meticulously designed using state-of-the-art materials and precision engineering, guaranteeing exceptional durability to withstand the demands of any construction project.

Our expertise extends beyond bracing solutions. We specialise in optimising panel placement, offering tailored strategies and specialised equipment to ensure precise and efficient installations. Our expert team provides dedicated guidance throughout the entire process, maximising efficiency and ensuring successful project outcomes.

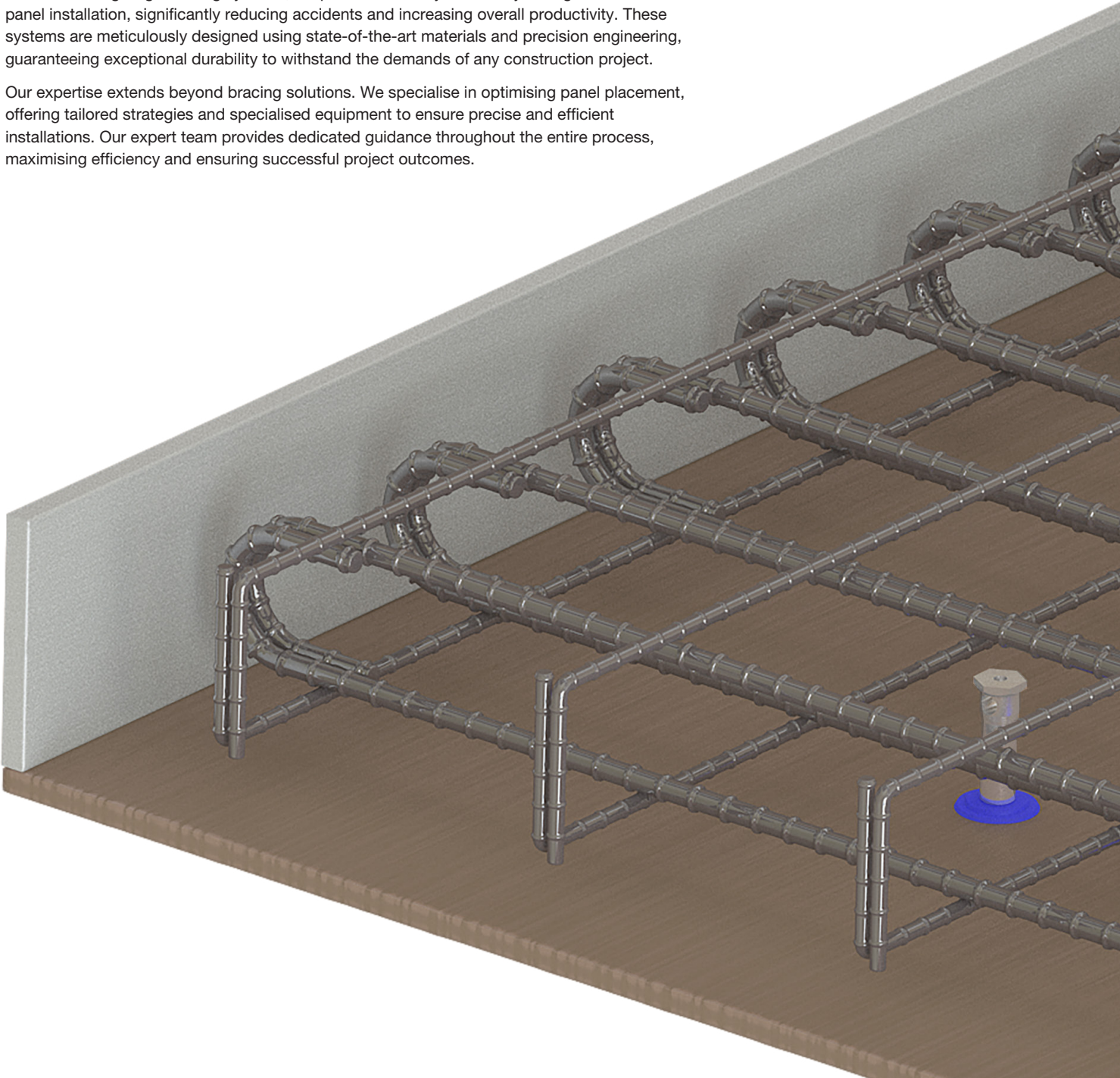

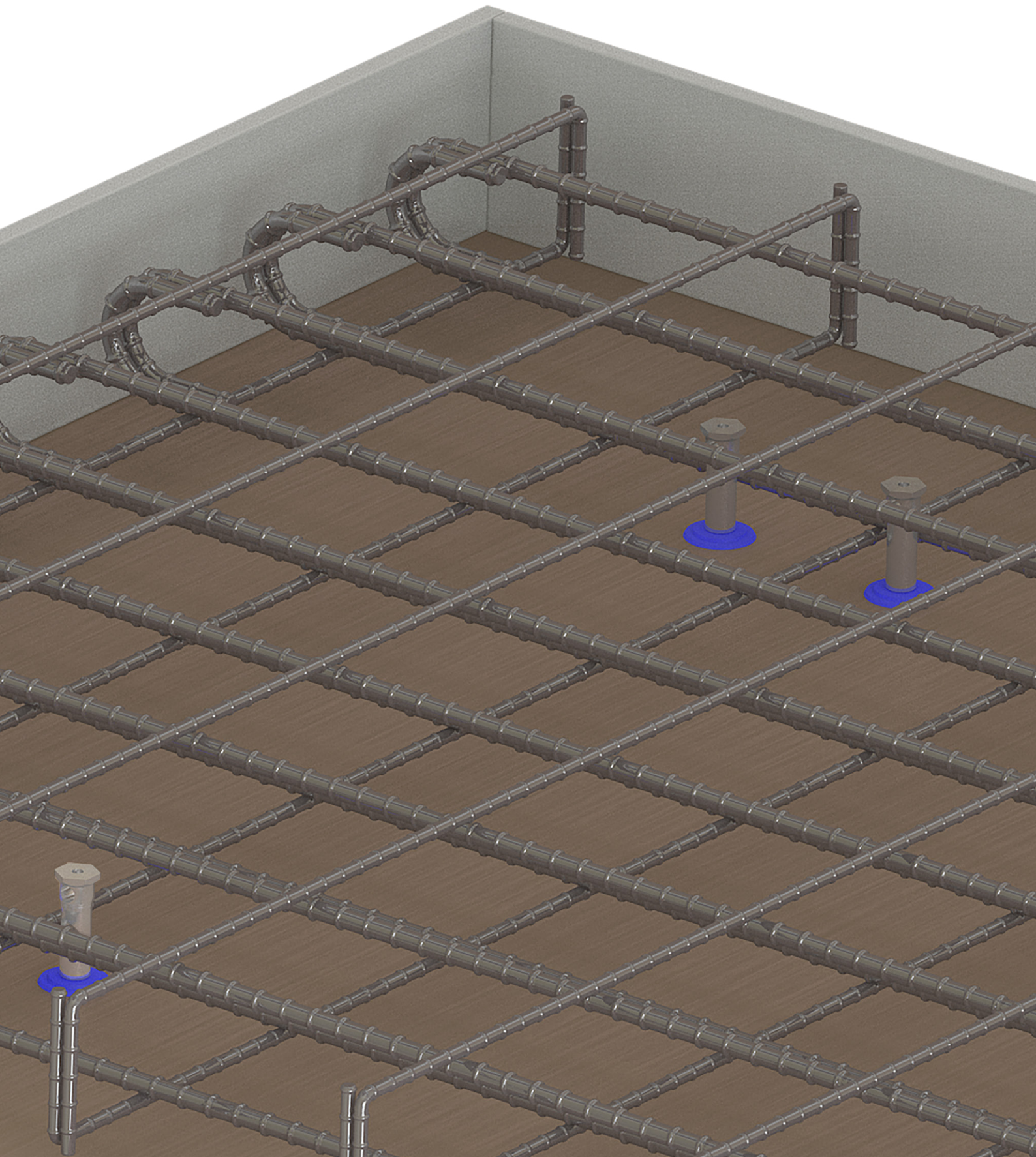

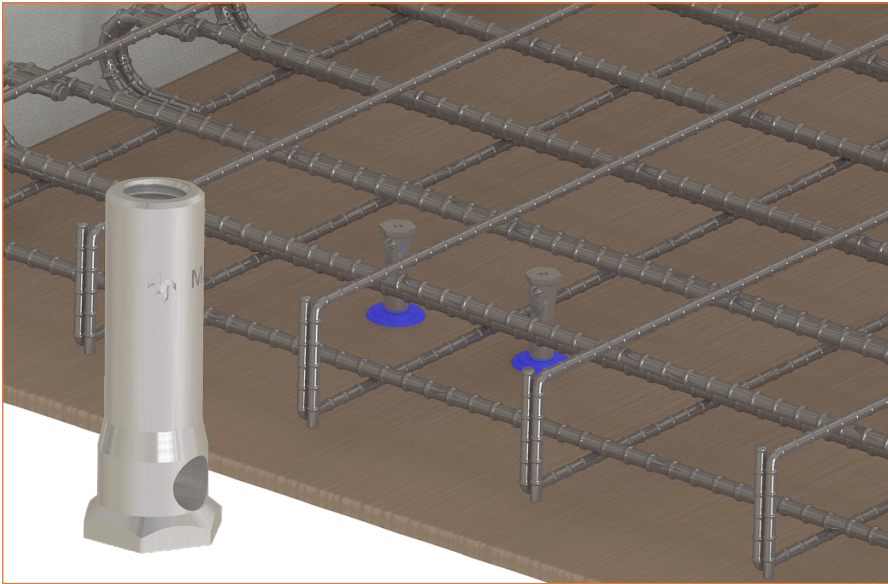

## Reid™ Elephant Foot™ Ferrule Metric Bolted Connection System



The Reid™ Elephant Foot™ Connection System has been designed to provide a cast-in metric bolting and fixing solution for the precast concrete industry.

This system is particularly useful for civil infrastructure projects, where the need for a reliable and efficient connections is paramount. With the accessory range, the Elephant Foot™ Ferrule Connection System is easy to install in precast panel installations and provides a secure bolted connection, ensuring the fixture remains in place under challenging conditions.

One of the key benefits of the Reid™ Elephant Foot™ Connection System is versatility. This system can be used in bridges, tunnels, and other civil infrastructure projects. It is suitable for precast concrete walls, floors, and structural elements. The Elephant Foot™ Connection System is designed for metric threaded bolts and fixings, ensuring suitability for construction applications.

### Civil Environments & Applications



#### Transport Infrastructure

- Services (pipework, electrical, water)
- Structural Steel • Bracing • Accessways (Pedestrian access facilities) • Tunnel segments • Scaffolding



#### Utilities

- Pipework • Vessels and equipment • Scaffolding
- Services (pipework, electrical, water)



#### Resources

- Processing Equipment • Safety Guarding
- Worker Facilities Scaffolding • Services (pipework, electrical, water)



#### Defence

- Maintenance Facilities • Building Fit out
- Communication Towers • Scaffolding
- Services (pipework, electrical, water)

### Key Features & Advantages



316 grade Stainless Steel or 5.8 grade steel for temporary work solutions.



Use in near or far face applications with our range of accessories.



Footed design ensures maximum concrete capacity without the need for a cross bar.



Waisted design ensures capacity is not limited by the steel strength at the cross hole.



Cross hole to suit N12 on larger sizes.



May be used with rebar for fixing to mesh.



Fully Compliant with the requirements of AS3850.1:2015 (+A1:2019).

This product complies with the requirements of AS 3850:2015 (+A1:2019)\*

**System Compatibility: Reid™ Metric Bolted Connection System**





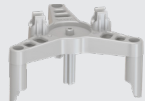

**10mm Reid™ Elephant Foot™ Ferrule System:**

Ferrule	Nail Plate (Nail)	Nail Plate (Stick-On)	Chair	Antennae Cap	Locator Cap
 <b>SS</b> FE10045SS	N/A	N/A	N/A	N/A	N/A

**12mm Reid™ Elephant Foot™ Ferrule System:**

Ferrule	Nail Plate (Nail)	Nail Plate (Stick-On)	Chair	Antennae Cap	Locator Cap
 <b>SS</b> FE12055SS	 FM12N	 NP12GLUE + NPSPOT	 FSC100, FSC25, FSC50, FSC75	 ANTCAPM12	N/A

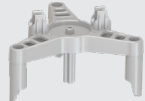
**16mm Reid™ Elephant Foot™ Ferrule System:**

Ferrule	Nail Plate (Nail)	Nail Plate (Stick-On)	Chair	Antennae Cap	Locator Cap
 <b>SS</b> FE16070SS	 FM16N	 NP16GLUE + NPSPOT	 FSC100, FSC25, FSC50, FSC75	 ANTCAPM16	 FWFL16

**20mm Reid™ Elephant Foot™ Ferrule System:**

Ferrule	Nail Plate (Nail)	Nail Plate (Stick-On)	Chair	Antennae Cap	Locator Cap
 <b>SS</b> FE20095SS	 FM16N	 NP16GLUE + NPSPOT	 FSC100, FSC25, FSC50, FSC75	 ANTCAPM16	 FWFL16

**Please Note:**

Metric Threaded Inserts also available in Zinc & Galv. finish for Additional construction applications (Including temporary works). Please contact your local Reid representative for a full list of sizes available.



This product complies with the requirements of AS 3850:2015 (+A1:2019)\*

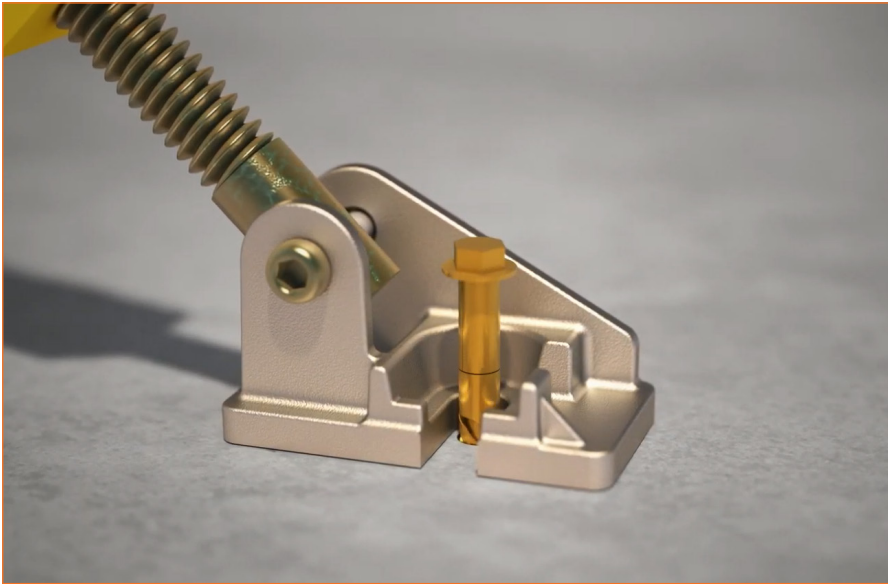

## Reid™ Concrete Panel Bracing & Placement Solutions



Reid™ is a leading provider of precast design, fabrication, lifting, and installation solutions.

Our Reid™ BraceSet™ Post installed anchors and Reid™ Plastic Shims are two product ranges that provide significant benefits when installing and securing precast concrete panels onto construction sites. Our BraceSet™ Post installed anchors are specifically designed for installing braces to precast panels, providing a secure and reliable connection between the panels, brace and the supporting structure.

Our design team can assist with tailoring the solutions to your specific needs, ensuring that the BraceSet™ Post installed anchors are the perfect fit for your project. Being designed for temporary works, the BraceSet™ Post installed anchor is easy to install and can be used in a wide range of applications. Our team of experts can work with you to determine the best solution for your project, ensuring that the BraceSet™ Post installed anchors are installed correctly and provide the necessary support for your precast panels.

### Civil Environments & Applications



#### Transport Infrastructure

- Pile Caps • Headstocks / crossheads
- Ground beams • Foundation structures
- Tunnel portals • Cut & cover structures • Viaducts



#### Utilities

- Water tank wall joints • Tank Stitching Joints
- RC Dam walls • Pump housings • Tank bases
- Wind turbine bases



#### Resources

- Underground Structures
- Material Offload Facility • Retaining Structures



#### Defence

- Conventional Buildings

### Key Features & Advantages



Reid™ Panel Shims have been designed for the temporary leveling & support of precast elements.



Reid™ Panel Shims are manufactured in our ISO accredited Australian factory.



Reid™ Panel Shims are marked with the Reid logo & 20t WLL for easy identification.



BraceSet™ Anchor includes 30mm AF Head. Designed to span across the brace foot slot structurally, ensuring a stable fitting every time.



BraceSet™ Anchor Pull Down Sleeve reduces in height, drawing the fixture down tight to the brace foot & substrate as it is torqued for a secure fix.



BraceSet™ Anchor Simple Removal of the bolt fixture from the substrate, leaving no messy protrusions & eliminating the need for cutting or hot works.

This product range complies with the requirements of AS 3850:2015 (+A1:2019)\*

### Part Numbers & Specifications: Reid™ BraceSet™ Bracing Anchor

Large 30mm AF head and 38mm washer.

High shear capacity for a 20mm diameter anchor.

Pull down sleeve ensures fixture clamping.

Heavy duty, thick expansion sleeve.

Locking cone nut engages the concrete.

**Industry Approved**

Part No.	Description	Pack Qty	Anchor Size	Tensile	Shear
BA20115	Reid BraceSet Bracing Anchor	40	M14	16.2	43.4

### Part Numbers & Specifications: Reid™ Panel Shims

Product Codes	Shim Thickness (mm)	Dimensions (mm)	Working Load Limit (WLL)	Colour	Pack Qty
SHIM01	1	150 x 100	20t	Brown	100
SHIM02	2	150 x 100	20t	Blue	200
SHIM03	3	150 x 100	20t	Green	100
SHIM05	5	150 x 100	20t	Yellow	100
SHIM10	10	150 x 100	20t	Black	40
SHIM15	15	150 x 100	20t	Grey	40
SHIM20	20	150 x 100	20t	White	30



## Concrete Lifting Systems

Reid™ revolutionised the safety & speed of concrete lifting systems in the 1970s with the swiftlift lifting system. this system utilised a fully engineered approach, combining cast in lifting anchors, recess foramer and specific lifting clutches.

Our commitment to safety, speed & quality within the precast industry is as strong now as it was then. with the development of the 3Dx™ edge lifting system, Reid™ continues to support advancement within the precast industry by offering best in class lifting systems & engineering support.







## Reid™ SwiftLift™ General Lifting Systems



Reid™ SwiftLift™ Lifting Anchors, Clutches and accessories make lifting concrete components easy, efficient and safer during transportation, rigging and lifting of precast concrete elements.

The SwiftLift™ system is a comprehensive solution that incorporates a range of specialized components to enhance lifting operations. By integrating cast-in lifting anchors, recess formers, and custom-fitting lifting clutches, this system offers a fully engineered approach. The utilization of the SwiftLift™ system leads to a reduction in failures, resulting in significant time and cost savings by minimizing damage and construction delays. The 1.3t and 2.5t Foot Anchors, specifically designed to withstand heavy loads, are manufactured using high tensile steel. This material selection ensures enhanced strength and durability, further reinforcing the reliability of the SwiftLift™ system.

### Civil Environments & Applications



#### Transport Infrastructure

- Bridge Beam (Super T, U Beam, L-beam), • Culverts
- Pipes • Concrete Slabs (Water Overflow) • OTEs
- Wall Panels • RSS Embankment Wall Systems
- Kerbs and Bridge Fascias • Noise Barriers • Piles



#### Utilities

- Tilt Up • Pre-Cast Tank Panels
- Pre-Cast Lids • Pipes



#### Resources

- Tilt Up • Planks • Plinths • Slabs
- Culverts • Pipes • Retaining Walls



#### Defence

- Tilt Up • Pre-Cast Panels
- Pre-Cast Flooring

### Key Features & Advantages

- ✓ Foot, Combination & Eye anchors are versatile; allowing a lifting solution to almost all precast element lifts.
- ✓ All foot and eye anchors are made from ductile steel and hot dipped galvanised to AS 4680 for corrosion resistance.
- ✓ Complies with AS3850.1:2015 (+A1 2019) standards.
- ✓ 1.3t & 2.5t foot anchors are manufactured from high tensile steel for added strength.
- ✓ Tested in concrete. our data is derived from 500+ in-concrete tests.
- ✓ Ideal for heavy precast concrete elements like bridge beams.
- ✓ Offers deeper anchorage and increased load capacity.

**System Compatibility: Reid™ SwiftLift™ Foot Anchor**



**1.3 Tonne Reid™ SwiftLift™ Foot Anchor System:**

Foot Anchor Part No.	Lifting Clutch	Void Former
 1FA045H, 1FA055H, 1FA066H, 1FA085H, 1FA120H, 1FA240H	 1LE	 1RFRO, 1SRFRO, 1SRFROART



Reid™ SwiftLift™ Lifting Systems comply with AS3850.1:2015 (+A1).

Please refer to the relevant Compliance Document for further information.

**2.5 Tonne Reid™ SwiftLift™ Foot Anchor System:**

Foot Anchor Part No.	Lifting Clutch	Void Former
 2FA055H, 2FA075H, 2FA090H, 2FA120H, 2FA170H	 2LE	 2RFRO, 2SRFRO, 2SRFROART



**5 Tonne Reid™ SwiftLift™ Foot Anchor System:**

Foot Anchor Part No.	Lifting Clutch	Void Former
 5FA075, 5FA095, 5FA120, 5FA170, 5FA240	 5LE	 5RFRO, 5SRFRO, 5SRFROART



**10 Tonne Reid™ SwiftLift™ Foot Anchor System:**

Foot Anchor Part No.	Lifting Clutch	Void Former
 10FA150, 10FA200, 10FA340	 10LE	 10RFRO

**20 Tonne Reid™ SwiftLift™ Foot Anchor System:**

Foot Anchor Part No.	Lifting Clutch	Void Former
 20FA250, 20FA340, 20FA500	 20LE	 20RFRO



**32 Tonne Reid™ SwiftLift™ Foot Anchor System:**



Foot Anchor Part No.	Lifting Clutch	Void Former
 32FA700	 32LE	 32RFRO

This product complies with the requirements of AS 3850:2015 (+A1:2019)\*



## System Compatibility: Reid™ SwiftLift™ Combination Anchor System

### 1.3 Tonne Reid™ SwiftLift™ Combination Anchor System:

Combination Anchor	Lifting Clutch	Void Former
		
1REA05, 1REA065	1LE	1RFRO, 1SRFRO, 1SRFROART

**Standards Compliance\*** 

Reid™ SwiftLift™ Lifting Systems comply with AS3850.1:2015 (+A1).

Please refer to the relevant Compliance Document for further information.



 **Industry Approved**

### 2.5 Tonne Reid™ SwiftLift™ Combination Anchor System:

Combination Anchor	Lifting Clutch	Void Former
		
2REA090	2LE	2RFRO, 2SRFRO, 2SRFROART



### 5 Tonne Reid™ SwiftLift™ Combination Anchor System:

Combination Anchor	Lifting Clutch	Void Former
		
5REA090, 5REA120	5LE	5RFRO, 5SRFRO, 5SRFROART



**Safety is your number one consideration when lifting concrete elements.** 

This product complies with the requirements of AS 3850:2015 (+A1:2019)\*

## System Compatibility: Reid™ SwiftLift™ Eye Anchor System



### 10 Tonne Reid™ SwiftLift™ Eye Anchor System:

Eye Anchor	Lifting Clutch	Void Former
		
<b>10EA180</b>	<b>10LE</b>	<b>10RFRO</b>



Reid™ SwiftLift™ Lifting Systems comply with AS3850.1:2015 (+A1). Please refer to the relevant Compliance Document for further information.



### 20 Tonne Reid™ SwiftLift™ Eye Anchor System:

Eye Anchor	Lifting Clutch	Void Former
		
<b>20EA250</b>	<b>20LE</b>	<b>20RFRO</b>



### 32 Tonne Reid™ SwiftLift™ Eye Anchor System:

Eye Anchor	Lifting Clutch	Void Former
		
<b>32FA700</b>	<b>32LE</b>	<b>32RFRO</b>



Safety is your number one consideration when lifting concrete elements. 

This product complies with the requirements of AS 3850:2015 (+A1:2019)\*

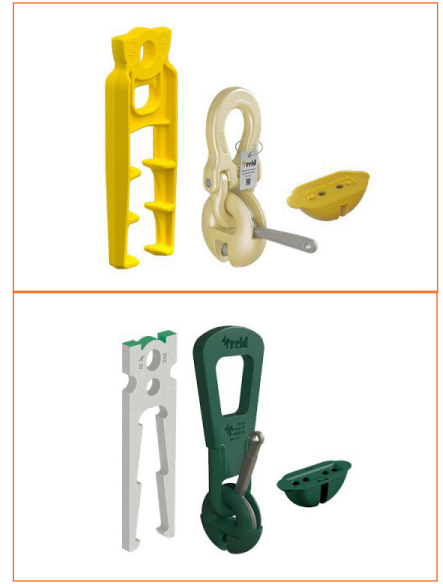

## Reid™ Precast Edge Lifting Systems



Reid™ edge lifting systems are designed to allow for faster & safer manufacture of precast elements, where the anchor is cast into the edge, minimising the need for post installed rectification vs facelifting.

Reid™ edge lift anchors are specifically designed for use in precast wall panels. Suitable for use in elements from 100mm, Reid™ edge lifting systems consist of a specific anchor, void former, & clutch. Along with Reid’s engineering design team, we can assist you in avoiding significant time & cost pressures which are ever present in the construction industry. the innovative 3Dx™ 10t lifting system contains industry first benefits such as an articulated clutch & anchor shield technologies.

### Civil Environments & Applications



#### Transport Infrastructure

- Bridge Beam (Super T, U Beam, L-beam), • Culverts
- Pipes • Concrete Slabs (Water Overflow) • OTEs
- Wall Panels • RSS Embankment Wall Systems
- Kerbs and Bridge Fascias • Noise Barriers • Piles



#### Utilities

- Tilt Up • Pre-Cast Tank Panels
- Pre-Cast Lids • Pipes



#### Resources

- Tilt Up • Planks • Plinths • Slabs
- Culverts • Pipes • Retaining Walls



#### Defence

- Tilt Up • Pre-Cast Panels
- Pre-Cast Flooring

### Key Features & Advantages



Anchorsheild™ coating mitigates delamination caused by galvanic reactions, while at the same time allows for easy visual QA checks.



Unique 3D design distributes loads in the concrete in three dimensions, maximising capacity while reducing outward bursting loads and potential panel damage.



Less reinforcement (no shear bar) required due to advanced leg profile.



Eliminates concrete spalling in shear to edge and rotational lifts of thin concrete elements.



Complies with AS3850.1:2015 (+A1 2019) for the complete system (anchor, clutch and void former).



Hot dip galvanised for maximum corrosion protection.

This product complies with the requirements of AS 3850:2015 (+A1:2019)\*

**System Compatibility: Reid™ Precast Edge Lifting Systems**



**3 Tonne SwiftLift™ Jaws™ Edge Lifting System:**

Anchor	Lifting Clutch	Void Former
<p><b>SJL</b></p>	<p><b>SJLLC</b></p>	<p>Isometric View:</p> <p>Top View:</p> <p><b>SJLVF</b></p>
<p>Anchor in concrete:</p>		

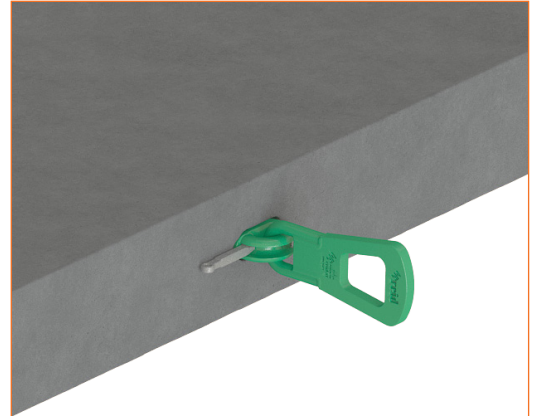

**8.5 Tonne 3Dx™ Edge Lifting System:**

Anchor	Lifting Clutch	Void Former
<p><b>8.5t</b></p> <p><b>3DX85</b></p>	<p><b>3DX85LC</b>    <b>3DX10ALC</b></p>	<p>Isometric View:</p> <p>Top View:</p> <p><b>3DX85VF</b></p>
<p>Anchor in concrete:</p>		

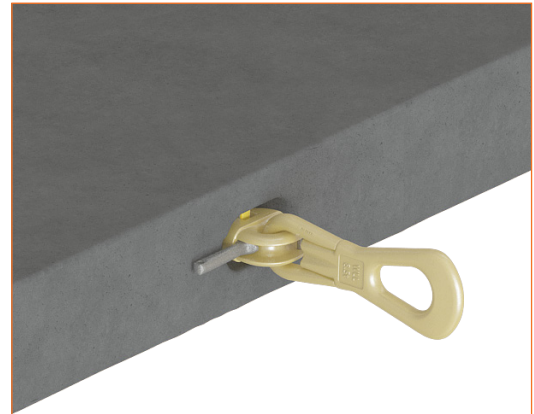

**10 Tonne 3Dx™ Edge Lifting System:**

Anchor	Lifting Clutch**	Void Former
<p><b>10t</b></p> <p><b>3DX10A</b></p>	<p><b>3DX10ALC</b></p>	<p>Isometric View:</p> <p>Top View:</p> <p><b>3DX85VF</b></p>
<p>Anchor in concrete:</p>		

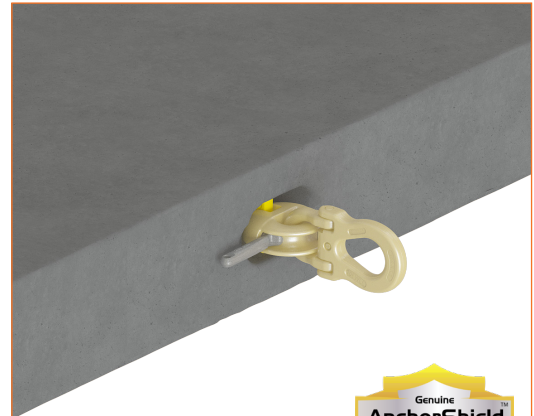

\*\* System is WLL limited to 8.5t when using 3DX85LC  
Please refer to the relevant Compliance Document for further information.

This product complies with the requirements of AS 3850:2015 (+A1:2019)\*

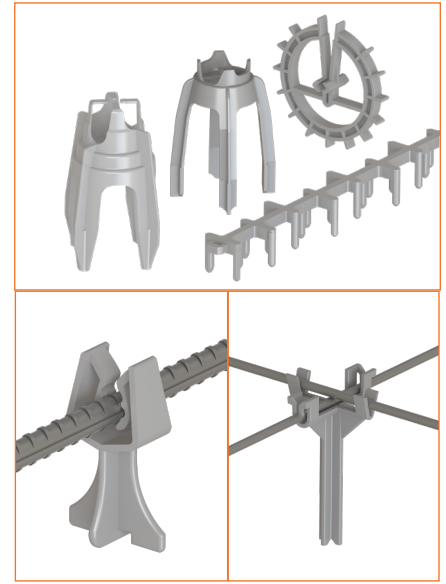
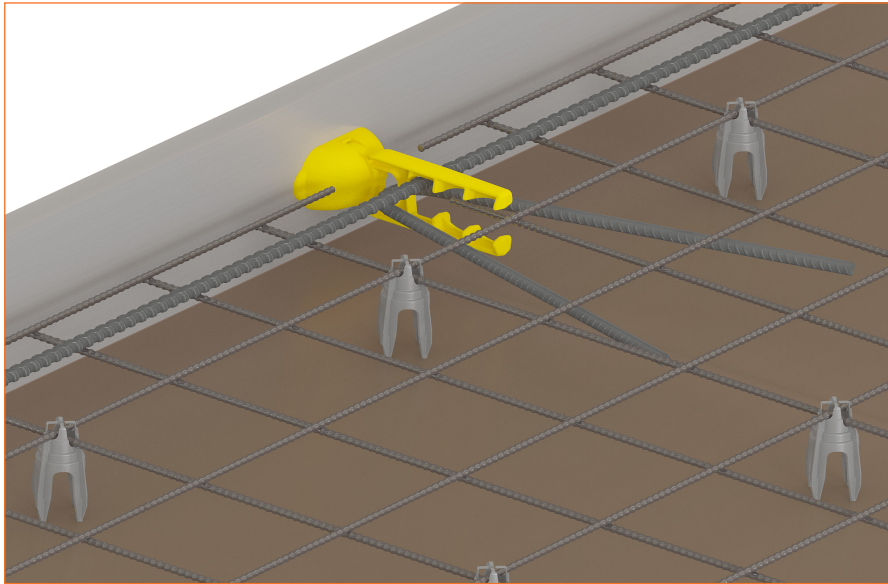

## Reid™ Precast Reinforcing Plastic Supports



Reid™ reinforcement chairs are designed to support all forms of reinforcement in your project. With a wide range of design and cover options, Reid™ chairs provide reliable support while walking over them, without collapsing or tipping.

Many of our chairs feature dimples at the base of their legs, ensuring minimal exposure on the underside. Our chairs are consistently colored in grey to match the concrete. The easy push-on clip mechanism allows for quick and seamless placement, without breakage, and enables the chair to swing into a vertical position as the rebar is lowered into the form. All Reid™ support chairs are proudly Australian-made in our ISO-accredited Melbourne factory.

### Civil Environments & Applications



#### Transport Infrastructure

- Services (pipework, electrical, water)
- Structural Steel • Bracing • Accessways (Pedestrian access facilities) • Tunnel segments • Scaffolding



#### Utilities

- Pipework • Vessels and equipment • Scaffolding
- Services (pipework, electrical, water)



#### Defence

- Maintenance Facilities • Building Fit out
- Communication Towers • Scaffolding
- Services (pipework, electrical, water)

### Key Features & Advantages

- ✓ Australian Made in a ISO accredited factory.
- ✓ Compliant to AS/NZS 2425 : 2015.
- ✓ Batch tested.
- ✓ Various options to support all of your support chair needs.
- ✓ Stable & provide superior strength, ensuring when you place a Reid support chair will maintain the cover required, even after traffic.

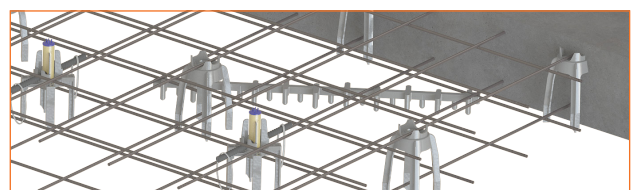

This product complies with the requirements of AS/NZS 2425:2015\*

## System Compatibility: Reid™ Precast Reinforcing Plastic Supports



	Circular Spacer	Mesh Chair	Fast Clip Bar Chair	Panel Chair	Deck Rail	Bottom Deck Chair	Top Deck chair	
COVER	15	CB15CR12	-	-	-	-	-	
	20	CB20CR12	MESH20	FCB20	-	-	-	
	25	CB25CR12	MESH25	FBC25	-	BDR025	BPD2530	
	30	CB30CR12	MESH30	FCB30	BCPANEL3040	BDR030	BPD2530	
	35	-	MESH35	FCB35	-	BDR035	BPD3540	
	40	CB40CR12	MESH40	FBC40	BDCPANEL3040	BDR040	BPD3540	
	45	-	-	FCB45	-	BDR045	BPDS4550	
	50	CB50CR12	MESH50	FCB50	BCPANEL5060	BDR050	BPDS4550	
	55	-	-	-	-	BDR055	-	
	60	-	-	FCB60	BCPANEL5060	BDR060	-	
	65	CB65CR12	MESH65	FCB65	BCPANEL6575	BDR065	-	BPDST6575
	75	CB75CR12	MESH75	FCB75	BCPANEL6575	BDR075	-	BPDST6575
	90	-	MESH90	-	BCPANEL90100	-	-	BPDST90100
	100	-	-	-	BCPANEL90100	-	-	BPDST90100
	110	-	-	-	-	-	-	BPDST1101120
	120	-	-	-	-	-	-	BPDST1101120
	130	-	-	-	-	-	-	BPDST130140
	140	-	-	-	-	-	-	BPDST130140
	150	-	-	-	-	-	-	BPDST150160
	160	-	-	-	-	-	-	BPDST150160
170	-	-	-	-	-	-	BPDST170180	
180	-	-	-	-	-	-	BPDST170180	
190	-	-	-	-	-	-	BPDST190200	
200	-	-	-	-	-	-	BPDST190200	

Our Reid™ Plastic Chairs & Spacers comply with AS/NZS 2425:2015

**Please Note:**

MESH60, BDR085, BDR100 are not listed and are Made-to-Order.



This product complies with the requirements of AS/NZS 2425:2015\*

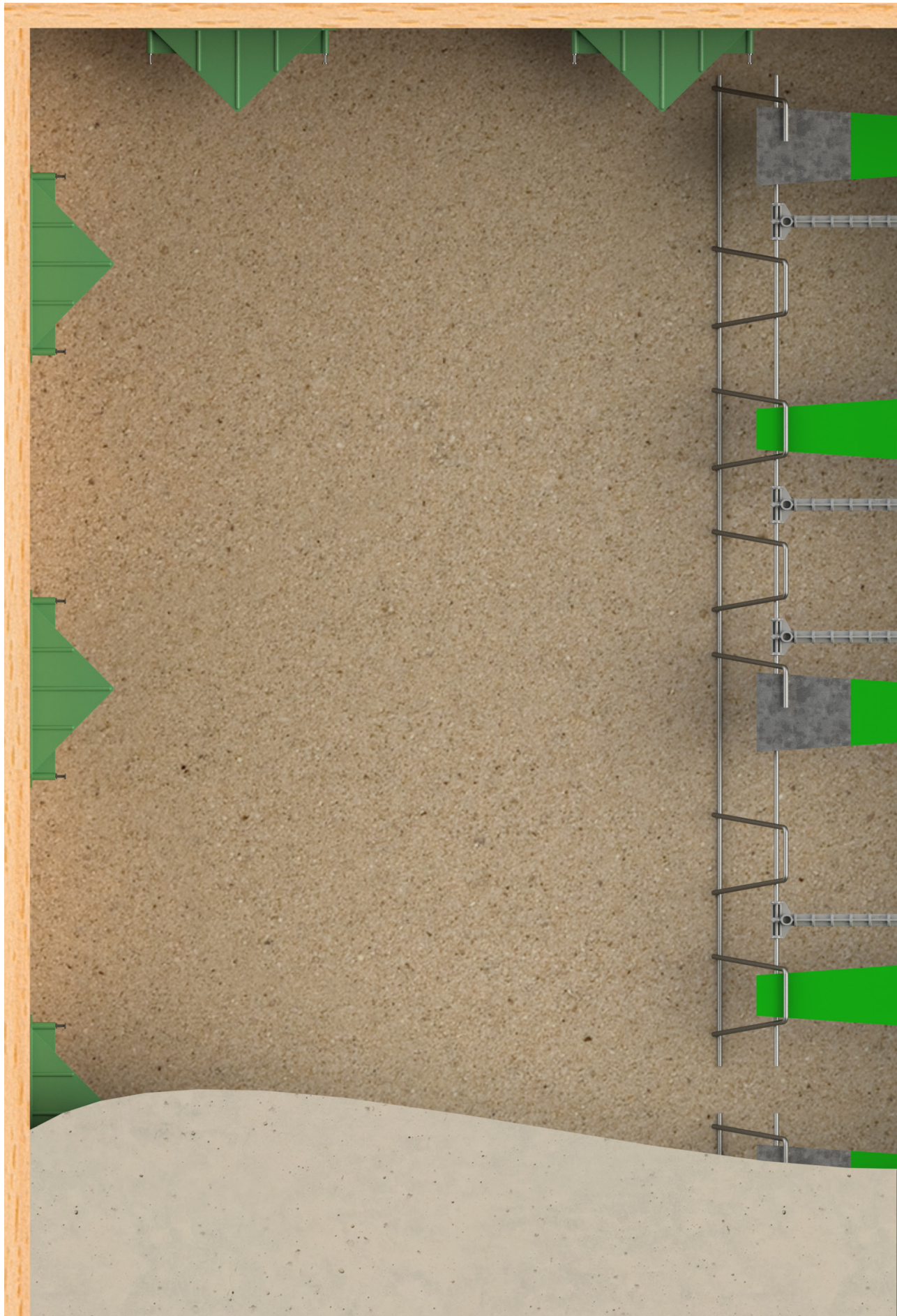

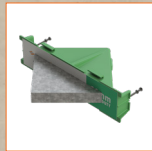
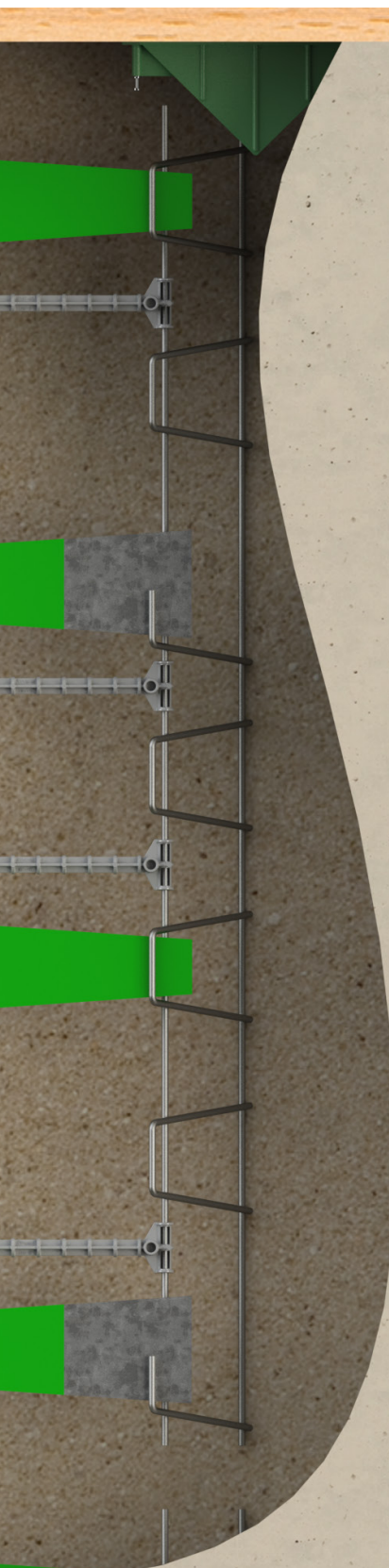

## Slab-on-ground Solutions

At Danley™, we understand the importance of durable and reliable concrete structures. That's why our range of cutting-edge Slab-on-ground solutions are engineered to enhance the performance, efficiency, and longevity of your projects. From joint edge protection to load transfer systems, pavement systems to chairs, spacers, and caps, we provide a complete toolkit to ensure the success of your concrete endeavors.

Our commitment to excellence is reflected in the meticulous design and manufacturing processes of our products. Each item in our range is manufactured to the highest industry standards, adhering to rigorous quality control measures. Whether it's our Danley™ PD3™ Cradle with RynoBar™ system or our Danley plastic chairs and spacers, you can trust in their superior durability and performance.

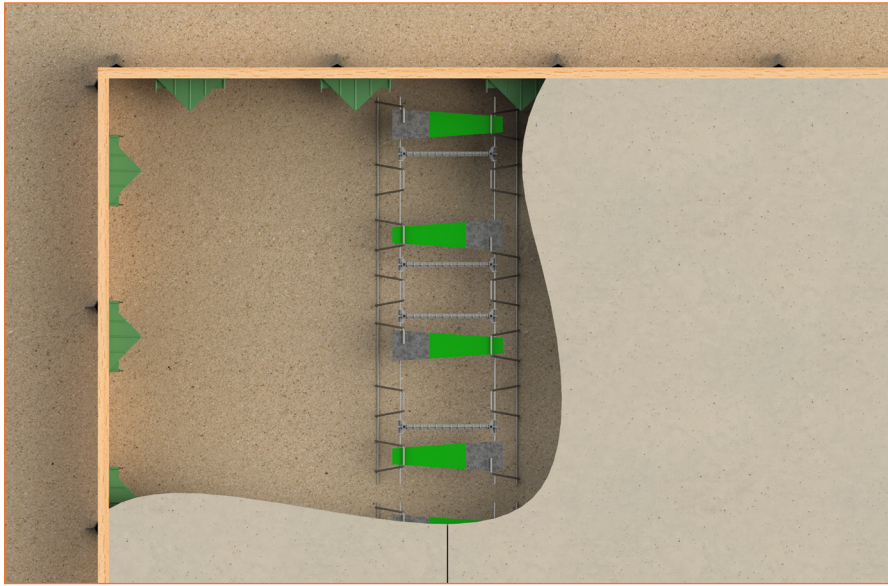

## Danley™ Slab-on- Ground Load Transfer Systems



Joint failure and random cracking of Concrete Slabs are the two most frequent sources of frustration for both tenants and asset owners. A well designed and durable concrete floor that will perform under load must include a load transfer system which provides spall free joints and greatly reduces random cracking.

Diamond™ Dowel AirEx™ provides a low in-place cost solution by eliminating the need for the drilling or processing of formwork that is required with traditional round and square dowel systems. Diamond™ Dowel AirEx™ attaches directly to timber formboard or metal formwork plates and are supplied in pre-packaged Trade Packs with all components ready for installation.

### Civil Environments & Applications



#### Transport Infrastructure

- Airport Apron Hardstand (Ports)
- Intermodal Facilities • Light Rail Rigid Pavement
- Concrete Roads - JRCPC, CRCP • Carparks
- Tunnel Slabs Track and Road • Runways
- Maintenance Hangers • Train Yards



#### Utilities

- Substations (wind farms, solar farms) •
- Powerplants (gas or coal) • Water Tank Bases
- Pump station floors • Hardstand Pavements



#### Resources

- Material Offload Facilities • Maintenance Facilities • Rigid Pavements (Concrete Roads)



#### Defence

- Hard Stand • Rigid Pavements (Concrete Roads) • Maintenance/ storage Facilities • RAAF airfields

### Key Features & Advantages

- ✓ Diamond™ Dowel AirEx™ is a Load Transfer plate dowel and sleeve system designed for construction joint applications in concrete slabs and pavements.
- ✓ Diamond Dowel: Available in 3 Plate Dowel sizes: 6mm (Orange), 10mm Blue) and 20mm (Green).
- ✓ Diamond™ Dowel AirEx™ is a Load Transfer plate dowel and sleeve system designed for construction joint applications in concrete slabs and pavements.
- ✓ PD3™ design features a tapered and sleeveless plate dowel that provides the world's best performance in limiting joint deflection to provide superior joint stability.
- ✓ The PD3™ Dowel Cradle features a plate dowel with bond breaker allowing concrete to contact.
- ✓ Flanged Dowel Box Kits are multi-directional metal sleeves supplied with high capacity square dowels.

This product complies with the requirements of TR34 (4th Edition)

## Part Numbers & Specifications: Danley™ Diamond™ Dowel AirEx™

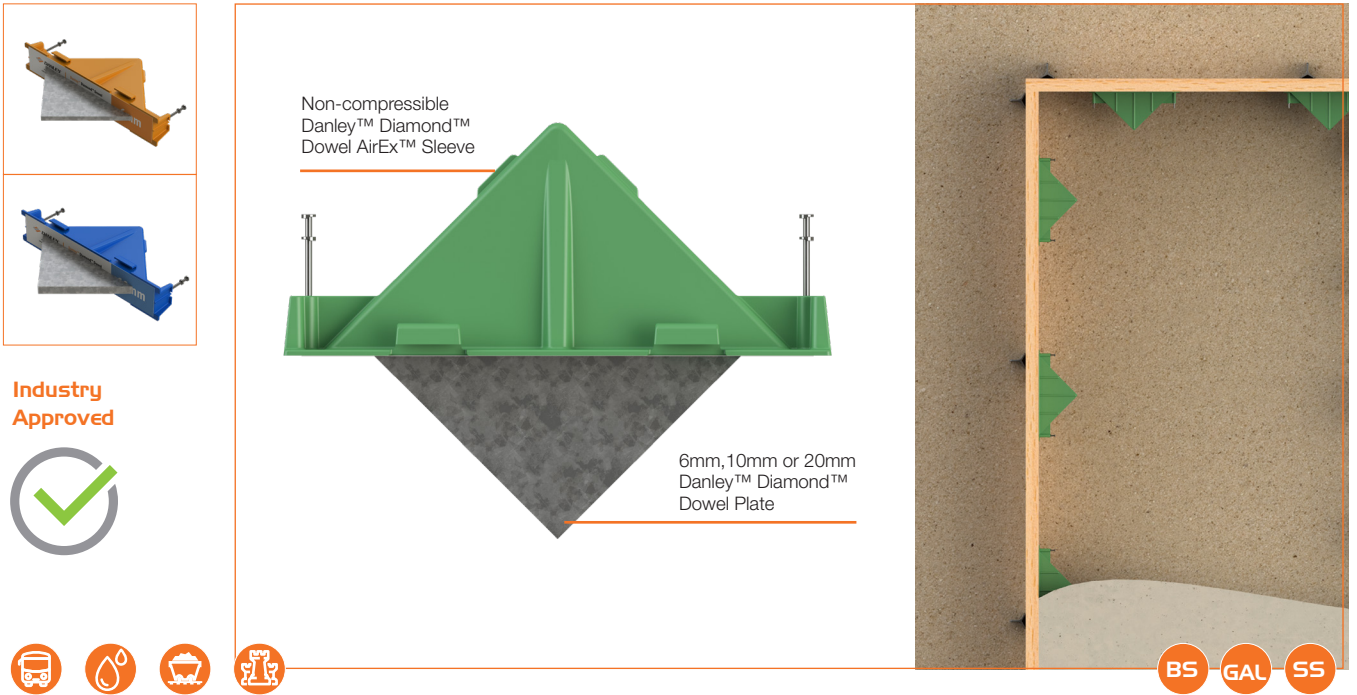

Product Code	Product Description	Dowel Thickness (mm)	Finish	Pack Qty	Pack Weight (kg)
DD06B	Diamond Dowel AirEx 6mm Black	6	Black	15	15.3
DD06BPK	Diamond Dowel AirEx 6mm Black BULK	6	Black	500	270
DD06G	Diamond Dowel AirEx 6mm Galv	6	Galv	25	15.6
DD06GPK	Diamond Dowel AirEx 6mm Galv BULK	6	Galv	500	280
DD06S	Diamond Dowel AirEx 6mm 316 SS	6	316 SS	1*	0.7
DD10B	Diamond Dowel AirEx 10mm Black	10	Black	15	15.1
DD10BPK	Diamond Dowel AirEx 10mm Black BULK	10	Black	500	430
DD10G	Diamond Dowel AirEx 10mm Galv	10	Galv	15	15.2
DD10GPK	Diamond Dowel AirEx 10mm Galv BULK	10	Galv	500	450
DD10S	Diamond Dowel AirEx 10mm 316 SS	10	316 SS	1*	1.0
DD20G	Diamond Dowel AirEx 20mm Galv	20	Galv	7	14.2



This product complies with the requirements of TR34 (4th Edition)

## Part Numbers & Specifications: Danley™ PD3™ Dowel Cradle with RynoBar™

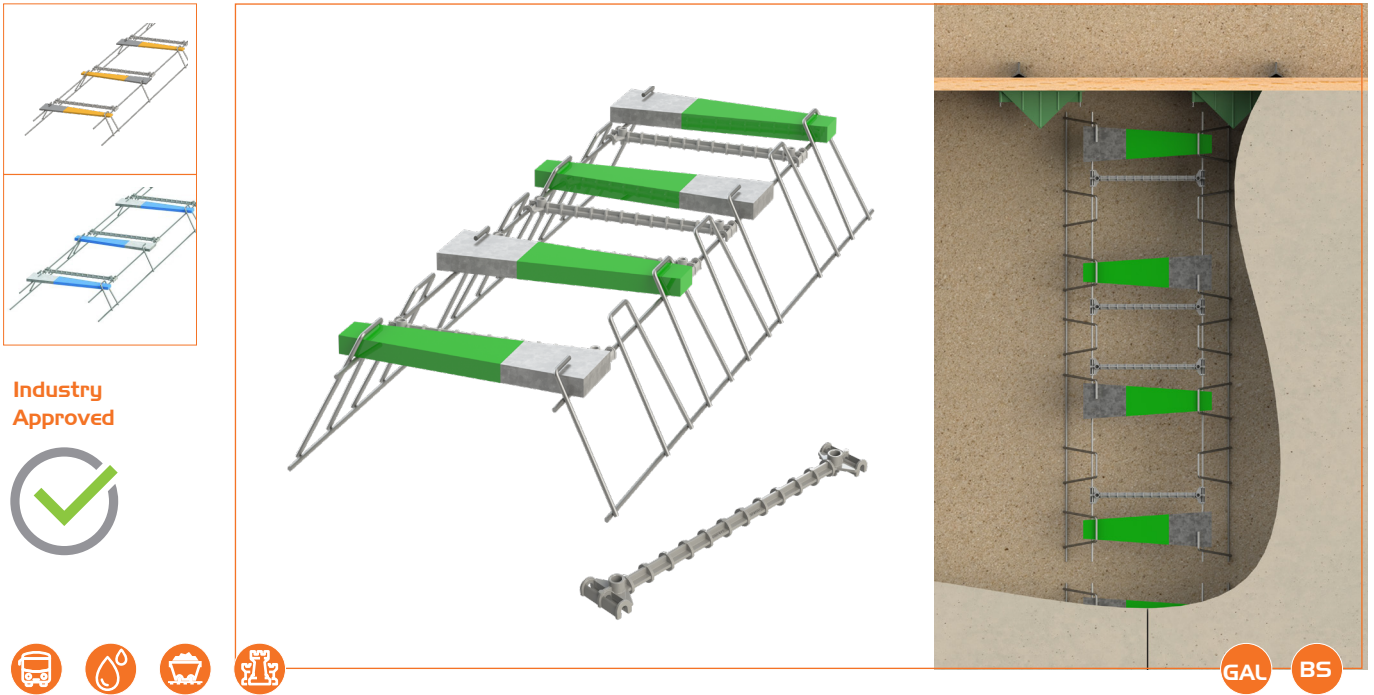

Industry Approved



GAL BS

Product Code	Product Description	Dowel size (mm)	Dowel spacing (mm)	Slab depth range (mm)	Material Finish
PD306450125BLK	PD3 Cradle 06mm @ 450 centres to suit 120-135mm Slab - Black Dowels	6	450	120-135	Black
PD306450125G	PD3 Cradle 06mm @ 450 centres to suit 120-135mm Slab - Galvanised Dowels	6	450	120-135	Galvanised
PD306450150B	PD3 Cradle 06mm @ 450 centres to suit 140-160mm Slab - Black Dowels	6	450	140-160	Black
PD306450150G	PD3 Cradle 06mm @ 450 centres to suit 140-160mm Slab - Galvanised Dowels	6	450	140-160	Galvanised
PD306450175B	PD3 Cradle 06mm @ 450 centres to suit 165-185mm Slab - Black Dowels	6	450	165-185	Black
PD306450175G	PD3 Cradle 06mm @ 450 centres to suit 165-185mm Slab - Galvanised Dowels	6	450	165-185	Galvanised
PD306450200B	PD3 Cradle 06mm @ 450 centres to suit 190-210mm Slab - Black Dowels	6	450	190-210	Black
PD306450200G	PD3 Cradle 06mm @ 450 centres to suit 190-210mm Slab - Galvanised Dowels	6	450	190-210	Galvanised
PD310450150B	PD3 Cradle 10mm @ 450 centres to suit 140-160mm Slab - Black Dowels	10	450	140-160	Black
PD310450150G	PD3 Cradle 10mm @ 450 centres to suit 140-160mm Slab - Galvanised Dowels	10	450	140-160	Galvanised
PD310450175B	PD3 Cradle 10mm @ 450 centres to suit 165-185mm Slab - Black Dowels	10	450	165-185	Black
PD310450175G	PD3 Cradle 10mm @ 450 centres to suit 165-185mm Slab - Galvanised Dowels	10	450	165-185	Galvanised
PD310450200B	PD3 Cradle 10mm @ 450 centres to suit 190-210mm Slab - Black Dowels	10	450	190-210	Black
PD310450200G	PD3 Cradle 10mm @ 450 centres to suit 190-210mm Slab - Galvanised Dowels	10	450	190-210	Galvanised
PD320300250G	PD3 Cradle 20mm @ 300mm centres to suit 225-275mm slab - Galvanised	20	300	225-275	Galvanised
PD320300300G	PD3 Cradle 20mm @ 300mm centres to suit 280-330mm slab - Galvanised	20	300	280-330	Galvanised
PD320400360G	PD3 Cradle 20mm @ 400mm centres to suit 340-390mm slab - Galvanised	20	400	340-390	Galvanised
PD320400425G	PD3 Cradle 20mm @ 400mm centres to suit 400-450mm slab - Galvanised	20	400	400-450	Galvanised

Standards Compliance\*



This product complies with the requirements of TR34 (4th Edition)

## Part Numbers & Specifications: Danley™ Flanged Dowel & Square Dowel Kits



Industry Approved



Product Code	Description	UOM	Pack Qty	Weight (kg)
DWLFLKIT16X220G	Dowel Flanged Box Kit 220mm box with 16 x 400mm Galv Dowel - 20mm Foam	EA	1	1
DWLFLKIT20X220G	Dowel Flanged Box Kit 220mm box with 20 x 400mm Galv Dowel - 20mm Foam	EA	1	2
DWLFLKIT20X220G40	Dowel Flanged Box Kit 220mm box with 20 x 400mm Galv Dowel - 40mm Foam	EA	1	2
DWLFLKIT20X270G	Dowel Flanged Box Kit 270mm box with 20 x 500mm Galv Dowel - 20mm Foam	EA	1	2
DWLFLKIT25X220G	Dowel Flanged Box Kit 220mm box with 25 x 400mm Galv Dowel - 20mm Foam	EA	1	3
DWLFLKIT25X220G40	Dowel Flanged Box Kit 220mm box with 25 x 400mm Galv Dowel - 40mm Foam	EA	1	3
DWLFLKIT32X270G	Dowel Flanged Box Kit 270mm box with 32 x 500mm Galv Dowel - 30mm Foam	EA	1	7
DWLFLKIT40X220G	Dowel Flanged Box Kit 220mm box with 40 x 400mm Galv Dowel - 35mm Foam	EA	1	6

Flanged Dowel Box Kits are multi-directional metal sleeves supplied with high capacity square dowels. They can be attached to metal or wooden formwork with ease with their integral nailing flanges and location marks.

This product complies with the requirements of TR34 (4th Edition)



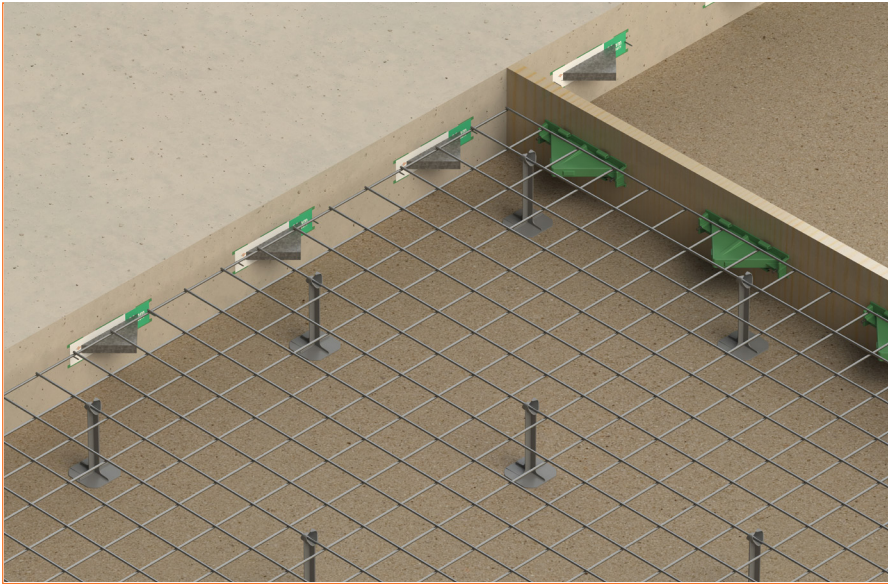

## Danley™ Slab-on-Ground Reinforcing Plastic Supports



Danley™ slab-on-ground plastic chairs and spacers are suitable for a range of applications including residential paths and bikeways, to heavy duty industrial floors and external pavements. Proudly manufactured in Australia, all Danley™ chairs and spacers comply with AS/NZS 2425:2015.

The Danley™ SOG (Slab-On-Ground) Bar Chairs are used to set the reinforcing bar and mesh to the correct position in deeper slabs cast for residential, industrial, commercial and civil slab-on-ground applications.

### Civil Environments & Applications



#### Transport Infrastructure

- Airport Apron Hardstand (Ports)
- Intermodal Facilities • Light Rail Rigid Pavement
- Concrete Roads - JRCPC, CRCP • Carparks
- Tunnel Slabs Track and Road • Runways
- Maintenance Hangers • Train Yards



#### Utilities

- Substations (wind farms, solar farms) •
- Powerplants (gas or coal) • Water Tank Bases
- Pump station floors • Hardstand Pavements



#### Resources

- Material Offload Facilities • Maintenance Facilities • Rigid Pavements (Concrete Roads)



#### Defence

- Hard Stand • Rigid Pavements (Concrete Roads) • Maintenance/ storage Facilities • RAAF airfields

### Key Features & Advantages



Strong and Lightweight design.



Easy to install Clip-On, suits reinforcing bar up to 20mm in diameter.



Easy cover identification on the chairs.



Integral base provides faster installation and placement.



Solid design eliminates any voids under the mesh or reinforcing bar.



Australian Made. The RCS manufacturing facility at Chirside Park (Victoria) is ISO 9001 certified.



Complies with the requirements of AS/NZS 2425:2015.

This product complies with the requirements of AS/NZS 2425:2015\*

**Part Numbers & Specifications: Danley™ SOG Bar Chairs**

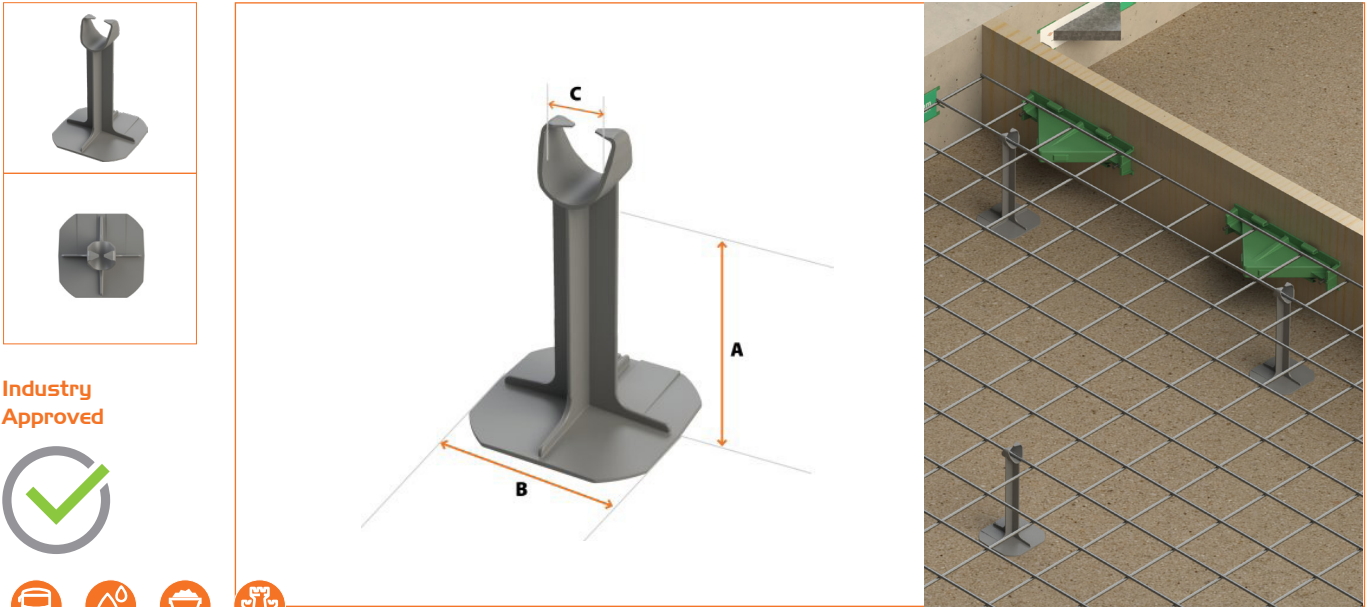

Industry Approved



Product Code	Description	Pack qty (Each)	Pallet qty (pack)	Pallet qty (Each)	Pallet Height	Pallet M3	A (mm)	B (mm)	C (mm) Max bar
BSOG100C	SOG Chair 100mm Clip-On	100	32	3,200	1,150	1.66	100	100	up to 20mm
BSOG110C	SOG Chair 110mm Clip-On	100	32	3,200	1,150	1.66	110	100	up to 20mm
BSOG120C	SOG Chair 120mm Clip-On	100	28	2,800	1,050	1.51	120	100	up to 20mm
BSOG130C	SOG Chair 130mm Clip-On	100	28	2,800	1,180	1.70	130	100	up to 20mm
BSOG140C	SOG Chair 140mm Clip-On	100	24	2,400	1,000	1.44	140	100	up to 20mm
BSOG150C	SOG Chair 150mm Clip-On	100	24	2,400	1,100	1.58	150	100	up to 20mm

The Danley™ SOG (Slab-On-Ground) Bar Chairs are used to set the reinforcing bar and mesh to the correct position in deeper slabs cast for residential, commercial and civil slab-on-ground applications.

This product complies with the requirements of AS/NZS 2425:2015\*



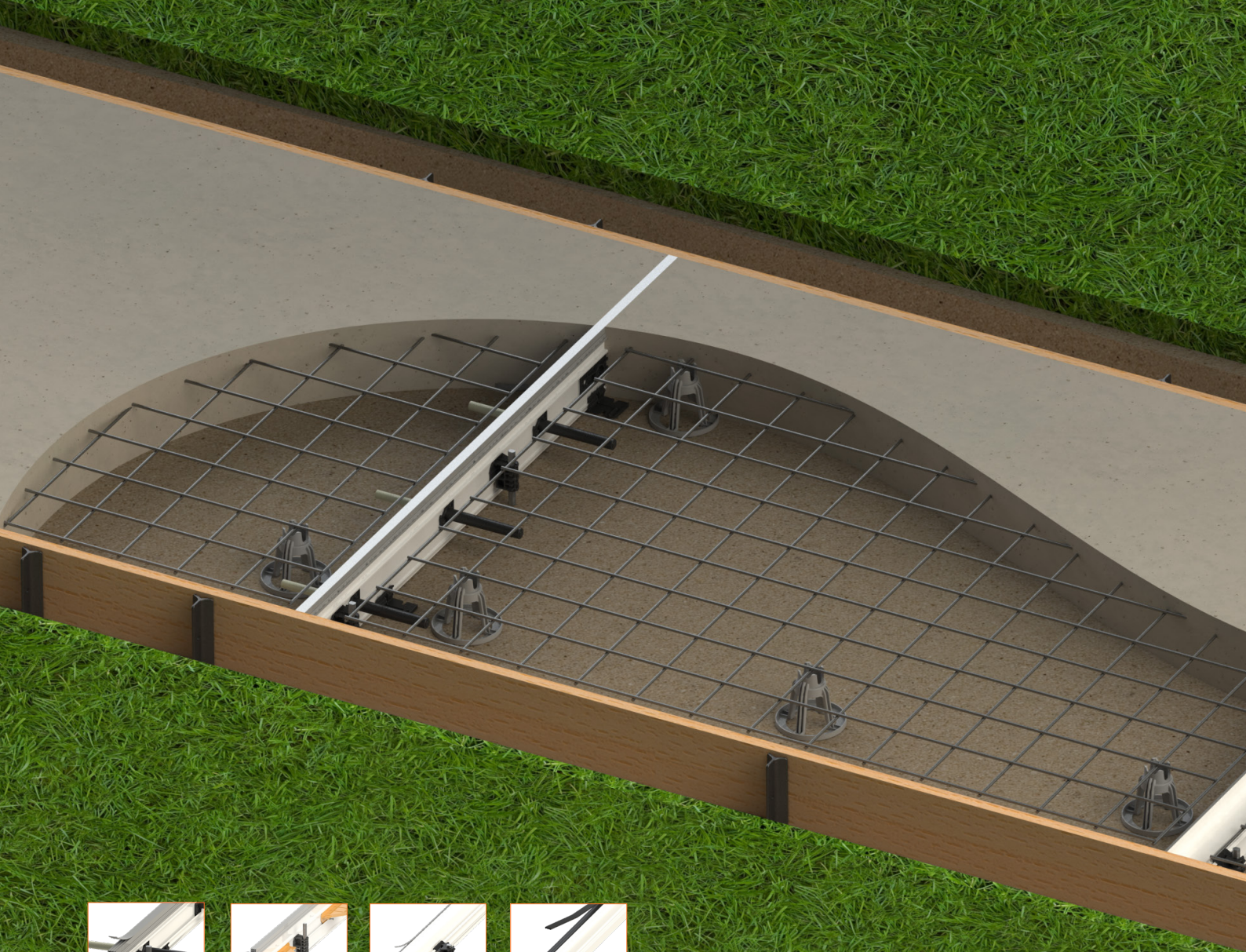

## Pavement Systems

From distribution centres, to warehouses, through to driveways, tennis courts or even a footpath, the Danley range of pavement formwork systems can allow contractors to pour more concrete on a daily basis. With solutions that provide for crack control, load transfer and thermal expansion, our pavement systems meet the requirements of AS 3727:2016.



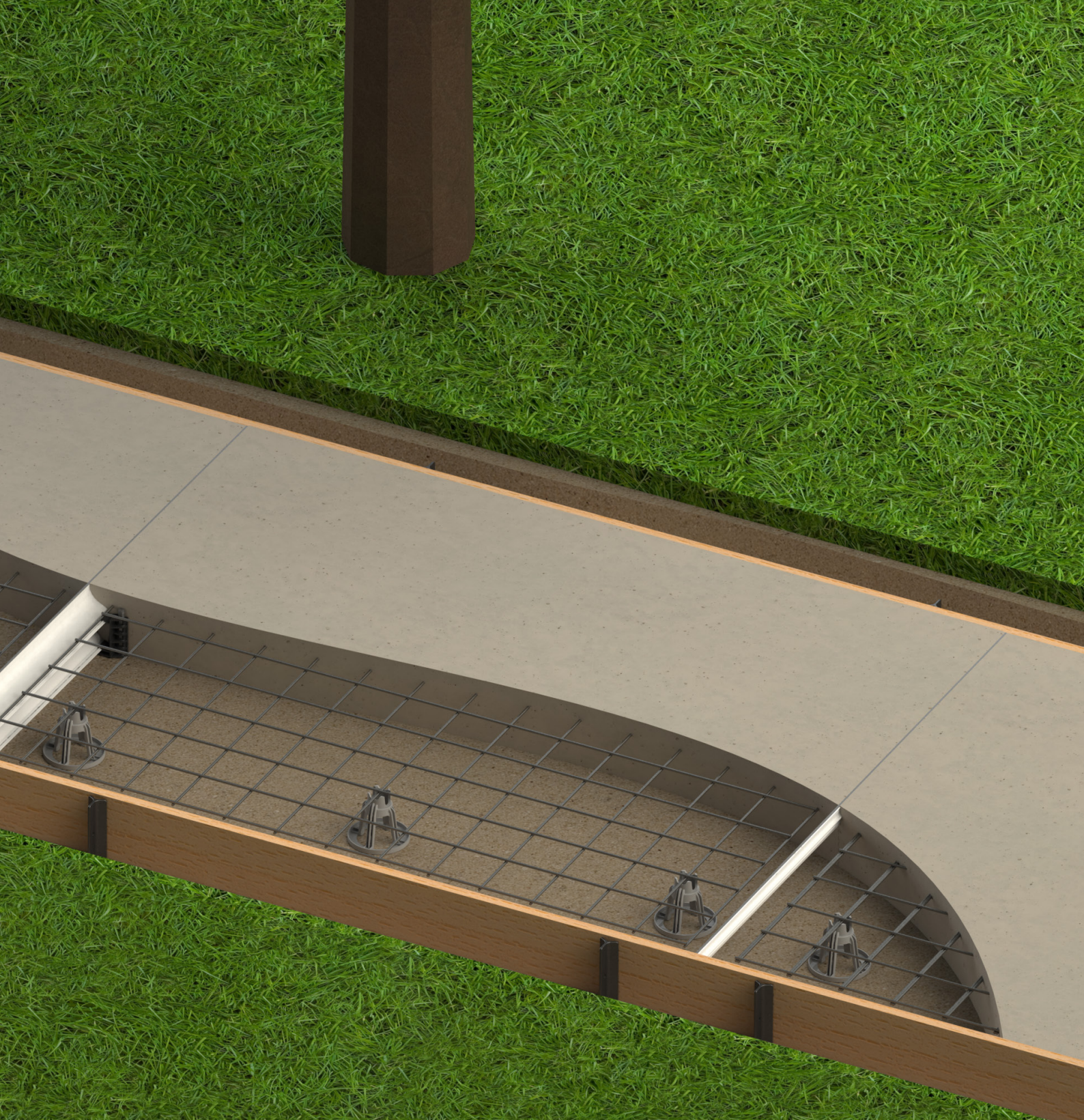

**SMART:** Fully integrated pavement system.

**EFFECTIVE:** Reduces maintenance & repair costs.

**SAFE:** Mitigates trip hazards and public liability exposure.

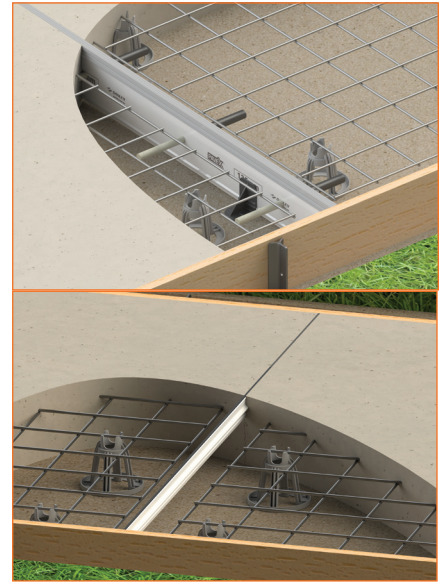
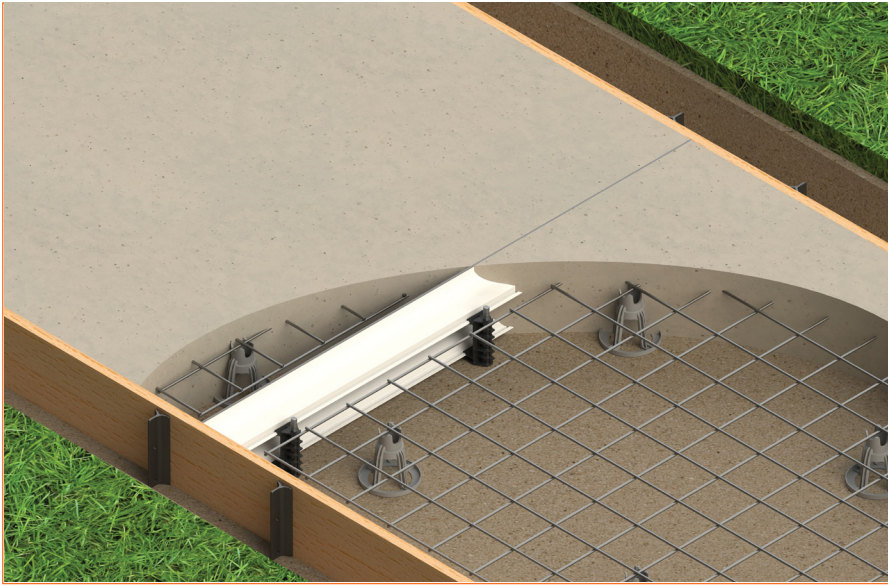

## The Danley™ PaveX™ Eco-System



The Evolution of Residential Pavements starts with PaveX™ Designed and developed in conjunction with councils and concrete contractors alike.

PaveX™ raises the bar as the industry's most comprehensive jointing eco-system for footpaths, bikeways, driveways, urban streetscapes and service vehicle Cross-Overs.



### Civil Environments & Applications



#### Transport Infrastructure

- Cycles Ways • Footpaths • Driveways
- Urban Streetscapes



### Key Features & Advantages

- ✓ EPD certified.
- ✓ Complies with the requirements of AS 3727.1:2016 Residential Pavements.
- ✓ Australian Made.
- ✓ Corrosion Free & UV Stable uPVC
- ✓ Limits deflection and spalling that may cause tripping hazards.
- ✓ Mitigates trip hazards and public liability exposure.
- ✓ Fully integrated pavement system.



#### EPD certified environmentally transparent pavement solution

Leading the way in the industry with Environmental Product Declarations (EPDs) in Australia. EPDs provide you with transparent, product-specific environmental information.

### Danley™ PaveX™ Expanda Kit

PaveX™ Expanda™ is a core component of the broader PaveX™ Residential Pavement eco-system. PaveX™ Expanda™ is a lightweight, corrosion-free and modular expansion joint system that is quick & easy to install.



Product Codes	Description
<b>PX100KIT</b>	PaveX Expanda 100mm 5x3m Lengths with Forms, Dowels & Accessories Kit
<b>PX125KIT</b>	PaveX Expanda 125mm 5x3m Lengths with Forms, Dowels & Accessories Kit

### Danley™ PaveX™ Expanda HD Set

PaveX™ Expanda™ HD is designed specifically for use in heavy duty residential pavement applications including service vehicle cross-overs, driveways, shared bikeways and urban streetscapes.



Product Codes	Description
<b>PX150HDSET</b>	PaveX Expanda 100mm 5x3m Lengths with Forms, Dowels & Accessories Kit
<b>DDSLPL06X110G</b>	PaveX Expanda 125mm 5x3m Lengths with Forms, Dowels & Accessories Kit
<b>DDSLPL06X110S</b>	Diamond Dowel 6mm - 316g Stainless Steel (Inc Sleeve)

### Danley™ PaveX™ Geared™ Kits

PaveX™ Geared™ is designed specifically for concrete footpaths and shared bikeways impacted by soil heave or tree root ingress. An innovative articulating formed control joint system, PaveX™ Geared™ allows for concrete pavement sections to rise and/or fall whilst limiting differential deflection and mitigating tripping hazards



Product Codes	Description
<b>PXG100BKIT</b>	PaveX Geared 100mm 5x3m Lengths with Black Capping Kit
<b>PXG100GKIT</b>	PaveX Geared 100mm 5x3m Lengths with Grey Capping Kit
<b>PXG125BKIT</b>	PaveX Geared 125mm 5x3m Lengths with Black Capping Kit
<b>PXG125GKIT</b>	PaveX Geared 125mm 5x3m Lengths with Grey Capping Kit
<b>PXG150BKIT</b>	PaveX Geared 150mm 5x3m Lengths with Black Capping Kit
<b>PXG150GKIT</b>	PaveX Geared 150mm 5x3m Lengths with Grey Capping Kit
<b>PXGCJ</b>	PaveX Geared Clip-on Joiners 50pc Pack

### Danley™ PaveX™ Crack-A-Joint™

As an alternative to traditional saw cutting and tooled joints, PaveX™ Crack-A-Joint™ with co-extruded Rip-A-Strip™ Capping induces a controlled crack to the full depth of the concrete.



Product Codes	Description
<b>PXCAJ25B</b>	PaveX Crack-A-Joint 25mm 10x3m Lengths with Black capping
<b>PXCAJ25G</b>	PaveX Crack-A-Joint 25mm 10x3m Lengths with Grey capping
<b>PXCAJ38B</b>	PaveX Crack-A-Joint 38mm 10x3m Lengths with Black capping
<b>PXCAJ38G</b>	PaveX Crack-A-Joint 38mm 10x3m Lengths with Grey capping
<b>PXCAJCJ</b>	PaveX Crack-A-Joint Clip-on Joiners 50pc Pack





## Customer Service

sales@itwcsanz.com | 1300 780 250 | [www.reidconstructionsystems.com](http://www.reidconstructionsystems.com)

### Reid™ Construction Systems (RCS) 1 Ramset Drive, Chirside Park 3116

Information in this document is correct at the time of printing. Readers should contact RCS or consult RCS detailed technical information to ensure product is suitable for intended use prior to purchase.  
ITW Australia Pty Ltd ABN 63 004 235 063 trading as RCS  
© copyright, 2023.

**Important Disclaimer:** Any engineering information or advice ("Information") provided by RCS in this document is issued in accordance with a prescribed standard, published performance data or design software. It is the responsibility of the user to obtain its own independent engineering (or other) advice to assess the suitability of the Information for its own requirements. To the extent permitted by law, RCS will not be liable to the recipient or any third party for any direct or indirect loss or liability arising out of, or in connection with, the Information.

