

FEATURES:

1. Material: Tin Plated CU
2. UL listed for U.S. & Canada.
3. Wire connector rated for 35Kv max.
4. Class B/C compressed, concentric, and compact copper conductor only.
5. Expanded wire range when installed with dieless NSi compression tool (N12ID).
6. Dimensions are for reference only, tolerance is +/- .06".

LN Series: L4N-142P



PROGRAM:	SOLIDWORKS
UPDATED:	4/2022
SALES REV:	A
SIZE:	B (11x17)



SCALE 5:2

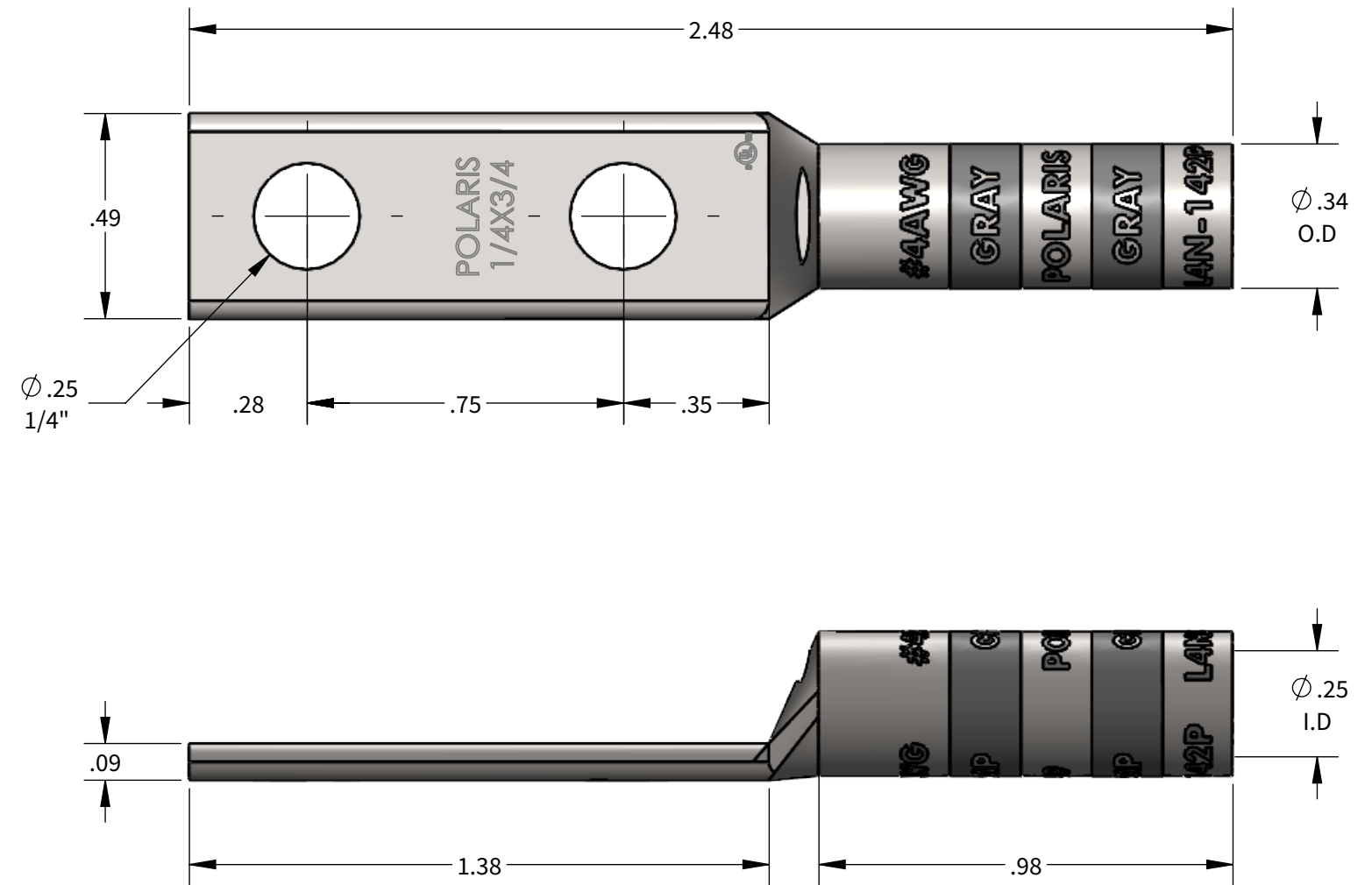

COPPER COMPRESSION CONNECTOR TOOL AND DIE CHART (# OF CRIMPS)

			COPPER COMPRESSION CONNECTOR TOOL AND DIE CHART (# OF CRIMPS)										
			NSI			GREENLEE		ILSCO	BURNDY	T&B	HUSKIE		
WIRE SIZE	STRIP LENGTH	DIE COLOR	EXPANDED WIRE RANGE W/N12ID	N1240 SERIES	NSI-12	NSI-12	1240 SERIES		ILC-12/ILC-15 SERIES	Y-35, Y750, PAT 750	TBM-15, TBM-14M	EP510C	
#4AWG	1-3/16"	GRAY	#4AWG-#6AWG	KC12-4 (2)	CD3 (4)	HT41AU (4)	KC12-4 (2)	ILD-3 (4)	KC12-4(2)	U4CRT (2)	15527-CK (4)	HT41AU (4)	CD3 (4)

