

PROGRAM:	SOLIDWORKS
UPDATED:	11/22/2024
SALES REV:	A
SIZE:	A (8.5x11) (IN)

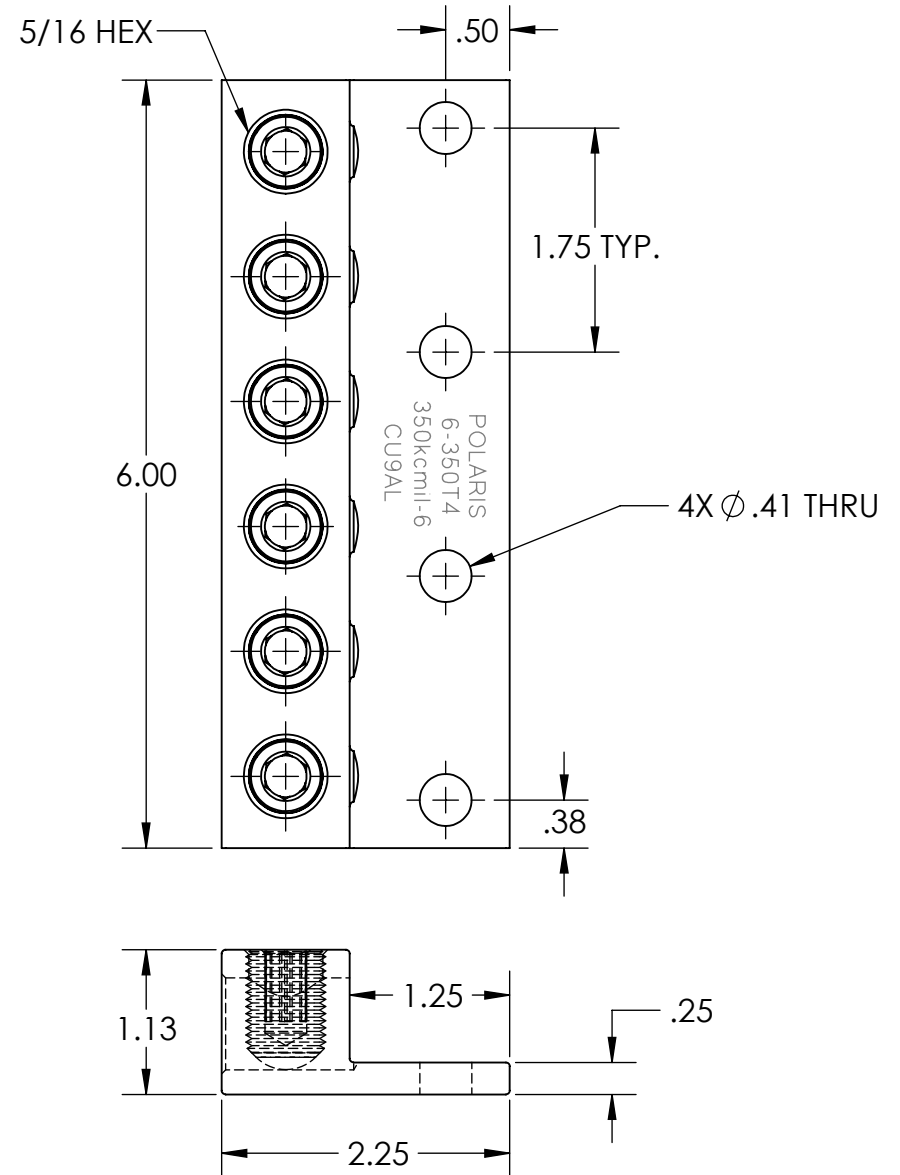

(6) 350KCMIL-6
CONDUCTOR PORTS

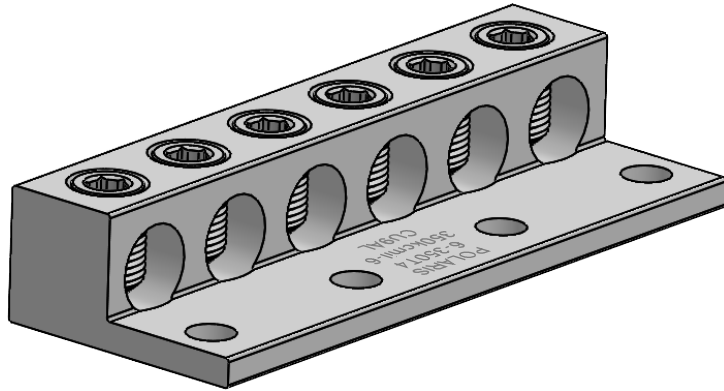
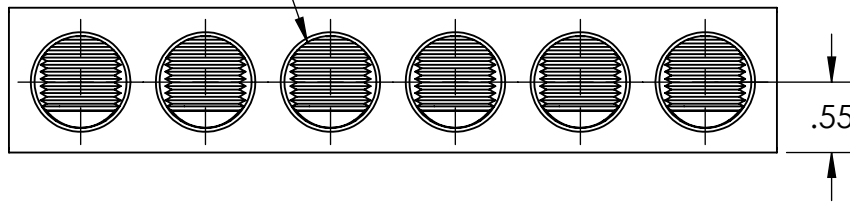

FEATURES:

1. Material: Tin Plated Aluminum.
2. Wire connector rated for 35Kv max.
3. Class B/C compressed, concentric, and compact conductor only.
4. Dual rated AL-CU.