

ATOMO
**INSTRUCTION
MANUAL**
**MANUEL
D'INSTRUCTIONS**
46772
**MANUAL DE
INSTRUCCIONES**
Thank You

You've just purchased a lighting product designed and built to provide you with years of enjoyment.

Merci

Vous venez d'acheter une lumière conçue pour vous donner des années de plaisir.

Gracias

Usted acaba de adquirir un excelente producto de alumbrado diseñado y construido para proveerle muchos años de satisfacción.

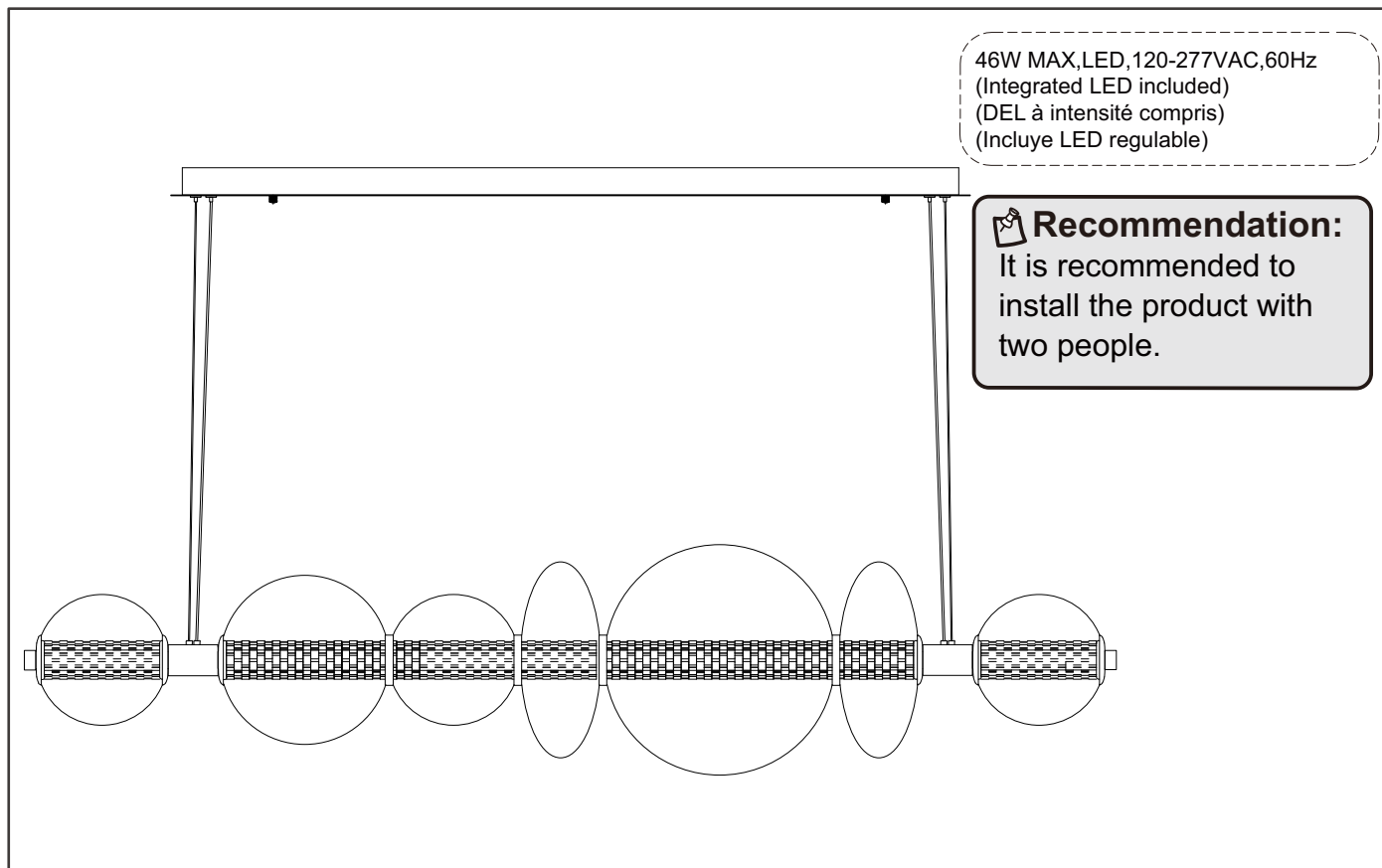











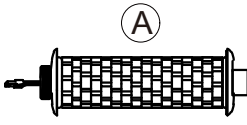

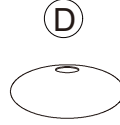

46W MAX, LED, 120-277VAC, 60Hz
(Integrated LED included)
(DEL à intensité compris)
(Incluye LED regulable)

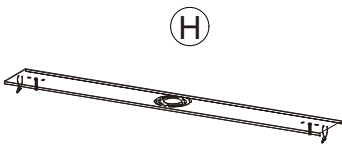
Recommendation:

It is recommended to install the product with two people.

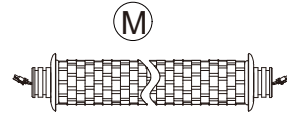
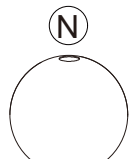
IMPORTANT SAFETY INSTRUCTIONS

- Attention to installer, must test the light fixture before installation.
- Follow the assembly instructions by reading the numerical order.
- Use a qualified electrician for installation of this lighting fixture.
- Before installing fixture disconnect power by turning the circuit breaker or by removing the fuse at the fuse box.
- All electrical connections must be in accordance with local and National Electrical Code or Canadian Electrical Code standards.
- Use CSA or UL certified wire connectors suitable for the gauge, type and number of conductors.
- Wrap the green (or bare copper) grounding wire from the fixture around the green screw on the mounting bracket, then connect it to the grounding conductor of the supply circuit. If junction box has no ground wire, attach the bare copper fixture wire to the green ground screw on the mounting bracket.
- This unit is suitable for installation in a dry, indoor location only.
- This unit is to be mounted to a metal electrical junction box (outlet box) directly supported by the building structure.
- Save this instructions for future reference.
- Estimated Assembly Time: 20 minutes
- Tools Required For Assembly (not included): Flathead screwdriver, Phillips screwdriver, Pliers, Electrical tape and Wire cutters.
- Helpful Tools (not included): Wire strippers, Ladder.

 (A) 2x 49954-029/49954-040 49954-030	 (B) 4x 51078-010/51078-027 51078-034	 (C) 3x 46772-SG1 46772-CG1	 (D) 2x 46772-SG3 46772-CG3	 (E) 1x 46772-SG2 46772-CG2	 (F) 1x	
 (G) 3x	 (H) 1x	 (I) 2x	 (J) 2x	 (K) 4x	 (L) 4x	 (M) 1x 49741-025/49741-018 49741-030
 (N) 1x 46772-SG4/46772-CG4	 (O) 3x 51102-012/51102-029 51102-036	 (P) 2x 51101-015/51101-022 51101-039	 (Q) 1x	 (R) 2x		

ASSEMBLY INSTRUCTIONS

1. Unscrew the preassembled aluminum part (Q) and tube cover (O) from the tube (M).



Note: Only one aluminum part (Q) and tube cover (O) can be unscrew. The fixed part (Q) has stuck a label with word "fixed", please remove this label before installation.

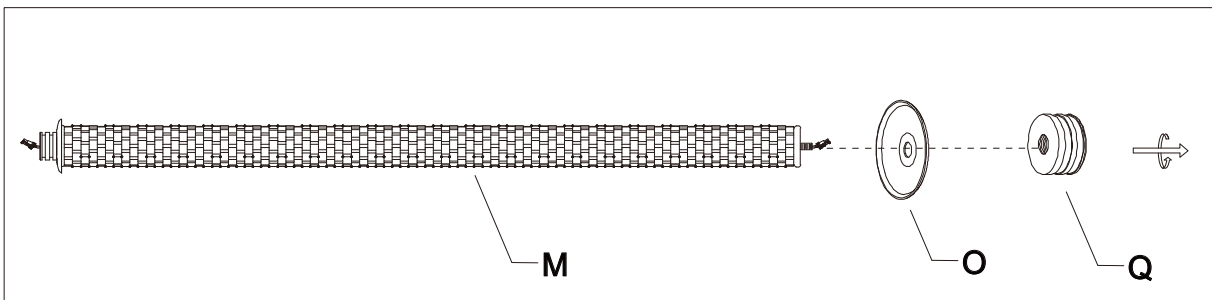

2. Place the glass (E), metal ring (B), glass (C), metal ring (B), glass (D), metal ring (B), glass (N), metal ring (B), glass (D) and tube cover (O) onto the tube (M), and then secure with the aluminum part (Q).

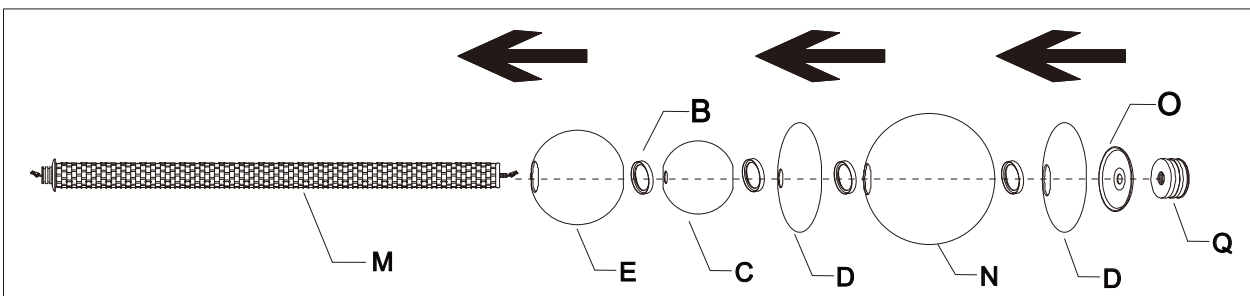

3. Please hold the end of tube (M) by hand, put the tube cover (O) and aluminum part (Q) closer to the tube (M) as much as possible, and then secure the aluminum part (Q) by inserting the screw driver (not included).

Recommendation: It is recommended to install the tube (M) with two people. Person A will hold the end of tube (M) in place, person B will place the cover (O) and aluminum part (Q) onto the tube (M), tighten the aluminum part (Q) by using the screw driver (not included) by turning clockwise. The installation of the tube (M) with 2 people is the easiest option for the installation and it helps prevent possible sagging during installation.

Important Note : Please do not over-tighten the aluminum part (Q) or it will break the glass.

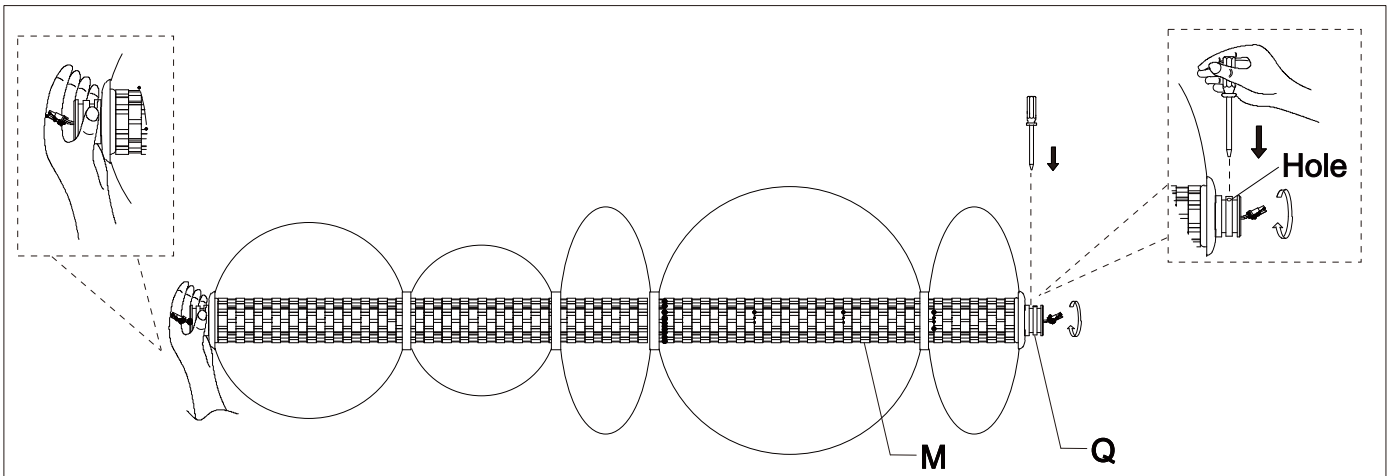

1. Wear gloves which is provided and make sure the preassembled connector box is not tangled.

Insert and pass the quick connector of the tube (A) through the connector box (R). Thread the tube (A) into the connector box (R).

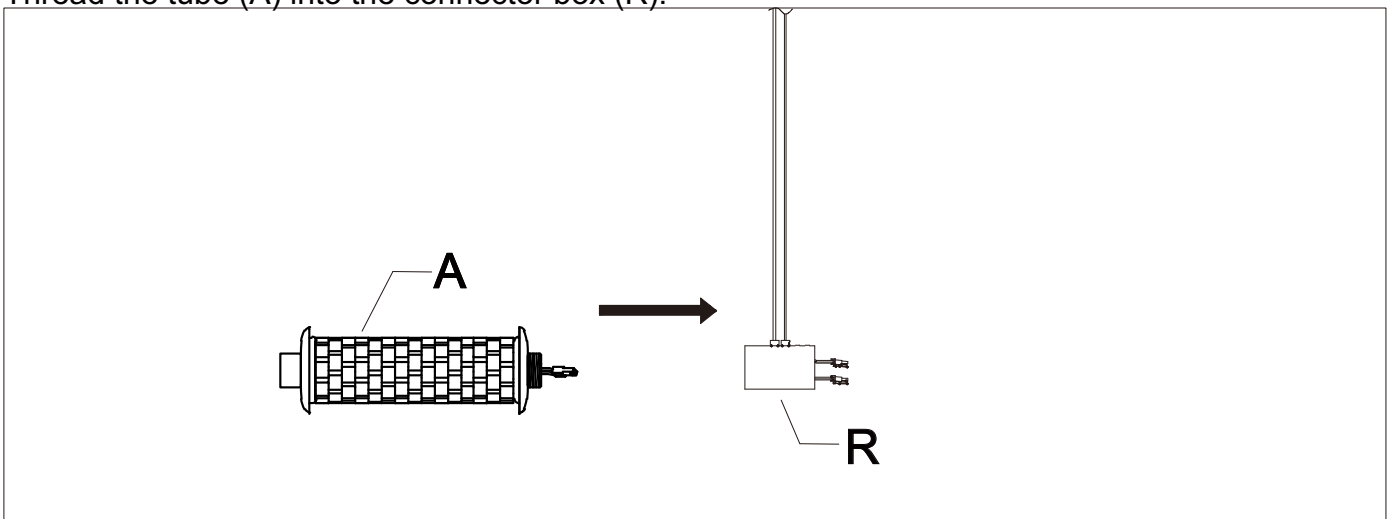

5. Connect the quick connector of the tube (A) with one of quick connector of the connector box (R). Connect the quick connector of the tube (M) with one of quick connector of the connector box (R). Tuck back the quick connectors into the connector box (R), please take care to tuck them back one by one.

 **Note: Please take care to tuck the quick connector back to connector box (R) one by one.**

 **Note: DO NOT twist the wire and connector when tuck back the quick connectors.**

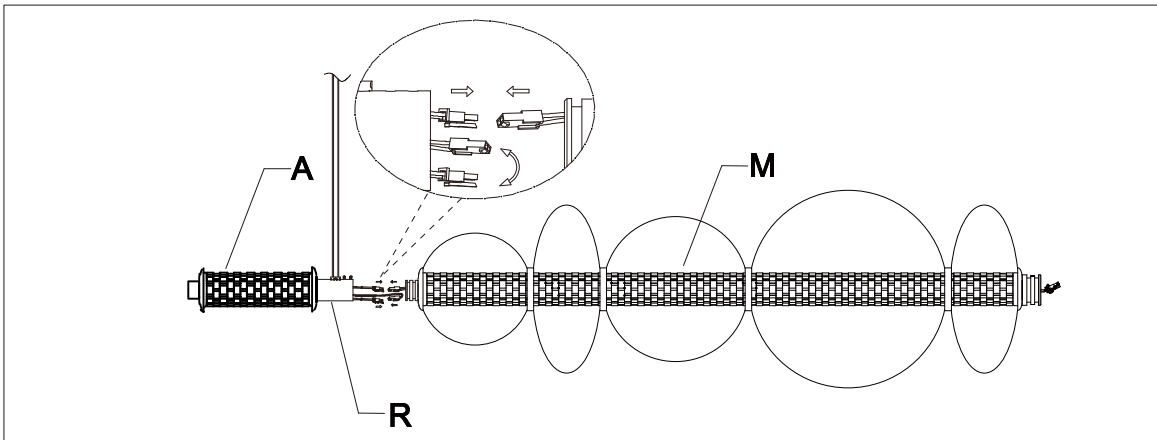

6. Unscrew the allen screws which preassembled on the connector box (R) by using the allen wrench (F).

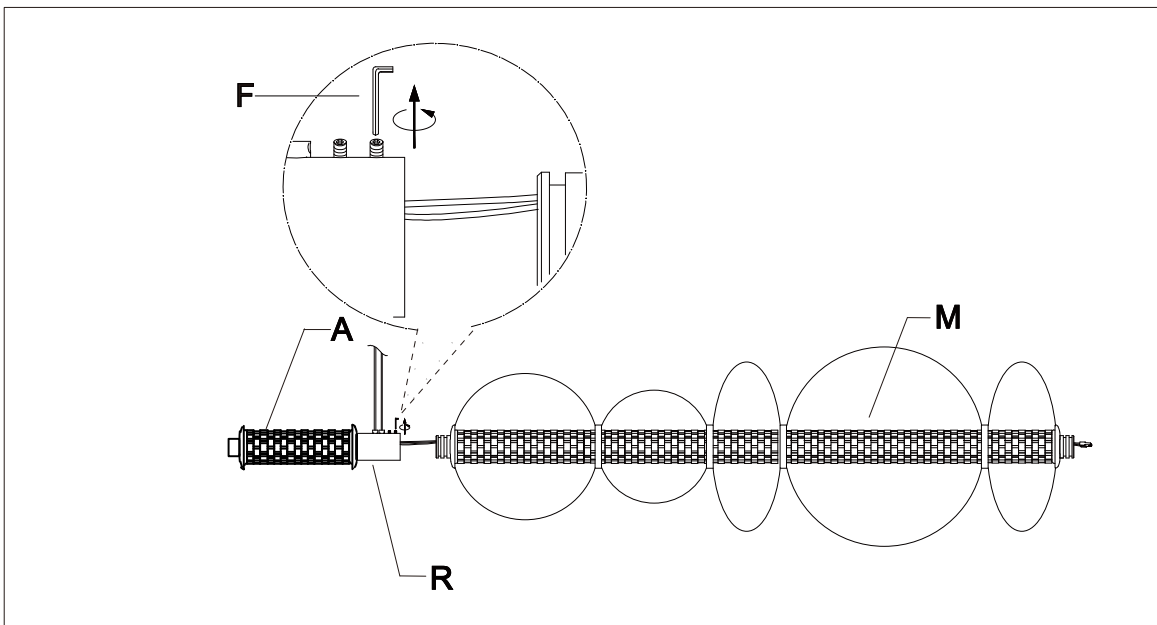

7. Insert the tube (A) into the tube (M), and then secure with the allen screws into the connector box (R) by using the allen wrench (F), take care to make its head flush with the metal surface.

Note: This step need two people to complete, one person hold the tube (A) and secure the allen screws. Another person help to hold the end of tube (M).

Note: Make sure the connector box (R) and tube (M) must fit together before locking the allen screws.

Note: Make sure the Allen wrench (F) is vertical with the connector box (R) when secure the Allen screws.

Note: Make sure the Allen screw's head is flushed with the metal surface.

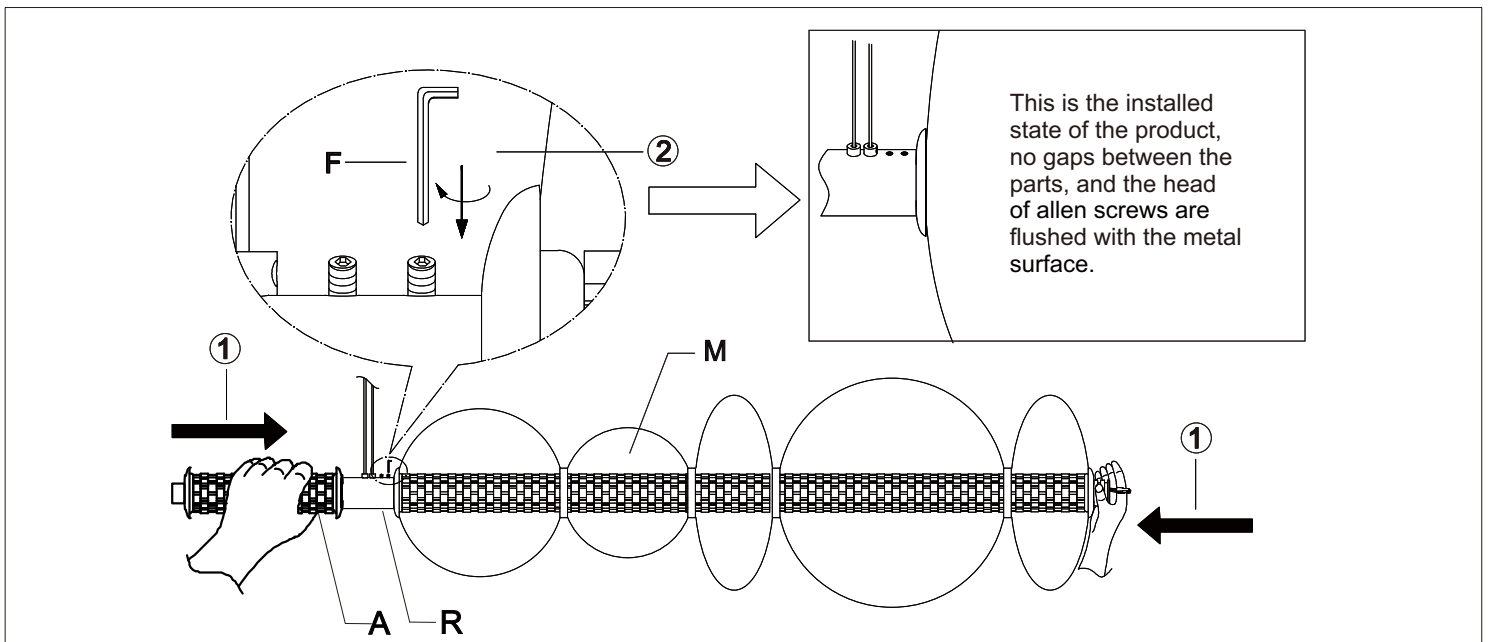
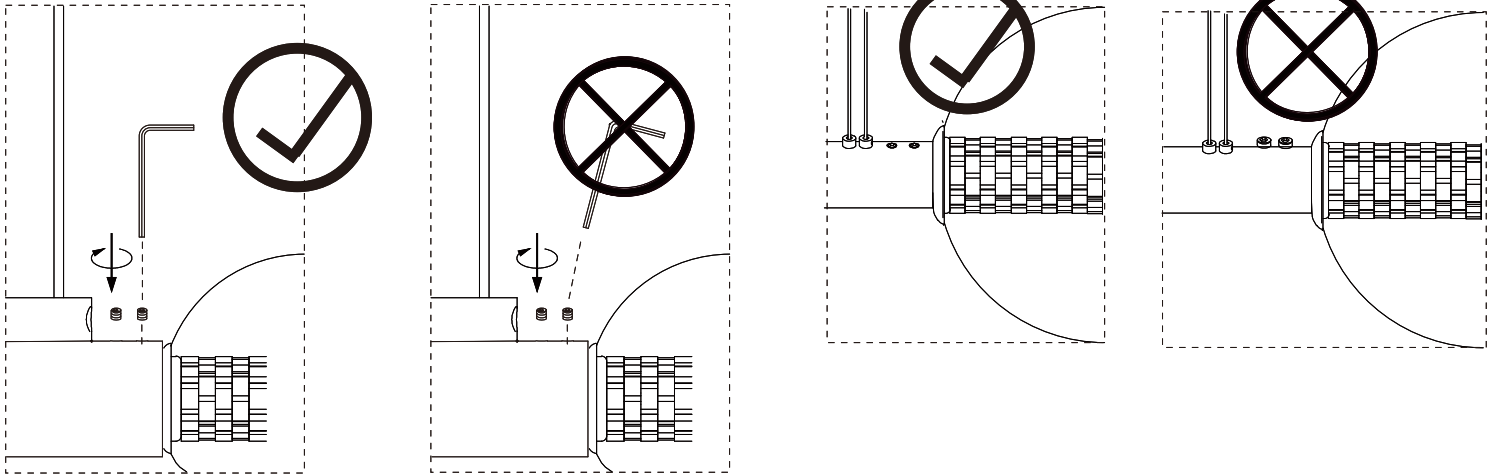

8. Repeat step# 4,5,6,7 to assemble another tube (A).

 **Note:** Please make sure that the two connector boxes (R) are aligned at the same level before fixed the Allen screws.

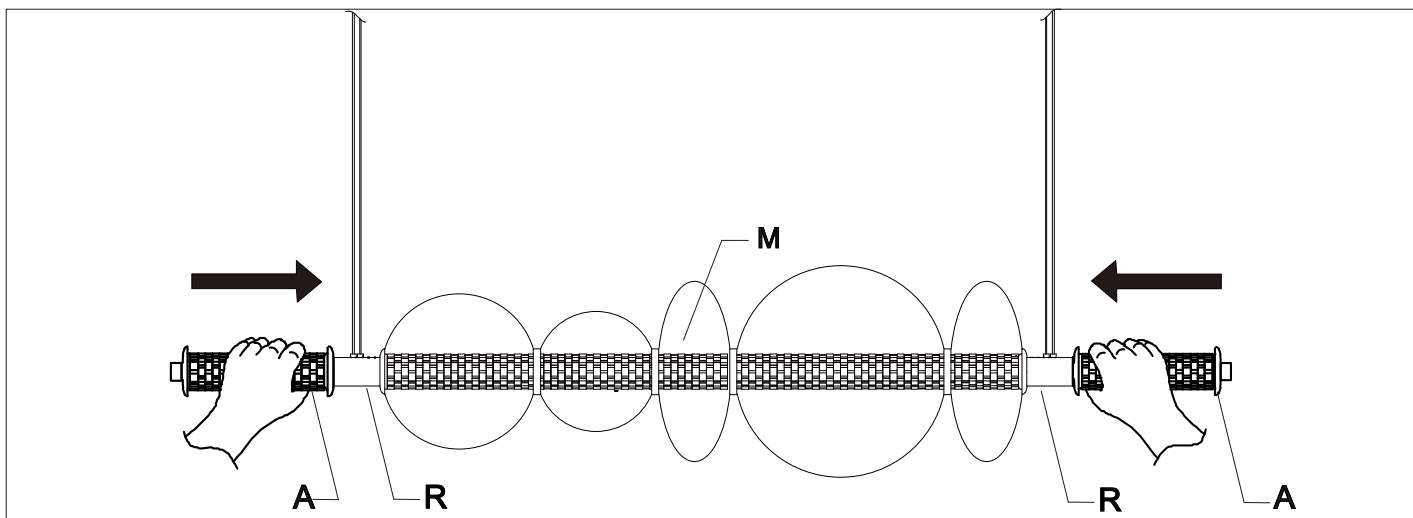

9. Unscrew the preassembled tube nut (P) and tube cover (O) from the tube (A).

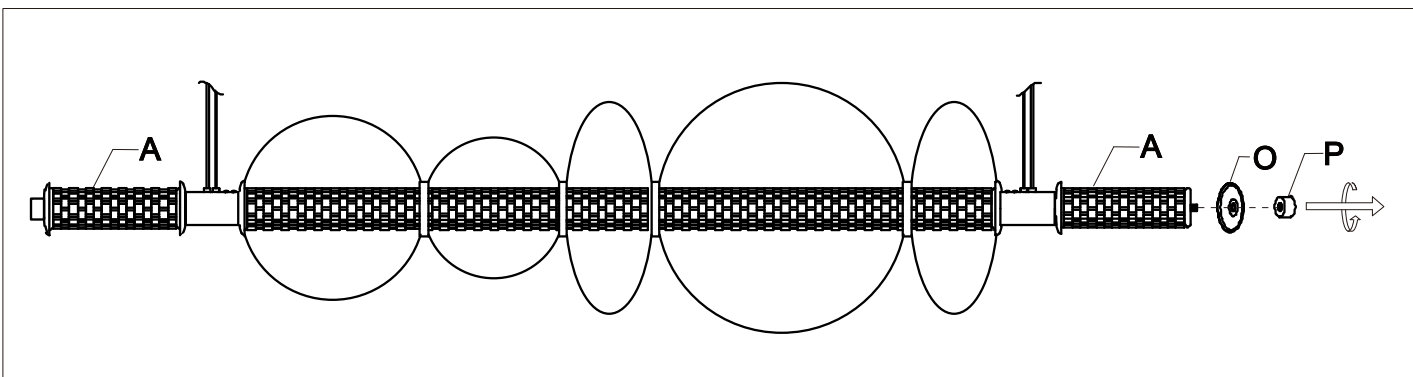

10. Place the glass (C) and tube cover (O) onto the tube (A), and then secure with the tube nut (P).

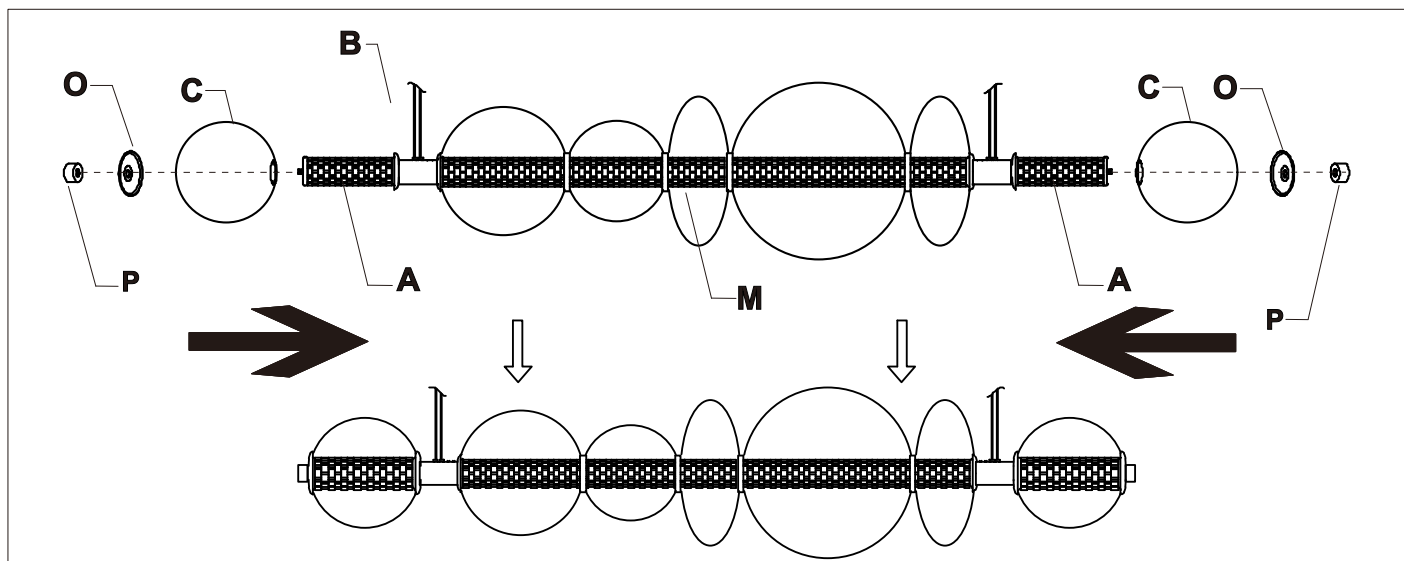

11. Unscrew the preassembled canopy nut (J) and detach the mounting plate (H).

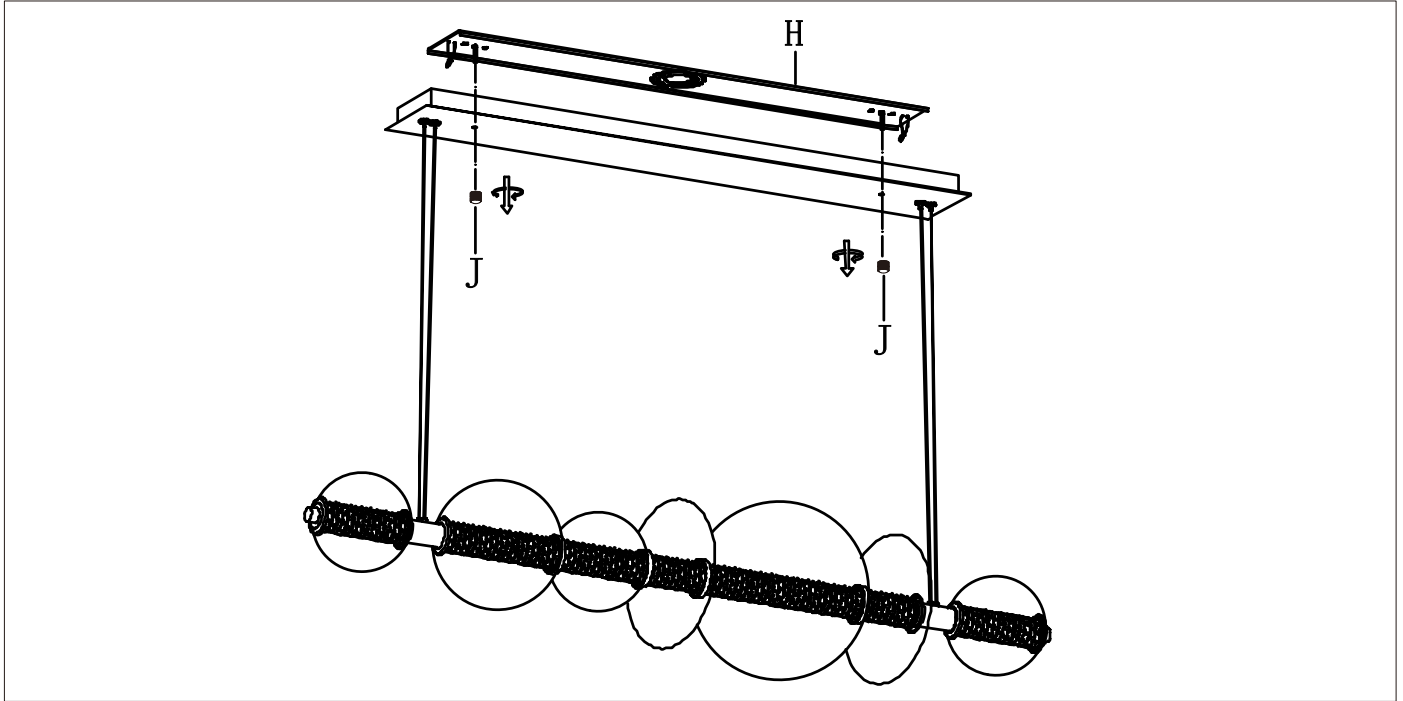

12. Temporarily secure the mounting plate (H) to the junction box (not included) with the two junction box screws (I), then mark the anchor (K) locations on the wall through the slots. Remove the mounting plate (H) and drill two holes which slightly smaller than the diameter of the anchor (K) on the wall.

Insert the anchors (K) into the wall by using the screw driver (not included) until secure.

Install the mounting plate (H) to the junction box with two junction box screws (I), thread the anchor screws (L) provided into the anchors (K).

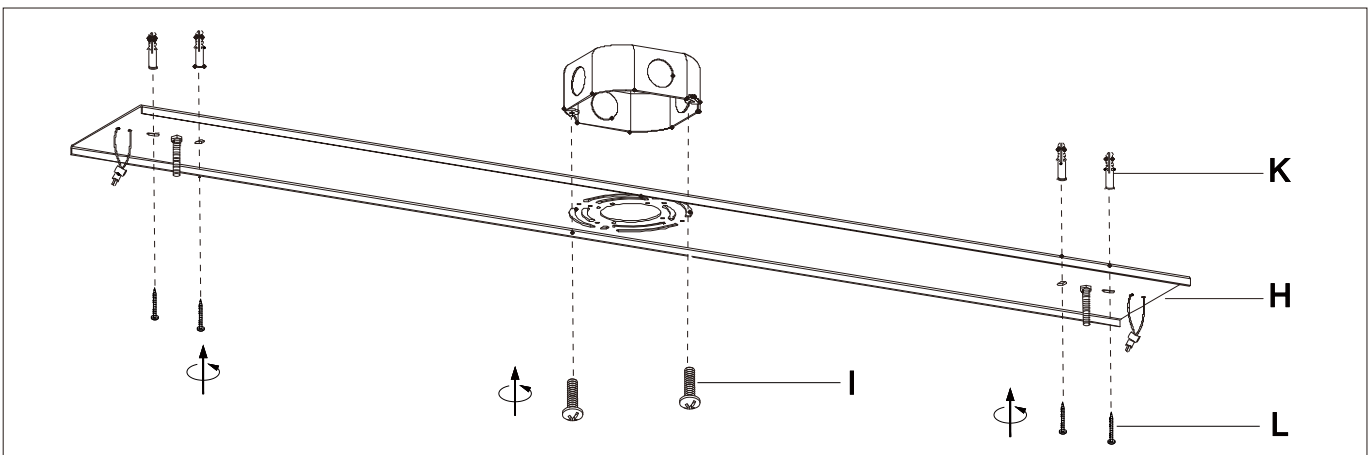

13. Attach the hang buckle from the canopy to the mounting plate (H).

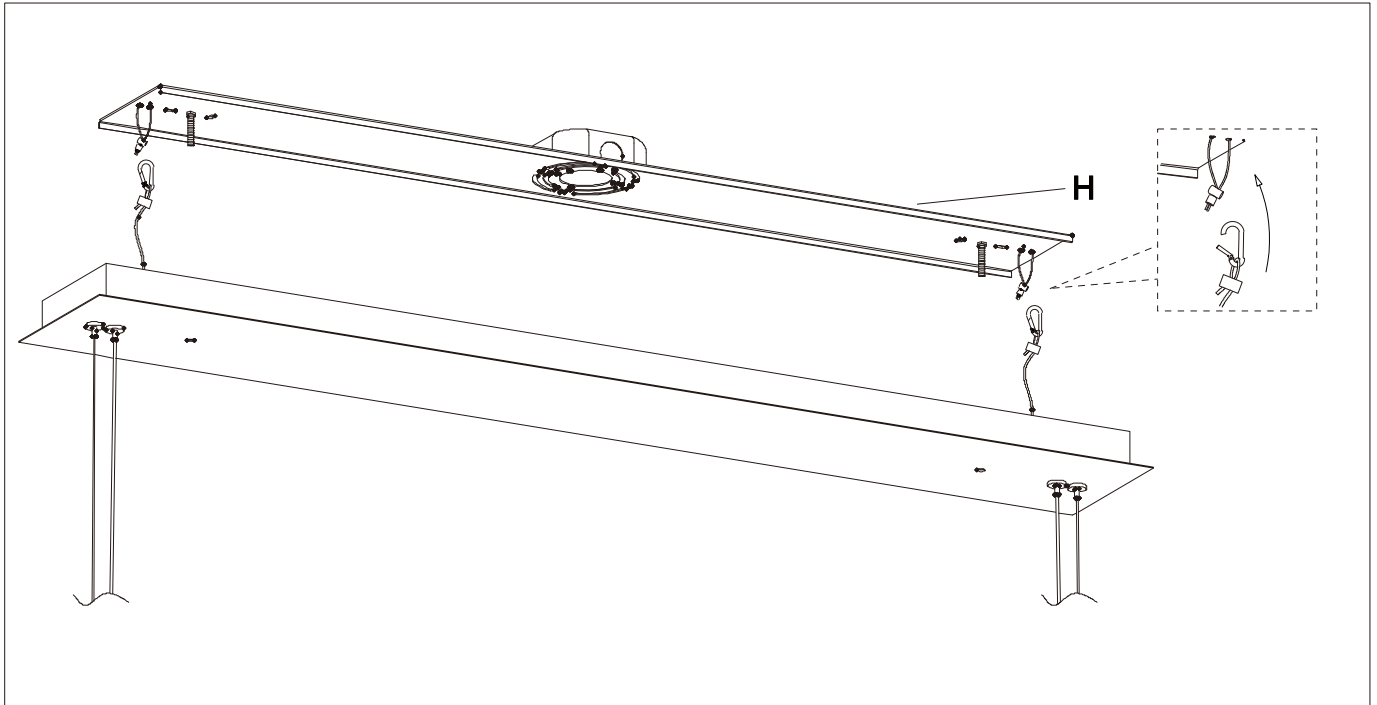

14. Connect the ground wire (green wire or bare copper wire) from the branch circuit to the green ground screw on the mounting plate (H) and then connect it to the ground wire from the fixture. Connect the fixture wires as follows and secure wire connectors with U.L./CSA Listed electrical tape (not included).

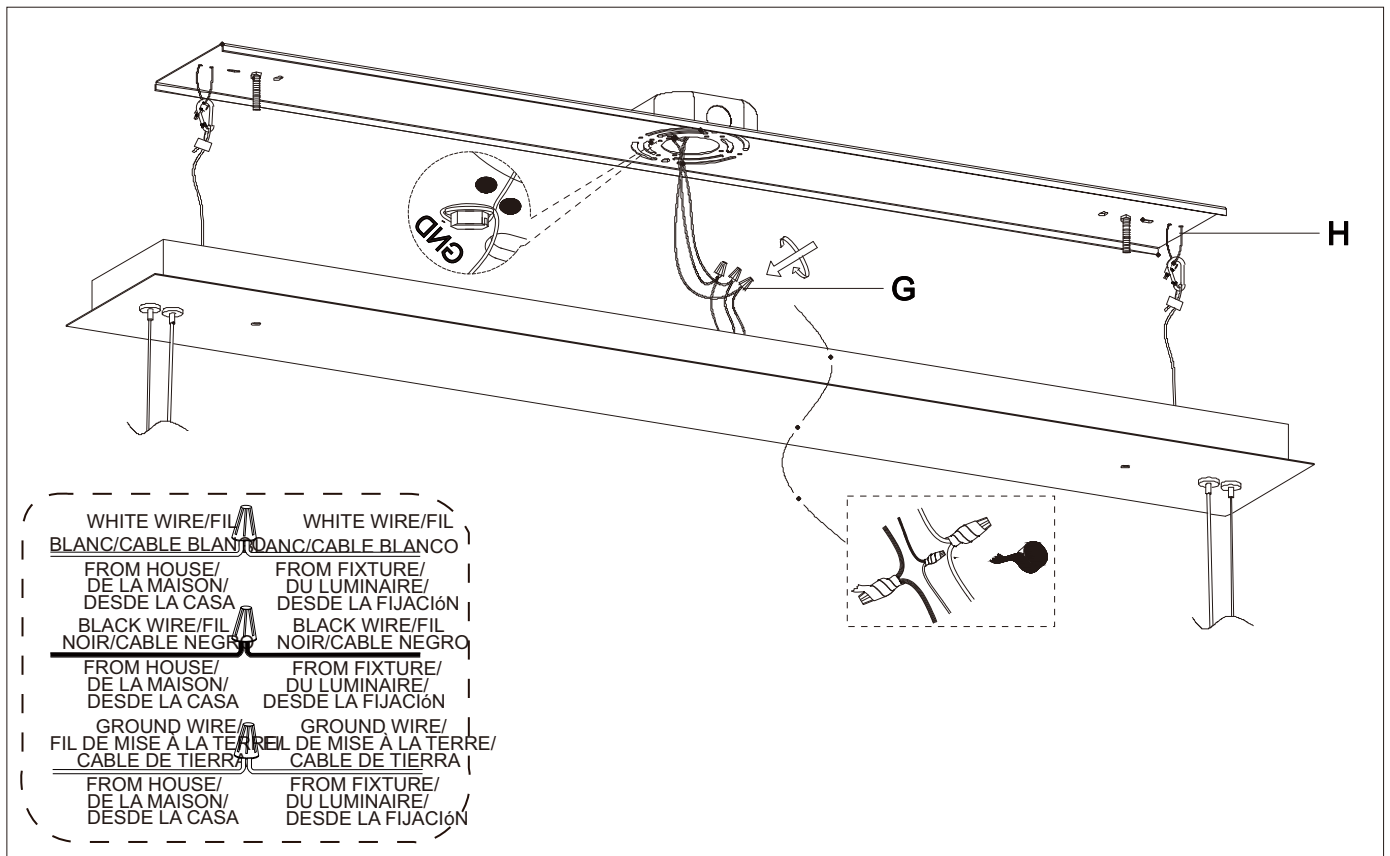

15. Place the canopy against the mounting plate (H), allowing the preassembled screws on the mounting plate (H) to pass through the canopy and secure with canopy nuts (J).

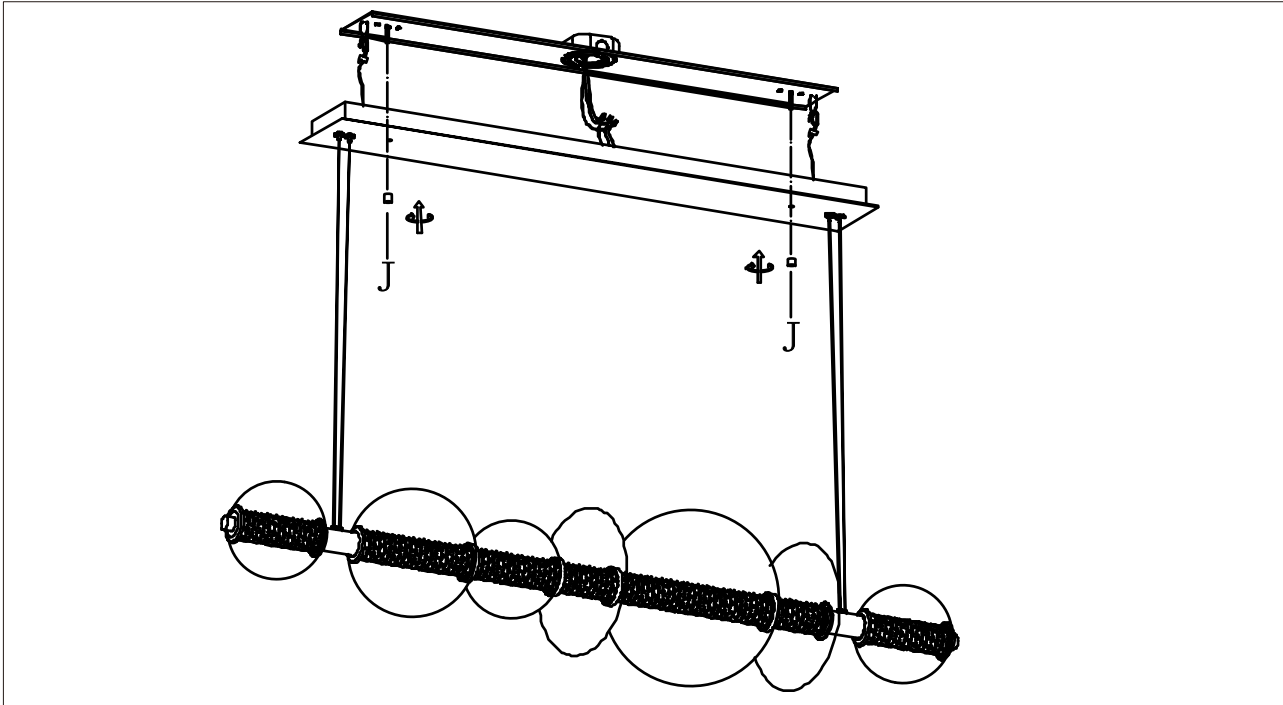

16. Determine the fixture height by adjusting the wire lock.

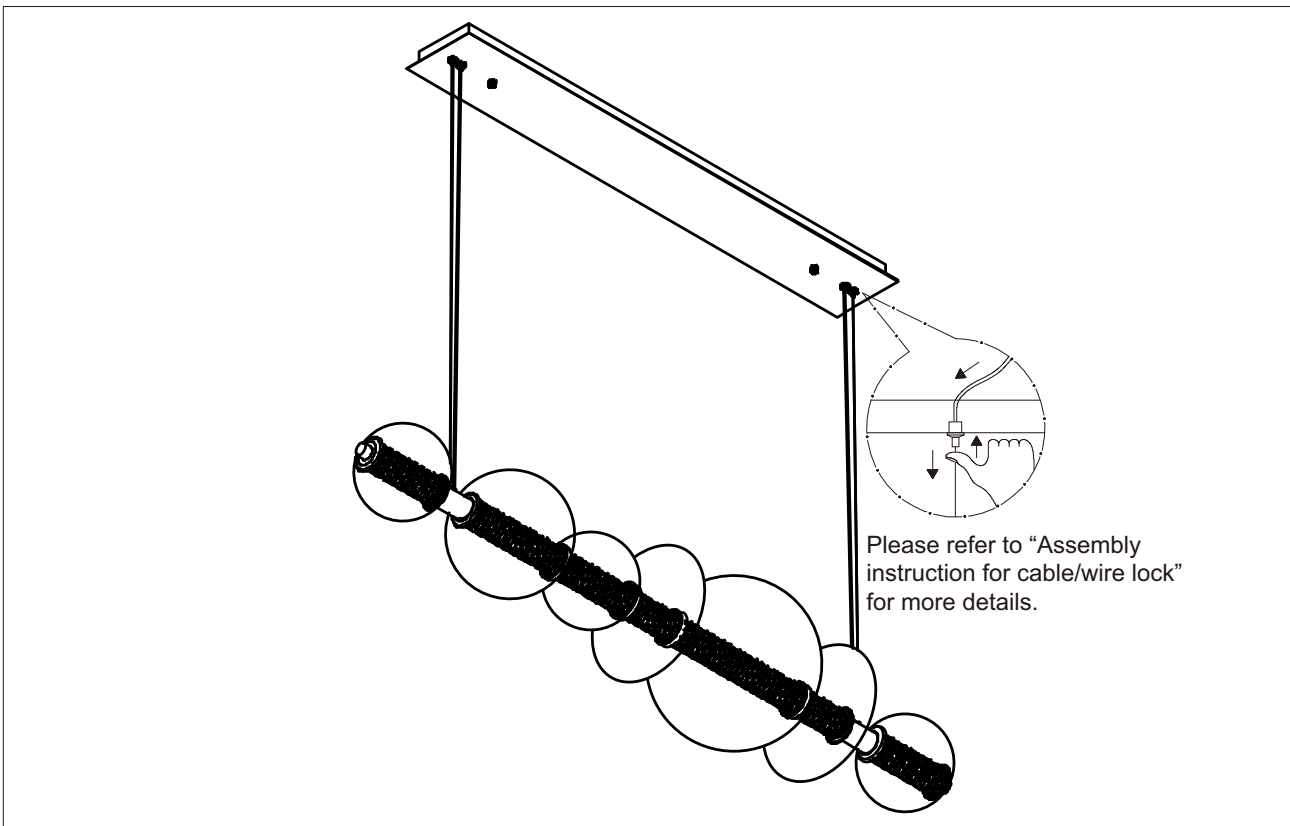

REPLACEMENT PARTS:/PIÈCES DE RECHANGE :/PIEZAS DE REPUESTO:

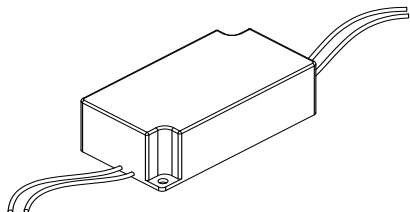

NOVBO NE024277060-2GH
Part #:49194-012

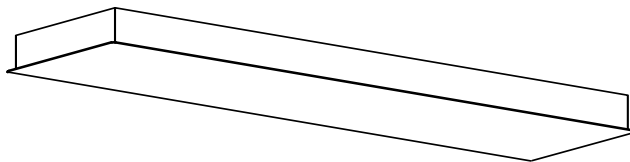

ATOMO-CNP-41IN-GD/46772/47257
Part #:45459-014
ATOMO-CNP-41IN-CHR-46772/47257
Part #:45459-021
ATOMO-CNP-41IN-BK-46772/47257
Part #:45459-030

WARNING/AVERTISSEMENT/ADVERTENCIA

In order to avoid damage of the wire lock, please follow below action to do adjustment of the cable!

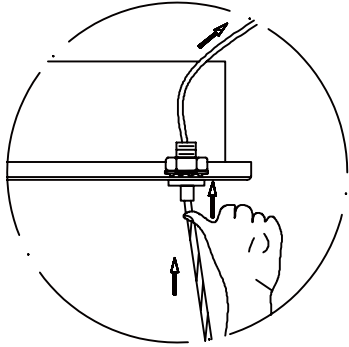

Shorten cable: Please hold down the bottom of the wire lock and slowly push or pull the cable upwards.

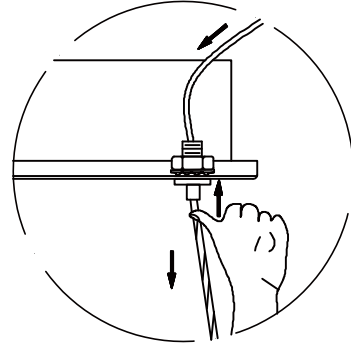

Stretching cable: Please hold down the bottom of the wire lock and slowly push or pull the cable down.

ASSEMBLY INSTRUCTION FOR CABLE/WIRE LOCK

Please follow below assembly instruction for cable/wire lock.

1. When removing the fixture from the packaging or handling it for installation, always hold the canopy and the fixture together with care. Do not apply extra force to the cables/wires or adjust the cable length.
2. Clean the jacket of the cable & wire before adjusting the length of the cable & wire.
3. When adjust the length of the cable and wire, only place the canopy in horizontal position and the internal side face to the ceiling.
4. Please do not adjust the length of cable or wire when canopy at sideway and upside-down position or orientation, or it will damage the wire locks. Pull the cable/wire from the back of canopy carefully to shorten the cable/wire, press down the cable lock and pull the cable/wire at the front of canopy carefully to lengthen the cable/wire. Do not yank the cable/wire.