

<b>PROGRAM:</b>	SOLIDWORKS
<b>UPDATED:</b>	11/19/2024
<b>SALES REV:</b>	A
<b>SIZE:</b>	A (8.5x11) (IN)

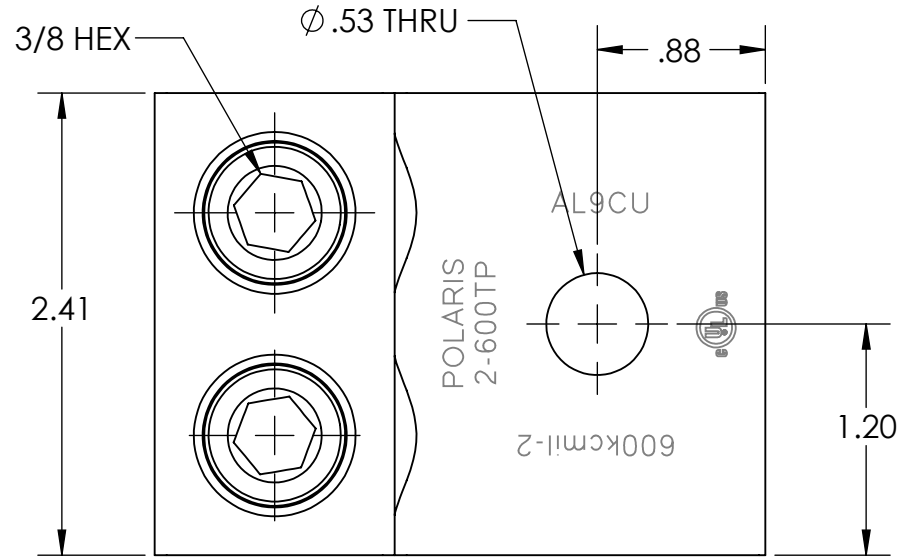

(2) 600KCMIL-2  
CONDUCTOR PORTS

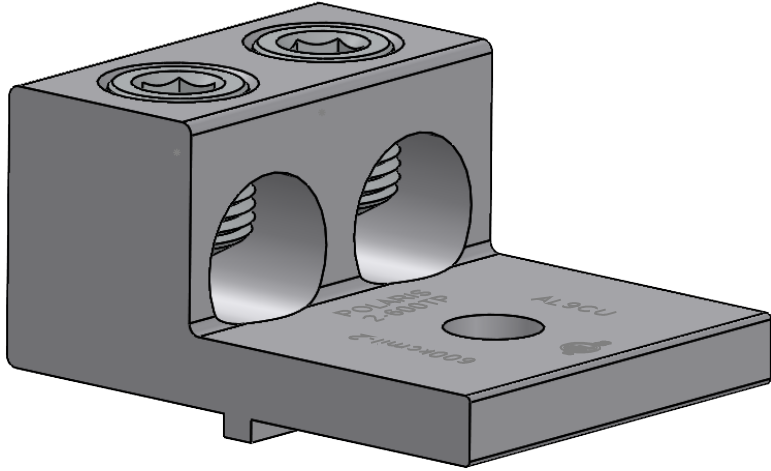
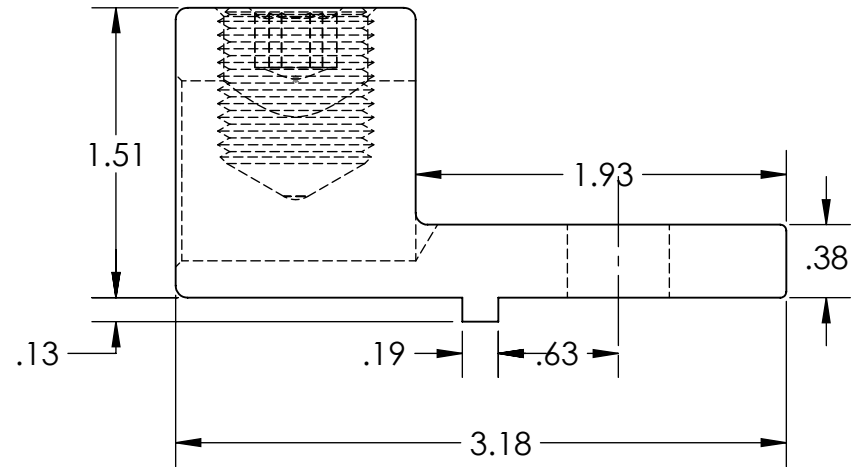
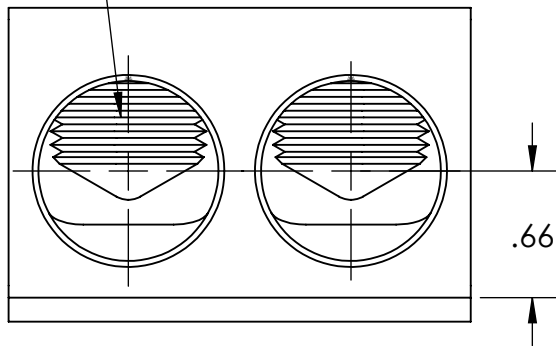

### FEATURES:

1. Material: Tin Plated Aluminum.
2. Wire connector rated for 35Kv max.
3. Class B/C compressed, concentric, and compact conductor only.
4. Dual rated AL9CU.

