

REV	ECN NO.	CHANGE CONTENT	SIGNATURE	DATE
A1		First Issued		

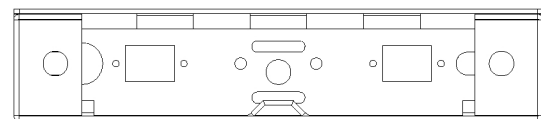

Scale 1:2

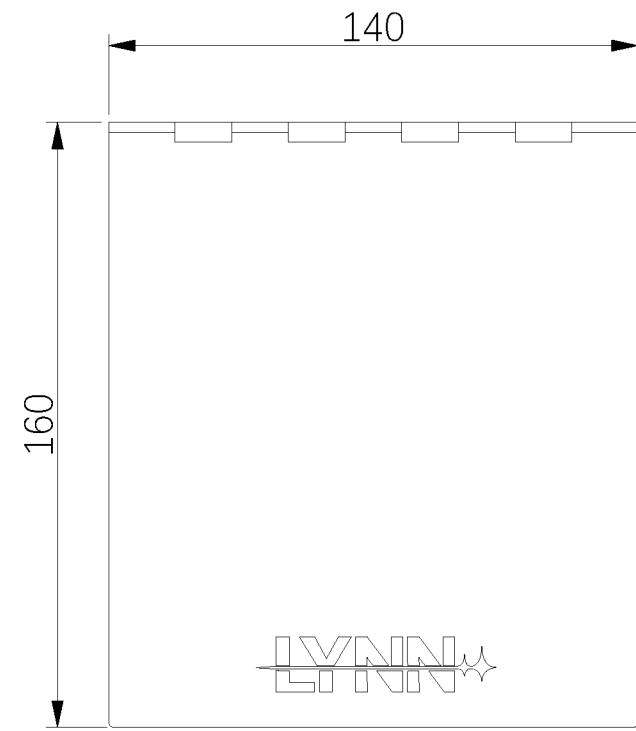
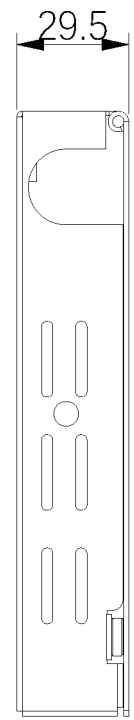
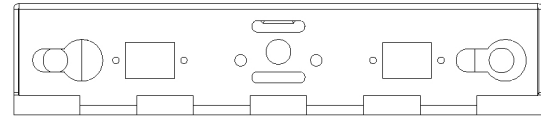
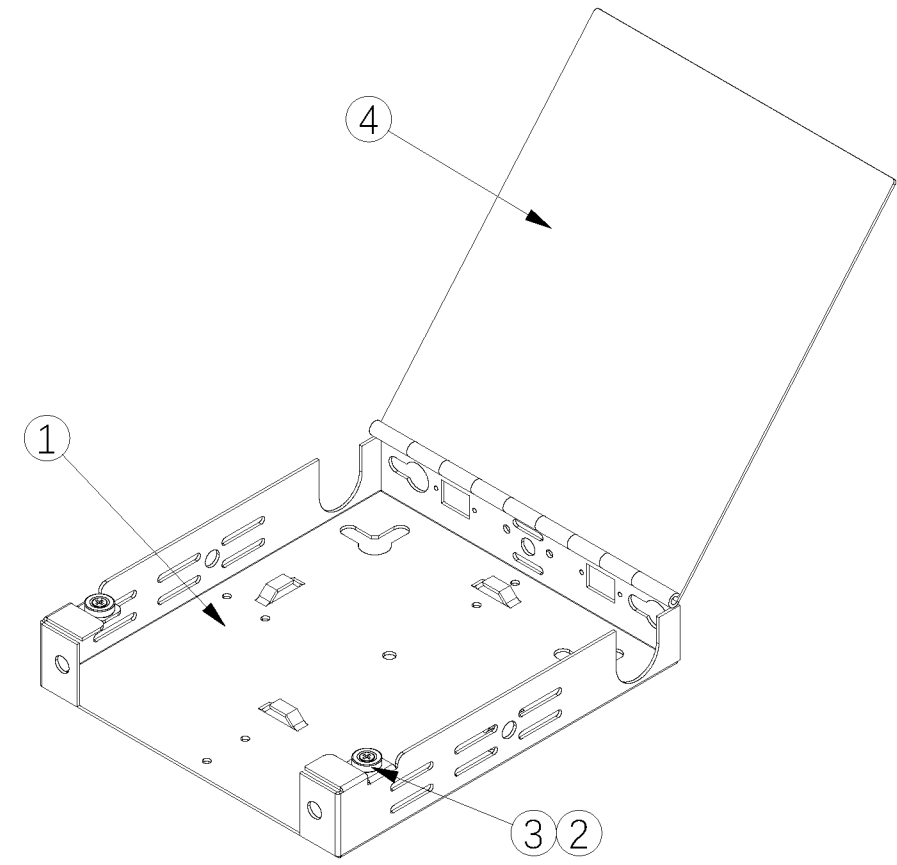

Scale 2:5

NOTE:
 1.Material:SPCC
 2.Finish:Black Powder Coat

4		A1	FPP-01-W-10-V3-12 001 Top Cap	SPCC T=1.2	1	
3	GB/T 819.2		M3X6 Screw	Steel	2	
2	CITIE		Magnet		2	
1		A1	FPP-01-W-10-V3-10 001 Bottom Case	SPCC T=1.2	1	
ITEM	DRAWING NO.	REV	DESCRIPTION	MATERIAL	QTY.	NOTE

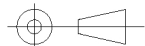
		SIGNATURE	DATE			
DRAWN			2023-02-01	MAT'L	PRODUCT NO.	FPP-01-W-10-V3
CHK'D			2023-02-01	UNITS	PRODUCT NAME	1 LGX Wall Mount Panel
PROCESS			2023-02-01	SCALE	DRAWING NO.	
APPV'D			2023-02-01	TYPE OF PROJECTION		SHEET 1 OF 1
					REV	A1