

FEATURES:

1. Material: Tin Plated Aluminum
2. UL listed for U.S. & Canada.
3. Wire connector rated for 35Kv max.
4. Class B/C compressed, concentric, and compact conductor.
5. Dual rated AL9CU.
6. Supplied with EPDM insulated cover.
7. Connector is pre-filled with oxide inhibitor.
8. Dimensions are for reference only.

PTS Series: PTS2

POLARIS®

PROGRAM:	SOLIDWORKS
UPDATED:	4/2022
SALES REV:	A
SIZE:	B (11x17)

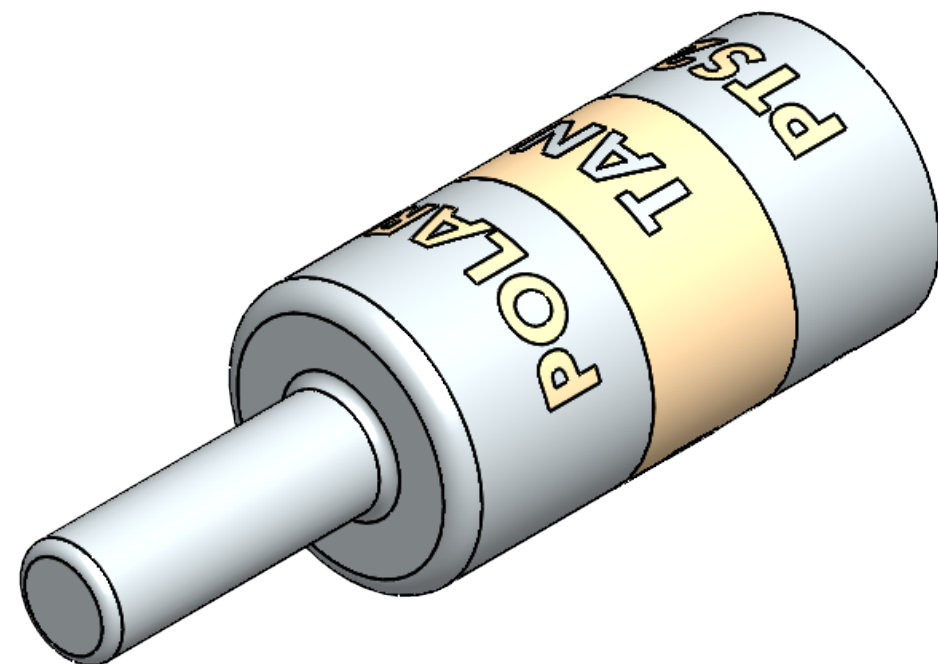

SCALE 3:1

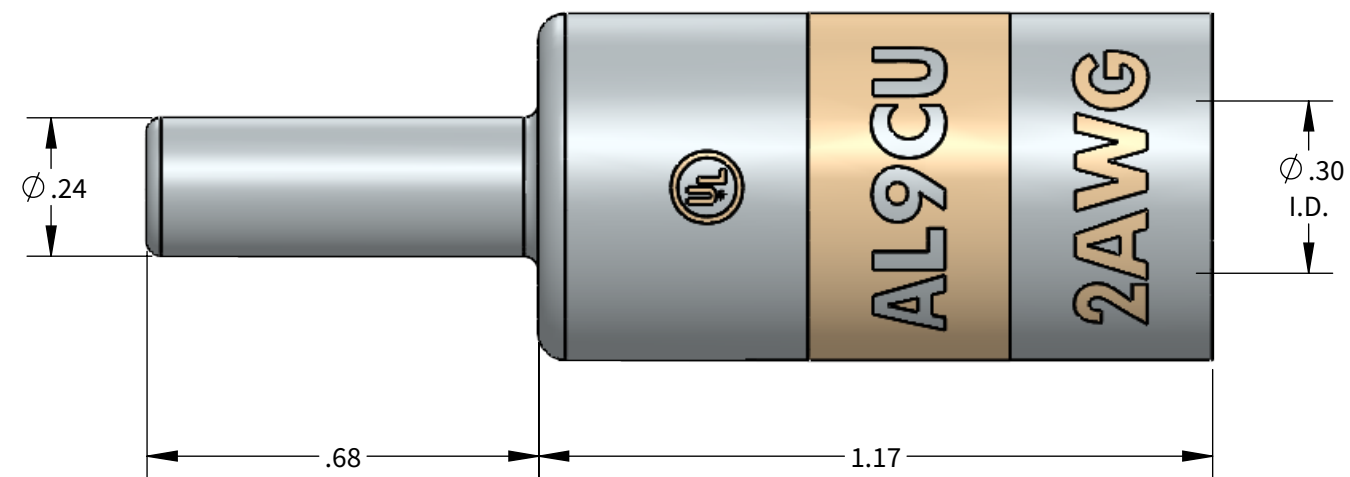
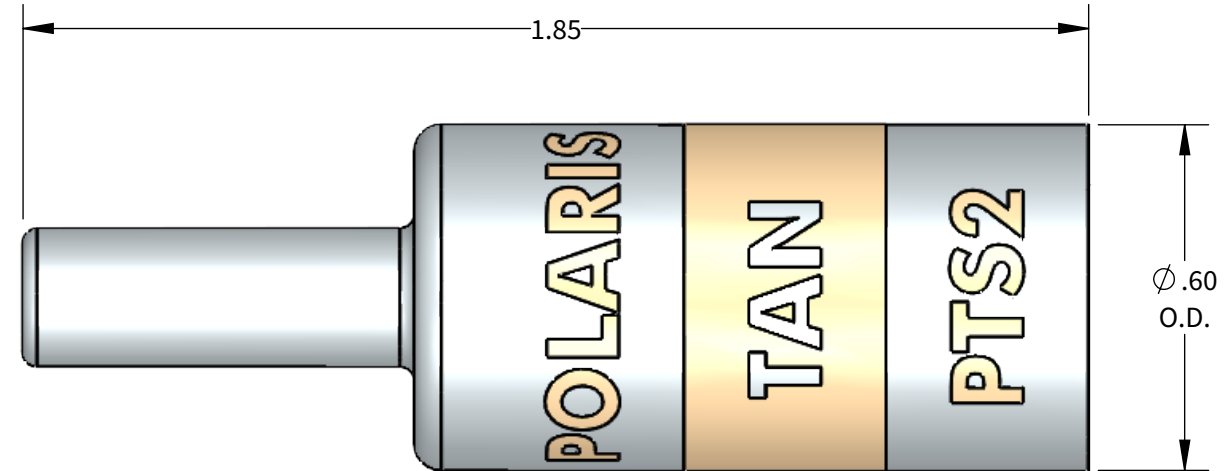

+

ALUMINUM COMPRESSION CONNECTOR TOOL AND DIE CHART
(# OF CRIMPS)

GREENLEE

N1240 SERIES

CD9(1)

WIRE SIZE	STRIP LENGTH	DIE COLOR
2AWG	1-1/8"	TAN

