

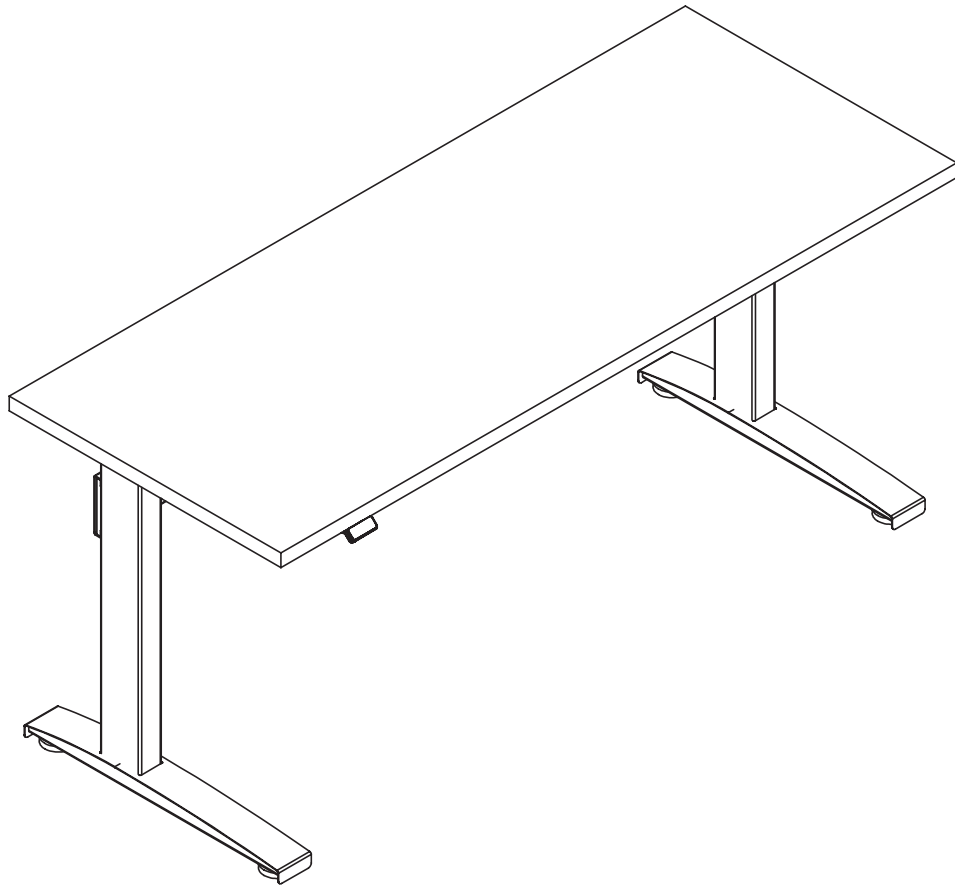

**NewHeights™ Series 4 Bonita ET Heavy Duty
2-Leg Workstation**

Warranty: raproducts.com/warranty



READ ALL INSTRUCTIONS BEFORE USING THIS PRODUCT.



**USE THIS PRODUCT ONLY AS INSTRUCTED.
FAILURE TO COMPLY WITH ALL INSTRUCTIONS AND WARNINGS
MAY RESULT IN SERIOUS PROPERTY DAMAGE OR BODILY INJURY.**

Basic Safety Instructions

- 1. Intended Use.** This Product is exclusively designed for use as indoor office furniture in compliance with all instructions and safety warnings in the user manual. Any different use, or use extending beyond the intended use, may result in property damage or bodily injury and is prohibited. This Product should not be used, operated or maintained with additional components not authorized by K&A Manufacturing, Inc.

BY USING THIS PRODUCT OR ANY FEATURE OF THIS PRODUCT, YOU AGREE TO COMPLY WITH ALL PRODUCT TERMS AND POLICIES, INCLUDING WITHOUT LIMITATION ANY SAFETY WARNINGS AND INSTRUCTIONS, PROVIDED BY K&A MANUFACTURING, INC. AND ITS AFFILIATES. K&A MANUFACTURING, INC. SHALL ASSUME NO LIABILITY FOR ANY DAMAGE OR INJURY CAUSED BY USE OF THE PRODUCT A) IN VIOLATION OF ANY SAFETY WARNINGS OR INSTRUCTIONS; B) NOT AUTHORIZED BY K&A MANUFACTURING, INC.; OR C) BY EVENTS BEYOND K&A MANUFACTURING, INC.'S CONTROL.



**DO NOT SIT, STAND OR CRAWL ON OR UNDER THE PRODUCT.
MAKE SURE NO OBSTACLES ARE IN THE PRODUCT'S PATH.
MAKE SURE ALL CORDS ARE LONG ENOUGH TO ACCOMMODATE ANY CHANGE IN HEIGHT.
DO NOT USE ATTACHMENTS NOT RECOMMENDED BY THE MANUFACTURER.**

- 2. Electrical Height Adjustment.** The height of this Product may be adjusted electronically. Contact with electrical voltage may cause serious injury and death. Only use the Product in compliance with these instructions. This Product should not be used in environments with high levels of humidity or moisture.

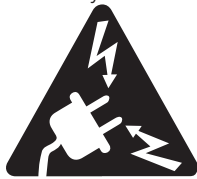

**KEEP CORDS AND ELECTRICAL COMPONENTS AWAY FROM HEAT AND LIQUIDS.
DO NOT OPEN ANY OF THE COMPONENTS: CONTROL BOX OR KEYPAD.
DO NOT USE WITH A DAMAGED PLUG OR CORD.
DO NOT INSERT ANYTHING INTO ANY SEAM OR OPENING.**

- 3. Setup and Use.** This Product should only be used and operated in good condition. When in use, no one should sit, stand or crawl on or under the Product. There is a danger of crushing, shearing, injury or damage. Keep the entire range of motion of the Product clear of all obstacles. Devices and object on the Product can tip over, fall or be crushed by the Product.



**KEEP HANDS AND FINGERS CLEAR.
KEEP ALL OBSTACLES CLEAR OF THE PRODUCT'S PATH.**

- 4. Users.** This Product is not intended for use with children, individuals with restricted physical, sensory or mental capabilities, or individuals who lack experience or knowledge, unless they are supervised by a person who is responsible for their safety or they have received instructions from a person who is responsible for their safety concerning how the Product must be used. Children should be closely supervised to ensure that they do not play with the Product and its height adjustment mechanism to avoid risk of physical injury or electric shock.



KEEP CHILDREN AWAY FROM THE PRODUCT, ITS CONTROL UNITS, AND KEYPADS.

Tools Required for Assembly

- A. Power Driver with Adjustable Torque
- B. Tape Measure
- C. #2 Phillips Head Driver Bit
- D. #2 Square Head Drive Bit (**Recommended**)

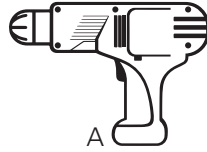

Hardware and Tools Included for Assembly (may have extra)

- E. 5/8" Washer Head Wood Screw *x42*
- F. 1/4"x 5/8" Bolt *x4*
- G. Lock Washer *x4*
- H. 5/8" Wood Screw *x4*
- I. Cord Clip *x1*
- J. M6 x 10mm Bolt *x4*
- K. Star Washer *x4*
- L. Wire Management Channel *x1*
- M. 3/16" Allen Wrench *x1*
- N. 4mm Allen Wrench *x1*
- O. 6mm Hex Rod Wrench *x1*

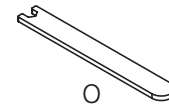
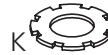
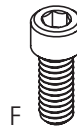

Bonita Parts

- P. Cross Support *x1*
- Q. U-Channel *x1*
- R. Short Hex Rod *x2*
- S. Switch *x1*
- T. Control Box *x1*
- U. Power Cord *x1*
- V. Left Motor *x1*
- W. Right Motor *x1*
- X. Left Leg *x1*
- Y. Right Leg *x1*

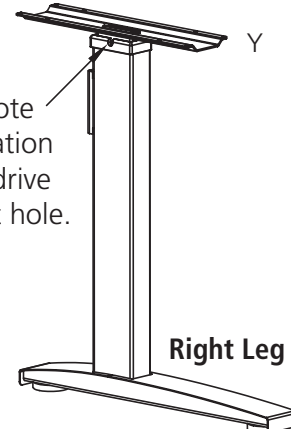
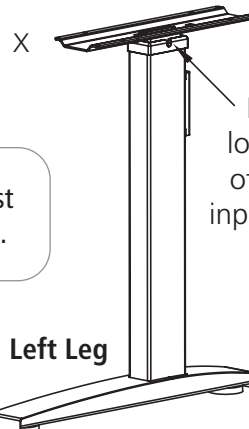
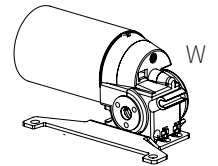
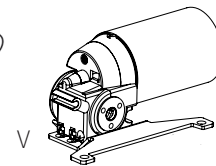
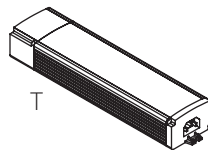
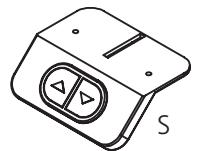
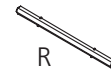
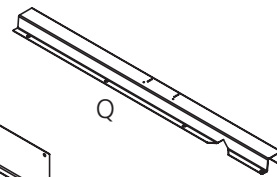
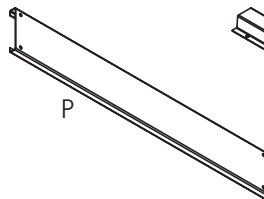

Legs must be in their lowest position before installation.

Note location of drive input hole.

Step 1



Lay the worksurface on a protected surface with pilot holes facing up.

LEGS MUST BE IN LOWEST POSITION BEFORE INSTALLING HEX RODS.

- Place the **left leg column (X)** onto the worksurface and align with predrilled pilot holes. Make sure leg is in its lowest position.
- Insert the short hex rod (R) through the **left motor assembly (V)** (insert starting at bracket side of the motor).
- Slide hex rod into left leg drive input hole. Hex rod should slide all the way into leg.
- If hex rod is not properly aligned with drive input, slightly rotate the motor 1/6th or 1/3rd of a turn.

PRO TIP

Hex Rod Wrench (O) can also be used to rotate hex rod

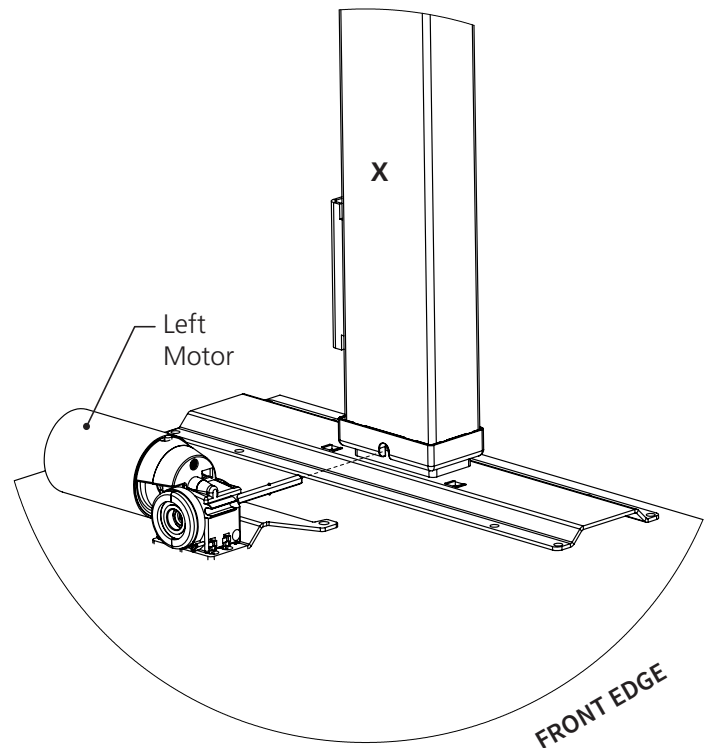
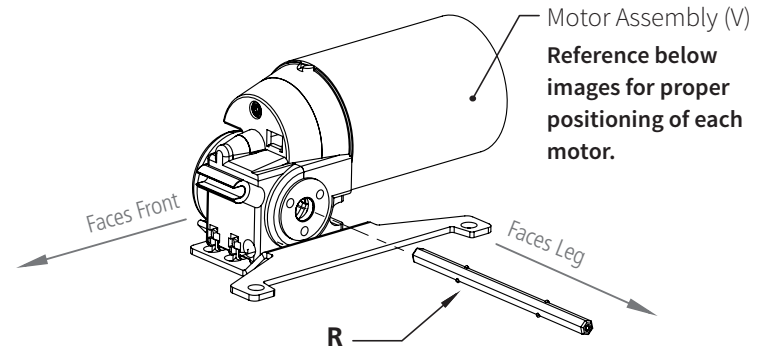
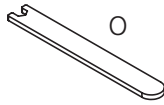

Step 2

- Place the **right leg column (Y)** onto the worksurface and align with predrilled pilot holes. Make sure leg is in its lowest position.
- Insert the short hex rod (R) through the **right motor assembly (W)** (insert starting at bracket side of the motor).
- Slide hex rod into right leg drive input hole. Hex rod should slide all the way into leg.
- If hex rod is not properly aligned with drive input, slightly rotate the motor 1/6th or 1/3rd of a turn.

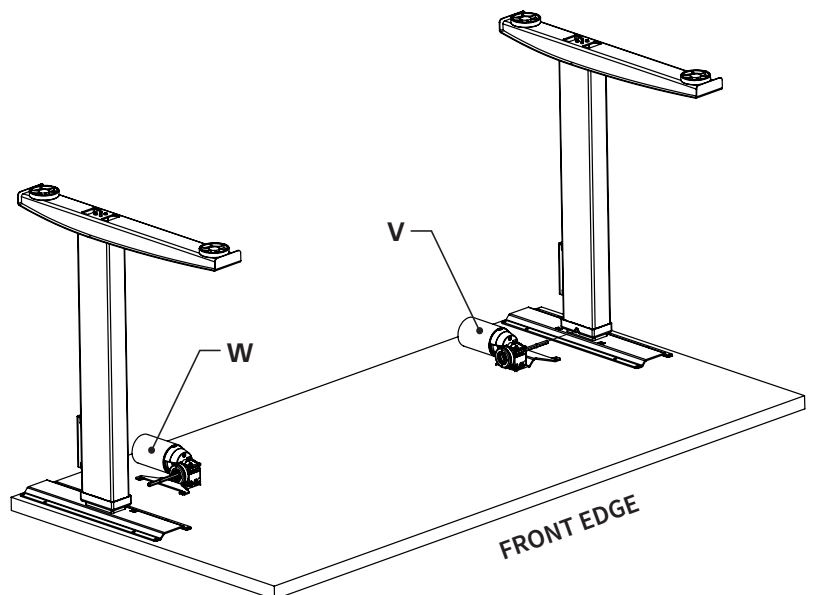

Step 3

Important: Please be aware that 5/8" screws are provided. If your worksurface is 5/8" or thinner, you will need to supply your own hardware.

- After hex rod is installed, align motor brackets and corresponding mounting holes on each leg column.
- Position lock washers (G) and tighten motor mounting bolts (F).

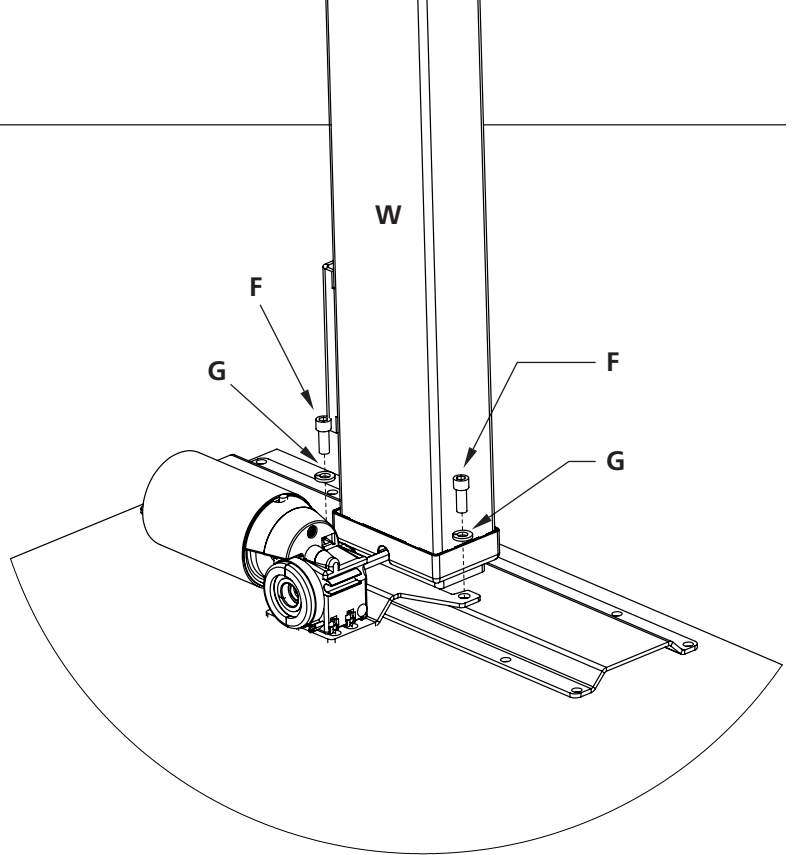
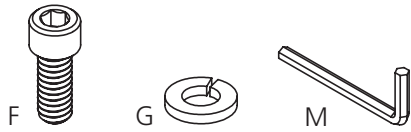

Step 4

- Align the U-channel (Q) with the pre-drilled pilot holes*.
- Make sure the end with the holes closest the edge faces towards the left motor.
- Attach U-channel to worksurface with washer head wood screws (E).
- **Do NOT fully tighten** until all screws are installed.

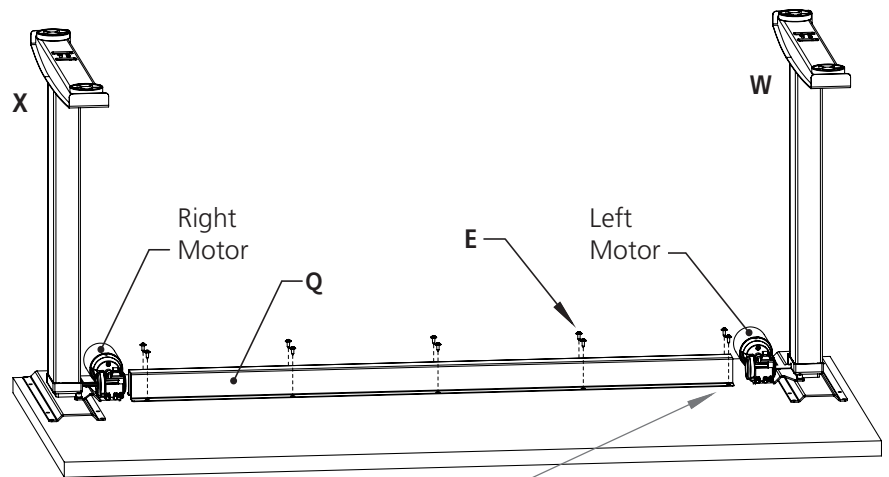
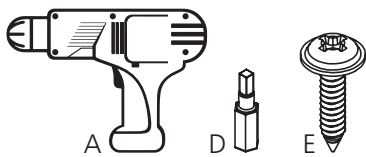

! Holes closest to end of U-channel face left motor.

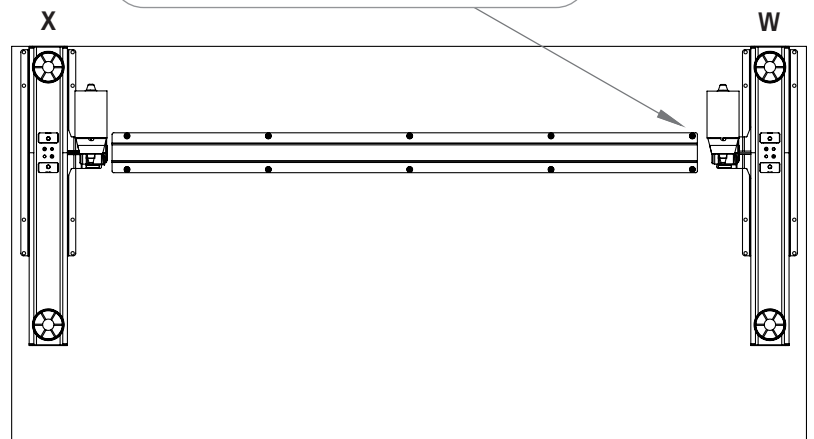

PRO TIP

For proper alignment of pre-drilled holes, first insert screws at the four corners of the U-channel. Then, install the remaining screws.

*Hole placement may vary depending on table width.

Step 5

- Slide cross support (P) over leg cross support brackets.

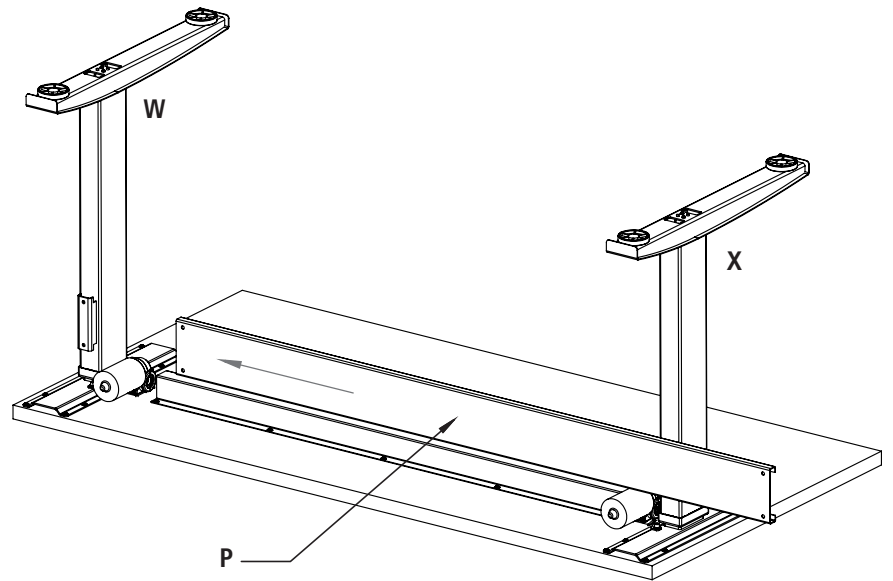

Step 6

- Install bolts and washers (4 sets).
Do NOT fully tighten.

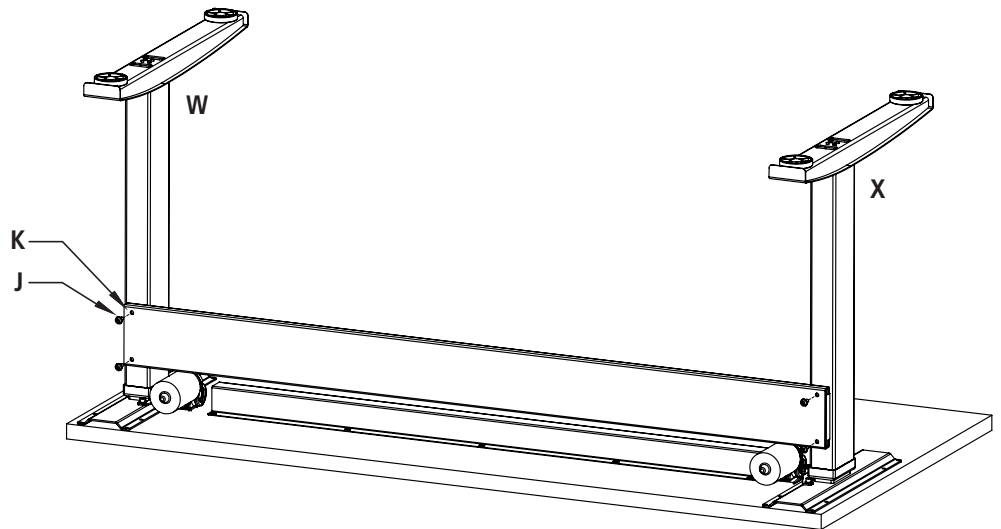
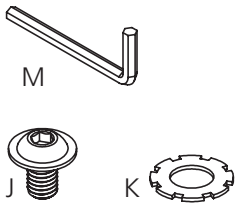

Step 7

- Align assembled base with the pre-drilled pilot holes.
- Secure the base to the worksurface with washer head wood screws (E).
- **Do NOT fully tighten** until all wood screws are inserted.

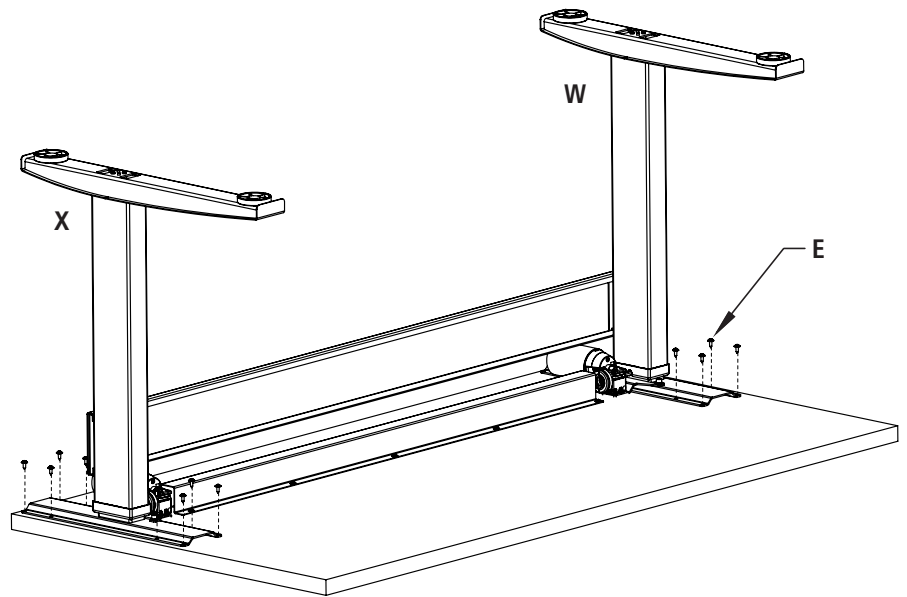
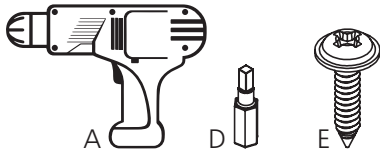

PRO TIP

For proper alignment, first insert screws at the four corners of each leg mounting bracket. Then, install remaining screws.

Step 8

- Fully tighten bolts in cross support.

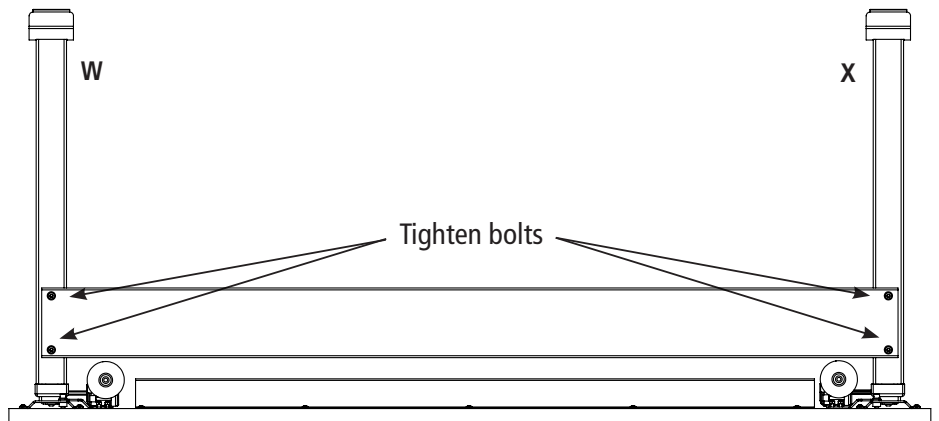

Step 9

- Mount control switch (S) to worksurface using two wood screws (H).
- For standard install location, align switch with pre-drilled pilot holes.

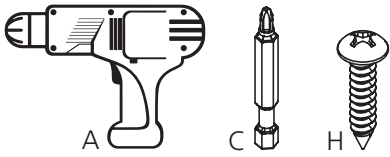

Standard Switch

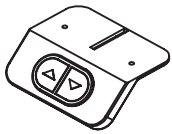

Upgrade - Programmable Switch

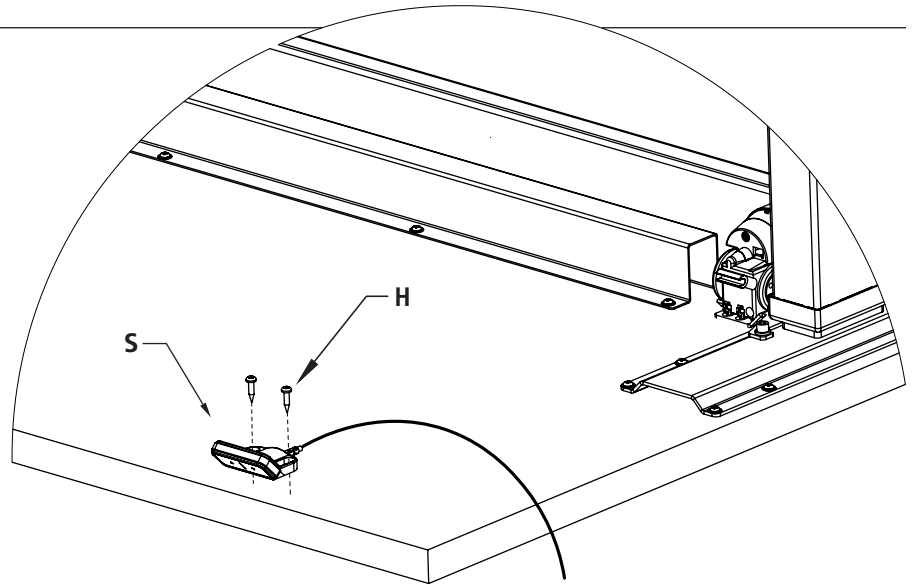
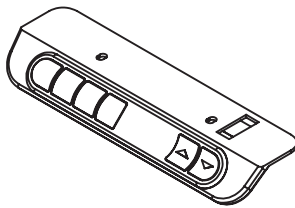

NOTE: If you have a 4-button programmable switch, please refer to the installation instructions included with switch.

Step 10

- Mount control box (T) to worksurface using two wood screws (H).
- For standard install location, align control box with pre-drilled pilot holes. However, it can be installed in any location, wire lengths permitting.



Required Orientation:

Long side of control box must run parallel to the long side of the worksurface.

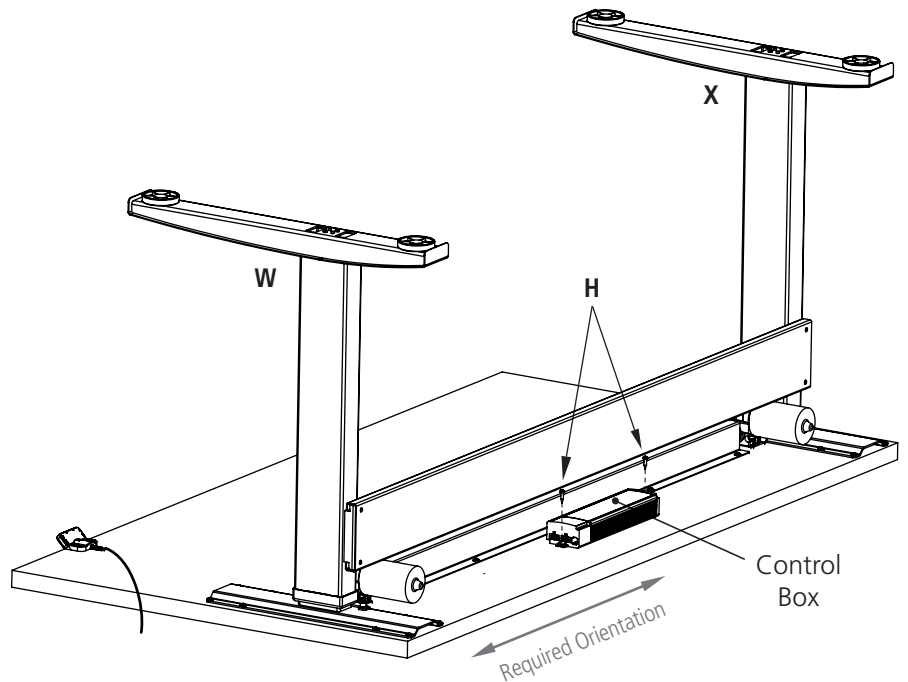
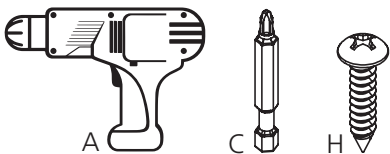

NOTE: Table will **NOT** operate unless the control box (T) is screwed tight into the table without any play.

Step 11

- Install wire management (L) and cord clip (I) to organize the cords and cables with washer head wood screws (E).
- Pilot holes are not provided.
- See **cable mounting diagram** on next page for help.

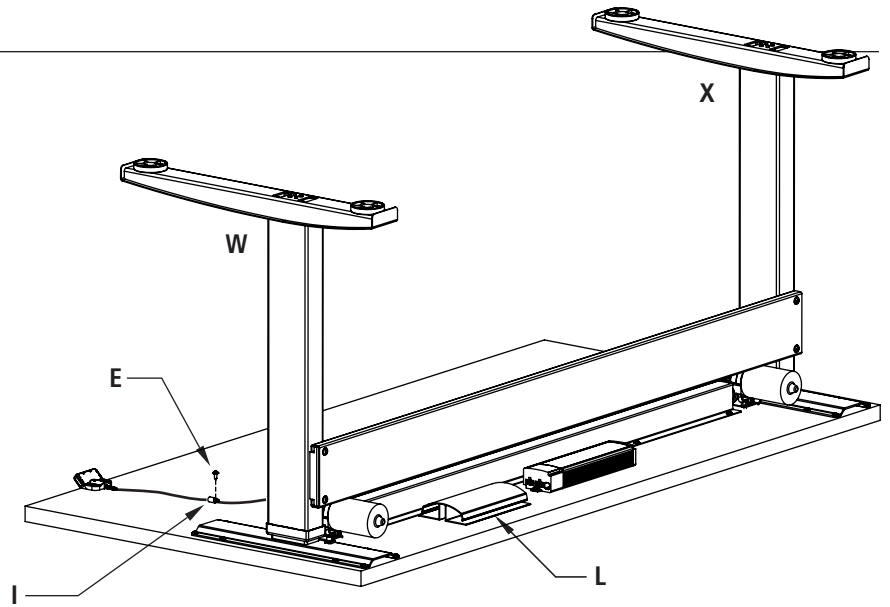
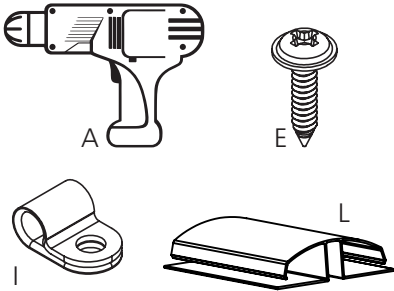

Mount the wire management channel (L) with adhesive strips AND two wood screws (E). Insert one screw on flat edge of each side of the wire management channel to penetrate plastic and worksurface.

Step 12

- Plug the control switch, motor, and power cables into the control box (T).
- Plug power cable into outlet.
- With the desk still upside down, test your Bonita to check if assembly was successful.
 - Hold the down arrow on the control switch until desk no longer moves to complete "reset mode."
 - Once table is in lowest position, push up arrow.
 - If the desk legs move properly, installation was a success. Now, you can flip desk right-side up and begin use.

Control Box End View

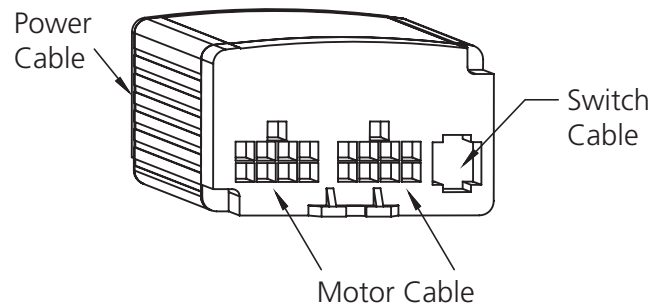

Have accessories to add? Install them while before you flip your Bonita right-side up to make the process easier.

Cable Routing Diagram

*For tables 48" or smaller, the wire management can be moved.

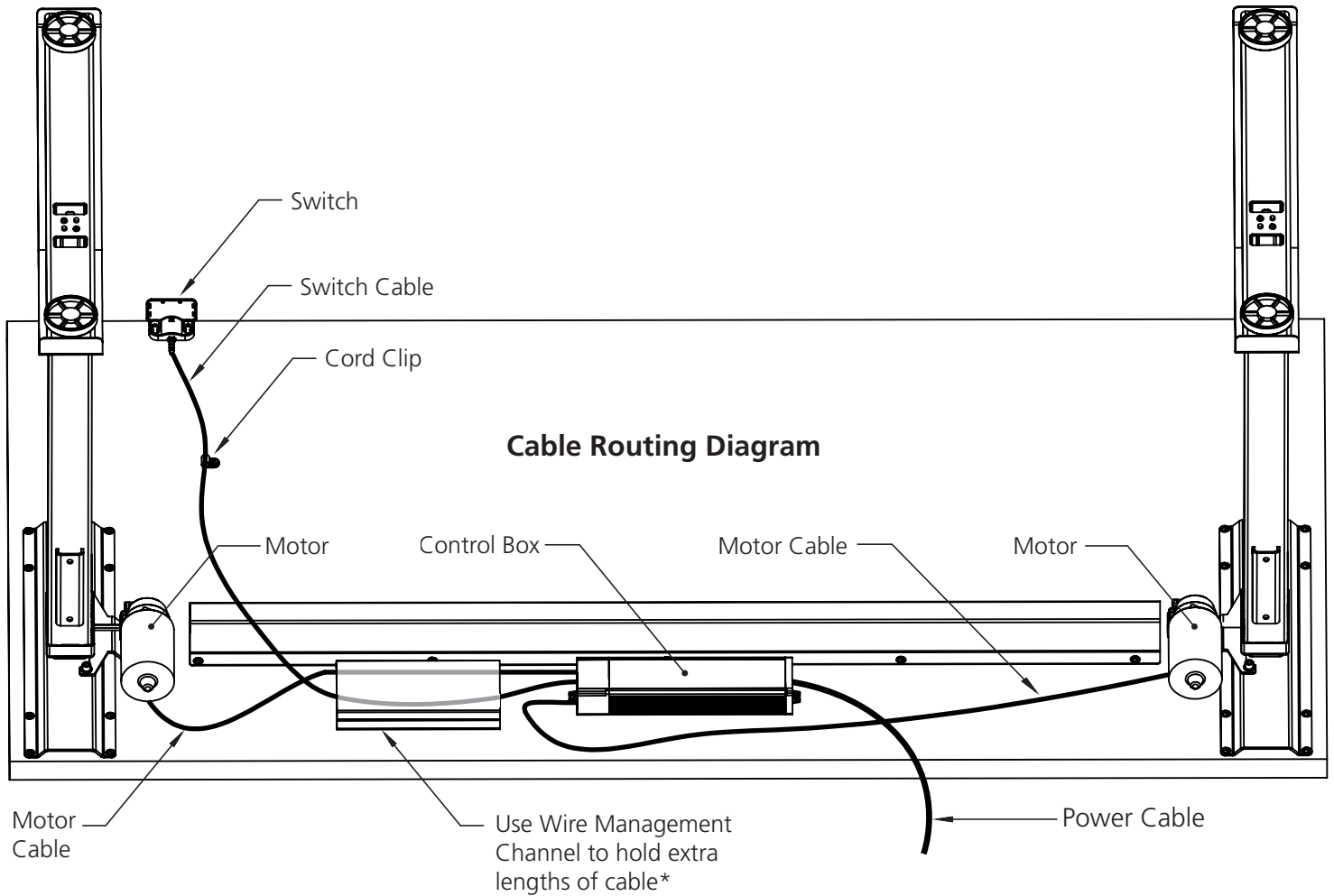

Caution:



For the safety of the user and the workstation; the control box contains an internal sensor that is sensitive to movement, vibration, and collision. For faultless operation, ensure all cables, electronics, and accessories are cable managed and secured. Excessive load or weight must be distributed evenly. Failure to follow these guidelines may cause intermittent functionality.

Note

If the leg assemblies are at uneven heights, it is usually caused by an improperly installed hex rod. Disassemble one of the leg assemblies from the worksurface and make sure both ends of the hex rod are properly engaged in the hex drives near the top of the leg assemblies.

Standard Switch Save for Reference

Start Up Procedure:



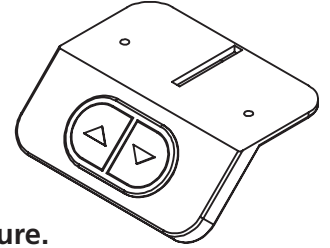









- Plug the power cord into a standard 110V receptacle. A power surge protector is recommended.
- Press the down arrow until the worksurface reaches its lowest position.
- The workstation is ready for use.
- **If the table is not functioning normally or has lost power, perform the reset procedure.**













Reset Procedure:

- Unplug the unit from the wall for 10 seconds.
- Clear all obstructions from the travel path of the desk.
- Plug the unit back in the wall.
- Press and hold the down arrow key until the table reaches its lowest position.

Add Container Stops:

- Move the table  to the upper or lower desired height.
- Rapidly press  4 times. You will hear a musical tone. 
- Rapidly press  2 times. A musical tone plays two times.  
 - To **add** the **upper** container stop press  A musical tone plays two times.  
 - To **add** the **lower** container stop press  A musical tone plays two times.  

Remove Container Stops:

- Move the table  to the upper or lower **preset** height.
- Rapidly press  4 times. You will hear a musical tone. 
- Rapidly press  2 times. A musical tone plays two times.  
 - To **delete** the **upper** container stop press  You will hear a musical tone. 
 - To **delete** the **lower** container stop press  You will hear a musical tone. 

Troubleshooting:

If you are having any problems with the operation, contact RightAngle Products at **800.298.4351** or **orders@raproducts.com**

Optional Programmable Switch (full instructions packaged with switch)

Start Up Procedure:

- Plug the power cord into a standard 110V receptacle. A power surge protector is recommended.
- Press the down arrow until the worksurface reaches its lowest position.
- The workstation is ready for use.
- **If the table is not functioning normally, or has lost power, perform the reset procedure.**

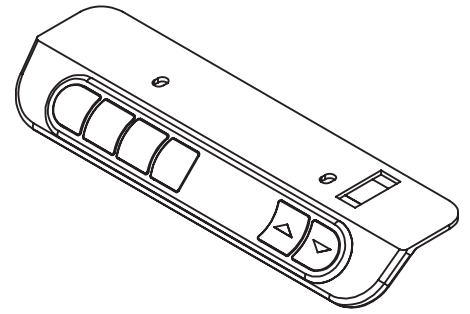

Reset Procedure:

- Unplug the unit from the wall for 10 seconds.
- Clear all obstructions from the travel path of the desk.
- Plug the unit back in the wall.
- Press and hold the down arrow key until the table reaches its lowest position

See Packaged Instructions for Programmable Options

Mechanical Reset Mode

If the table is unresponsive, uneven, or not functioning properly, perform a manual reset.











User settings are not reset in this process.

There are three methods to reset a workstation:

Reset Method A















1. Clear all obstructions from the travel path of the workstation
2. Disconnect the power to the control box for 30 seconds.
3. Reconnect the power
4. Press and hold the  until the workstation has reached its lowest possible position.

Reset Method B (4 button programmable switch required)

1. Clear all obstructions from the travel path of the workstation
2. Quickly press  +  +  +  to enter the menu mode.
3.  is displayed and you will hear a musical tone. 
4. Press the   to navigate the menu.
5. Navigate to the  display
6. Press the  button to enter or accept
7. Press and hold the  until the workstation has reached its lowest possible position.

The workstation is now ready to operate

Reset Method C - 2 Button Switch

1. Clear all obstructions from the travel path of the workstation
2. Quickly press  +  +  +  to enter the menu mode.
3. You will hear a musical tone. 
4. Press  +  +  + 
5. You will reach the limit adjustment menu and hear four musical tones.    
6. Press and hold the  until the workstation has reached its lowest possible position.

The reference is re-calibrated, the table should be leveled and the height indication should be correct.