

SAFETY & INSTRUCTION MANUAL  
**PD380**



Semi-Automatic  
Compact Pistol  
Cal. .380 ACP



READ THE INSTRUCTIONS AND WARNINGS IN THIS MANUAL CAREFULLY BEFORE USING THIS FIREARM.

**WALTHER ARMS, INC.**

**⚠ WARNING:** READ THESE INSTRUCTIONS AND WARNINGS CAREFULLY. BE SURE YOU UNDERSTAND THESE INSTRUCTIONS AND WARNINGS BEFORE USING THIS FIREARM. FAILURE TO READ THESE INSTRUCTIONS AND TO FOLLOW THESE WARNINGS MAY RESULT IN SERIOUS INJURY OR DEATH TO YOU AND OTHERS.

**This SAFETY & INSTRUCTION MANUAL should always accompany this firearm and be transferred with it upon change of ownership or when presented to another person.**

A copy of the SAFETY & INSTRUCTION MANUAL is available FREE upon request from:

WALTHER ARMS, Inc.  
Attn: Service Dept  
7700 Chad Colley Boulevard  
Fort Smith, AR 72916

Phone: 1-479-242-8500 ext. 507

E-mail: [customerservice@waltherarms.com](mailto:customerservice@waltherarms.com)  
[www.WaltherArms.com](http://www.WaltherArms.com)

**Note:** This manual refers to the use of the pistol by civilian users. Instructions for law enforcement use may differ from what is described in this manual. Throughout this instruction manual, position designations such as “left”, “right”, “forward”, “rear”, and so on, are referenced to a pistol held in a normal firing position. In other words, pointed away from the shooter, barrel in a generally horizontal direction, and with the grip of the pistol pointing downwards. Explanations in this manual are based on right hand operation. Left-handed users should operate vice versa. Note that the illustrations in this manual are for explanation purposes and may differ from the actual gun.

**DISCLAIMER OF LIABILITY:** The first concern when handling any firearm is safety. The failure to do so may result in property damage, could result in serious bodily injury or even death. WALTHER® specifically disclaims any and all liability from anyone arising out of the use of this firearm and its accessory. Under no circumstances shall WALTHER® be responsible for incidental or consequential damages with respect to economic loss or injury to person or property due to negligence, improper use, failure to follow instructions in this manual, unsafe handling, failure to maintain the pistol, unauthorized replacement of parts, disregard of statutory rules or laws or any other modification to the pistol.

## CONTENTS

<b>1. YOUR SAFETY RESPONSIBILITIES</b>	4
1.1 Safety is your number one responsibility!	4
1.2 Safe storage and transportation	9
<b>2. AMMUNITION</b>	12
<b>3. OPERATING INSTRUCTIONS</b>	13
3.1 Functional Elements	13
3.2 Manual safety	14
3.3 Loaded chamber indicator	14
3.4 Drop safety	15
<b>4. INSPECTION</b>	15
4.1 Inspection before use	15
4.2 Functional inspection	15
4.3 Inspection after use	16
<b>5. LOADING THE PISTOL</b>	16
5.1 Loading the chamber with the first cartridge	17
<b>6. FIRING</b>	18
6.1 Firing	18
6.2 Reloading the Pistol	19
<b>7. UNLOADING THE PISTOL</b>	20
<b>8. CLEARING MISFIRES</b>	21
<b>9. FIELD STRIPPING</b>	22
9.1 Disassembling	23
9.2 Cleaning	24
9.3 Lubrication	24
9.4 Maintenance before Storing	25
<b>10. ADJUSTING THE PISTOL TO ITS USER</b>	26
10.1 Sights	26
10.2 Front Sight	26
10.3 Rear Sight	26
10.4 Storage	27
<b>11. REPAIR OF WALTHER® PISTOLS</b>	27
<b>12. WARRANTY</b>	27
<b>13. CONTACT &amp; SHIPPING</b>	29
13.1 For Owners within the United States	29

## 1. YOUR SAFETY RESPONSIBILITIES

### 1.1 Safety is your number one responsibility!

At home, in the field, at the range, or anywhere, the first concern of every firearm owner should be safety. Apply the following safety rules in every situation, with any kind of firearm. If you feel uncertain about any operational aspects of your handgun, please contact.

WALTHER ARMS, Inc. at 1-479-242-8500 ext. 507 before proceeding with its operation.

**⚠ WARNING:** YOU MUST FOLLOW ALL OF THESE SAFETY RULES TO ENSURE THE SAFE USE OF YOUR FIREARM. THE FAILURE TO FOLLOW THESE BASIC FIREARM SAFETY RULES MAY RESULT IN AN UNINTENDED DISCHARGE WHICH COULD CAUSE SERIOUS PERSONAL INJURY OR DEATH TO YOU OR OTHERS AND DAMAGE TO PROPERTY.

- **ALWAYS KEEP YOUR FIREARM POINTED IN A SAFE DIRECTION.**

Never point a firearm at anyone or anything you do not intend to shoot, whether or not it is loaded. This is particularly important when loading, unloading, or field stripping the gun. ALWAYS control the direction of the firearm.

- **ALWAYS TREAT EVERY FIREARM AS IF IT IS LOADED AND WILL FIRE IF THE TRIGGER IS PULLED.**

Do not take anyone's word that the firearm is unloaded – always check for yourself. Never pass your firearm to another person until the action is open and you visually check that it is unloaded. Keep your firearm unloaded and safely stored when not in use.

- **NEVER PLACE YOUR FINGER INSIDE THE TRIGGER GUARD OR ON THE TRIGGER UNLESS YOU INTEND TO FIRE.**

Ensure that other objects do not touch the trigger.



## YOUR SAFETY RESPONSIBILITIES

- **ALWAYS BE SURE OF YOUR TARGET AND WHAT IS BEYOND IT.**

Always be sure of where the bullet will strike and shoot only where there is a safe backstop free of obstructions, water or other surfaces which can cause ricochets. Be sure your bullet will stop behind your target. Bullets can glance off many surfaces like rocks or surface water and travel in unpredictable directions with considerable velocity. Do not fire randomly into the sky.

- **NEVER CROSS OBSTACLES SUCH AS FENCES OR STREAMS WITH A LOADED FIREARM.**

- **SAFE GUN HANDLING IS YOUR PERSONAL RESPONSIBILITY AT ALL TIMES.**

Firearms are dangerous and can cause serious injury or death if they are misused or used inappropriately. Safety must be the prime consideration of anyone who owns or handles firearms. Accidents are the result of violating the rules of safe gun handling and common sense. Firearm safety training is available. Contact your dealer, law enforcement agency, local sportsman's club, etc. for more information.

- **YOU ARE RESPONSIBLE FOR THE FIREARM AT ALL TIMES.**

In owning a firearm, you must undertake full-time responsibility for your firearm's safety and security. You must protect yourself and all others against injury or death from misuse of the firearm 24 hours a day.

- **FIREARM SECURITY IS YOUR RESPONSIBILITY.**

You must secure firearms safely from children and/or unauthorized users. Your firearm should always be kept unloaded and locked when not in use. A lock has been provided for this purpose. Never assume that the use of this lock is sufficient to safely secure your firearm. You must always evaluate your personal situation and employ the security system(s) that meets your needs and prevents children and unauthorized users from gaining access to your firearm.

### APPROPRIATE USE FOR YOUR FIREARM MEANS USING YOUR FIREARM FOR LEGAL PURPOSES.

For example - target shooting and lawful resistance of deadly criminal force. It is your responsibility to ensure that you are in compliance with all applicable laws and ordinances regarding the use of your firearm.

- **NEVER RELY ON MECHANICAL FEATURES ALONE.**

Only your safe gun-handling habits will ensure the safe use of your firearm. This is your responsibility

- **ALWAYS SAFELY STORE AND SECURE YOUR FIREARM.**

Safe and secure storage of your firearm is one of your most important responsibilities. It is a full-time responsibility. You must always secure your firearm and ammunition separately so that they are not accessible to children and/or other unauthorized persons.

- **NEVER KEEP AMMUNITION IN THE SAME LOCATION AS THE HANDGUN.**

Store each in a separate and secure place.

- **ALWAYS WEAR EYE AND EAR PROTECTION THAT ARE SPECIFIED FOR FIREARM USE EVERY TIME YOU DISCHARGE YOUR FIREARM.**

Make sure others in the vicinity of where you will be shooting do so as well.

- **NEVER USE ALCOHOL OR DRUGS BEFORE OR WHILE SHOOTING.**

Do not use your firearm if you are on any medication which impairs, even slightly, your mental or physical ability.



## YOUR SAFETY RESPONSIBILITIES

- **ALWAYS HAVE ADEQUATE VENTILATION.**

Discharging firearms in poorly ventilated areas, cleaning firearms, or handling ammunition may result in exposure to lead and other substances known to cause birth defects, reproductive harm, and other serious physical injury. Review the warnings and labels for all ammunition and cleaning products carefully. Wash hands thoroughly after exposure.

- **BEFORE HANDLING ANY FIREARM, UNDERSTAND ITS OPERATION.**

Not all firearms are the same. Familiarize yourself with the mechanical features of any firearm you intend to use. If you feel uncertain about any operational aspects of your handgun, please contact WALTHER ARMS, Inc. at 1-479-242-8500 ext. 507 before proceeding with its operation.

- **NEVER ALLOW A FIREARM TO BE USED BY INDIVIDUALS WHO DO NOT UNDERSTAND ITS SAFE OPERATION OR HAVE NOT READ THESE FIREARM SAFETY RULES.**

- **ALWAYS USE THE CORRECT AMMUNITION FOR YOUR PARTICULAR FIREARM**

as indicated by the marking on the barrel. Never use non-standard, reloaded, or “handloaded” ammunition which has not been subjected to internal ballistic pressure testing.

- **BEWARE OF BARREL OBSTRUCTIONS.**

Be sure the barrel is clear of obstructions before shooting. Mud, water, snow or other objects may inadvertently lodge in the barrel bore. A small obstruction can cause a dangerous increase in pressure and may damage your firearm and cause injury to yourself and others.

- **BE SURE ALL ACCESSORIES, SUCH AS HOLSTERS AND GRIPS, ARE COMPATIBLE** with the handgun and that the accessories do not interfere with safe operation.
- **NEVER DISASSEMBLE YOUR HANDGUN** beyond the field stripping procedure outlined in this manual. Improper disassembly or reassembly of your handgun may be dangerous and can lead to serious injury or death.
- **NEVER MANIPULATE, ADJUST OR CHANGE ANY OF THE INTERNAL COMPONENTS OF YOUR FIREARM** including the firing, sear, or drawbar. Improper manipulation of any internal component may affect the safety and reliability of your firearm and may cause serious injury or death.
- **NEVER ALLOW ANY ALTERATION OR REPLACEMENT OF PARTS IN YOUR WALTHER® FIREARM UNLESS PERFORMED BY A QUALIFIED GUNSMITH** using genuine WALTHER® parts. If you do otherwise, improper functioning of your firearm may occur and serious injury or death and damage to property may result.



### **WARNING:**

SAFE USE OF A FIREARM IS YOUR PERSONAL RESPONSIBILITY AND THE FAILURE TO FOLLOW ALL OF THESE BASIC SAFETY RULES MAY RESULT IN SEVERE PERSONAL INJURY OR DEATH TO YOU OR OTHERS. YOU ARE THE MOST IMPORTANT SAFETY DEVICE WHEN IT COMES TO THE USE OF YOUR FIREARM AND WALTHER® WILL NOT BE RESPONSIBLE FOR ANY PERSONAL INJURY, DEATH OR PROPERTY DAMAGE THAT RESULTS FROM:

- (1) THE CRIMINAL OR NEGLIGENT USE OF THIS HANDGUN;
- (2) A DISREGARD OF THESE SAFETY INSTRUCTIONS AND WARNINGS;
- (3) IMPROPER OR CARELESS HANDLING OF THIS FIREARM;
- (4) THE USE OF NON-STANDARD, DEFECTIVE, IMPROPER OR RELOADED AMMUNITION; OR
- (5) IMPROPER OR NEGLIGENT MODIFICATIONS OR REPAIRS TO THE HANDGUN.



## YOUR SAFETY RESPONSIBILITIES

### 1.2 Safe storage and transportation

**⚠ WARNING:** FIREARMS ARE DANGEROUS WHEN USED AND STORED IMPROPERLY – THEY POSE A RISK OF SERIOUS OR FATAL INJURIES. FIREARMS CAN BE ESPECIALLY DANGEROUS TO CHILDREN WHEN THEY ARE STORED IN AN IRRESPONSIBLE AND UNSAFE MANNER.  
FOR YOUR SAFETY AND THE SAFETY OF OTHERS, IT IS IMPERATIVE THAT YOU KEEP YOUR FIREARM LOCKED AND UNLOADED IN A SECURE PLACE.  
THE AMMUNITION SHOULD BE STORED IN A SEPARATE, SECURE LOCATION WHEN IT IS NOT IN USE. SAFE AND SECURE STORAGE OF YOUR FIREARM IS ONE OF THE MOST IMPORTANT RULES OF FIREARM SAFETY. YOUR FAILURE TO FOLLOW THESE RULES MAY RESULT IN SERIOUS INJURY OR DEATH TO YOU OR OTHERS.

- **ALWAYS SECURE YOUR FIREARM IN A MANNER THAT WILL PREVENT UNAUTHORIZED ACCESS.**

When ever your firearm is not in use, keep it unloaded and locked. Your safety and the safety of others requires that you always secure and store your firearm in a manner that will prevent unauthorized access. Never leave a firearm unattended unless it is locked, unloaded and secured.

- **ALWAYS USE THE LOCK PROVIDED BY WALTHER® TO SECURE YOUR FIREARM.**

Please read and follow the instructions packaged separately for the use of this lock. A lock, when properly used, can be an effective tool in preventing unauthorized access to your firearm. There are other alternative locks and safe storage containers available in the marketplace which may also be appropriate for your particular needs.

Consult your local gun shop, hardware store, or local police department for guidance on the variety of other safe storage devices or practices which may be appropriate for your particular needs. By purchasing this firearm you have accepted the responsibility of safely securing the firearm at all times and preventing its unauthorized use. Never assume that the use of this lock alone is sufficient to safely secure your firearm. It is your personal responsibility to select and use whatever measures or practices that will enable you to be absolutely certain that your firearm is secure at all times.

**WARNING:**

NEVER LOCK A LOADED FIREARM AND NEVER LOAD A LOCKED FIREARM.

- **ALWAYS STORE YOUR FIREARM AND AMMUNITION SEPARATELY** so that they are not accessible to children or other unauthorized persons. Safe and secure storage of your firearm and ammunition are your responsibility. It is a full-time responsibility.
- **NEVER ASSUME THAT A “HIDING” PLACE IS A SECURE STORAGE METHOD.**  
Others may be aware of your storage location or come upon it by chance. It is your personal responsibility to use common sense when storing your firearm and ammunition and to always make sure they are not accessible to children or other unauthorized persons.
- **NEVER TRANSPORT A LOADED FIREARM.**

When transporting your firearm, be sure it is unloaded and locked. Safe and secure transportation of your firearm is your responsibility.



## YOUR SAFETY RESPONSIBILITIES

- **ALWAYS FOLLOW THE LAW!**

Many jurisdictions have laws that make it a crime to keep a firearm unlocked and in an area accessible to children or others. Keeping a firearm locked and unloaded when not in use is not only a common sense safety practice ... IT IS THE LAW. You must be familiar with all local, state, and federal laws regarding the safe storage and transportation of your firearm. Failure to know and follow the law may result in unauthorized access or use of your firearm by another. Obey all laws relating to the storage and transportation of firearms. Your local police department or gun shop can furnish you with available information on storing and/or transporting a firearm safely and legally.

- **YOUR FIREARM IS YOUR RESPONSIBILITY.**

You must prevent your firearm from being stolen or from being used by untrained or unqualified individuals. Keep it locked, unloaded and secured when not in use.

fig. 1



- Use only commercially manufactured ammunition with internal ballistic pressure which are in strict accordance with the specifications of the Sporting Arms and Ammunition Manufacturers Institute (SAAMI). If you are uncertain, contact your ammunition supplier for verification.

**⚠ WARNING:** NEVER USE AMMUNITION NOT SPECIFICALLY DESIGNATED FOR USE IN YOUR FIREARM. FAILURE TO USE THE SPECIFIC CARTRIDGE INTENDED FOR USE IN THE PD380 PISTOL MAY CAUSE THE PISTOL TO JAM, FAIL TO FIRE OR EVEN GENERATE EXCESSIVE GAS PRESSURE WHICH CAN DAMAGE OR DESTROY THE PISTOL, CAUSE PERSONAL INJURY, DEATH OR PROPERTY DAMAGE.

## 2. AMMUNITION

- Use only ammunition specifically recommended by WALTHER® for your firearm.
- Never mix ammunition.
- Never use a cartridge not specifically designated for use in your firearm. Pressure from the wrong type of ammunition may exceed the capability of your firearm and may damage or even rupture your firearm.
- In some cases, a round of ammunition not specified for your handgun may fit into the chamber. Firing ammunition not specified on your handgun may cause it to rupture and cause serious injury or death to you or others.
- Always inspect your ammunition before using it. Never use dirty, corroded or damaged ammunition which can lead to a burst cartridge which may cause damage to the handgun and personal injury or death.
- “Plus-P” (+P) ammunition generates pressures in excess of the pressure associated with standard ammunition. Such pressures may affect the wear characteristics or exceed the margin of safety. Use of (+P) ammunition may require more frequent service.
- “Plus-P-Plus” (+P+) ammunition is not recommended for use in WALTHER® firearms. This marking on the ammunition designates that it exceeds established industry standards, but the designation does not represent defined pressure limits and therefore such ammunition may vary significantly as to the pressures generated and could be DANGEROUS.

## 3. OPERATING INSTRUCTIONS

### 3.1 Functional Elements



fig. 2



fig. 3

Adjustable rear sight

Manual safety

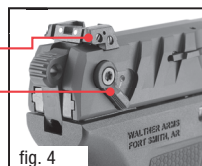

**⚠ WARNING:** ALWAYS LEAVE THE MANUAL SAFETY ENGAGED UNTIL YOU INTEND TO FIRE.

### 3.2 Manual safety

- SAFE POSITION – rotate the safety lever to lower position (fig. 5).  
 FIRE POSITION – rotate the safety lever to upper position (fig. 6).



### 3.3 Loaded chamber indicator

The WALTHER® PD380 has a loaded chamber indicator. This indicator can be observed by looking at the upper rear end of the ejection port (fig. 7, 8). By looking into this opening, you can observe whether or not a round is in the firearm's chamber. If a round is in the chamber, you would see the actual brass or silver colored rim through this opening.



**⚠ WARNING:** NEVER RELY UPON THE LOADED CHAMBER INDICATOR ALONE TO VERIFY THE PRESENCE OR ABSENCE OF A ROUND IN THE CHAMBER. THE SUREST METHOD TO DETERMINE THE PRESENCE OR ABSENCE OF A ROUND IN THE CHAMBER IS TO VISUALLY CHECK THE CHAMBER OF YOUR FIREARM BY REMOVING THE MAGAZINE AND PULLING AND LOCKING THE SLIDE IN THE OPEN POSITION.

## INSPECTION

**⚠ WARNING:** ALWAYS TREAT EVERY FIREARM AS IF IT WERE LOADED AND WOULD FIRE IF THE TRIGGER IS PULLED. A LOADED CHAMBER INDICATOR MAY HELP DETERMINE WHETHER THE CHAMBER IS LOADED OR UNLOADED. THE AMOUNT OF LIGHT CLEANLINESS OF THE PISTOL, DISCOLORATION OF THE AMMUNITION AND OTHER FACTORS MAY LIMIT THE EFFECTIVENESS OF THE LOADED CHAMBER INDICATOR.

**⚠ WARNING:** ALWAYS INSPECT THE CHAMBER OF YOUR PISTOL AFTER THE MAGAZINE HAS BEEN REMOVED FROM THE GUN. MAKE SURE THAT NO CARTRIDGE IS LEFT IN THE CHAMBER.

### 3.4 Drop safety

The drop safety (firing pin safety) is only disengaged when the trigger is pulled. If the weapon is dropped or falls, then the firing pin safety prevents movement of the Hammer.

**⚠ WARNING:** ALL SAFETY DEVICES OF THE FIREARM ARE MECHANICAL SAFETIES, AND THE SHOOTER IS THE ONLY ONE WHO SHOULD ENGAGE AND DISENGAGE THESE SAFETIES. NEVER RELY SOLELY ON MECHANICAL SAFETIES - ALWAYS BE EXTREMELY CAREFUL AND AVOID SITUATIONS WHICH COULD LEAD TO AN ACCIDENT.

## 4. INSPECTION

### 4.1 Inspection before use

**⚠ WARNING:** MAKE SURE THAT THE PISTOL IS UNLOADED (CHAMBER CLEARED, BARREL CLEAR OF ANY OBSTRUCTIONS, MAGAZINE EMPTY) FOR INSPECTION AND THAT THE SAFETY IS ENGAGED. IN THE UPPER POSITION.

**⚠ WARNING:** GRIP FROM **ABOVE** OR FROM THE **BACK** WHEN PULLING THE SLIDE (FIG. 5). NEVER PUT YOUR HAND IN FRONT OF THE MUZZLE (FIG. 6).

### 4.2 Functional inspection

1. Check to make sure the chamber and magazine are empty. Remove the magazine, retract the slide. After the slide has been released, the recoil spring will return the slide fully forward into battery.

2. Insert the empty magazine, retract the slide. The slide should be locked back in its rearmost position by the slide stop.
3. Remove the magazine, pull the slide back slightly and release the slide. After the slide has been released, the recoil spring should return the slide fully forward into battery.



### 4.3 Inspection after use

**⚠ WARNING:** MAKE SURE THAT THE PISTOL IS UNLOADED (CHAMBER AND BARREL MUST BE CLEAR) AFTER USE, THAT THE MAGAZINE IS EMPTY, AND THAT THE SAFETY IS ENGAGED, (IN THE LOWER POSITION) POINT MUZZLE IN A SAFE DIRECTION. PULL THE TRIGGER TO DECOCK THE HAMMER. ROTATE THE SAFETY UP TO THE SAFE POSITION.

## 5. LOADING THE PISTOL

**⚠ WARNING:** MAKE SURE THAT THE PISTOL IS UNLOADED (CHAMBER CLEARED, BARREL CLEAR OF ANY OBSTRUCTIONS, MAGAZINE EMPTY) FOR INSPECTION AND THAT THE SAFETY IS IN THE SAFE POSITION AND THE PISTOL IS POINTED IN A SAFE DIRECTION.

**⚠ CAUTION:** UNJACKETED LEAD PROJECTILES CAUSE INCREASED FOULING, WHICH CAN RESULT IN MALFUNCTIONS.



## LOADING THE PISTOL

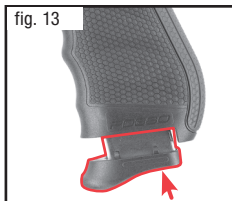
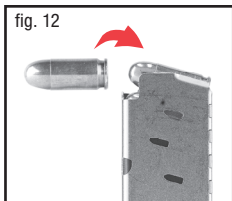

- Engage the safety, in upper position. Press the magazine release and remove the empty magazine (fig.11). Holding the empty magazine in your hand, push the cartridge under the magazine lips, at the same time pushing down the follower (fig.12). Do not use excessive force. Damaged magazine lips will cause malfunctions and will render the magazine useless.
- Push the loaded magazine into the magazine well until the magazine catch locks it. (fig.13)

**CAUTION:** AFTER INSERTING A MAGAZINE, ALWAYS TEST TO MAKE SURE IT IS LOCKED IN PLACE BY APPLYING SOME REMOVAL PRESSURE TO THE EXPOSED PORTION OF THE BUTT PLATE.

### 5.1 Loading the chamber with the first cartridge



Pick up the pistol with your shooting hand and point the muzzle in a safe direction. Use your other hand to retract and release the slide (fig. 14). Never put your hand in front of the muzzle. As the slide travels forward it inserts the first round into the chamber. The Hammer is now cocked. You are now in the single action firing mode. Leave the safety in the safe position until you are ready to fire.

**⚠ WARNING:** ALWAYS LOAD A ROUND INTO THE CHAMBER BY FEEDING IT FROM THE MAGAZINE. NEVER ATTEMPT TO LOAD THE PISTOL BY INSERTING A ROUND INTO THE CHAMBER VIA THE OPEN EJECTION PORT. FAILURE TO FOLLOW THIS WARNING MAY RESULT IN A SEVERE INJURY OR DEATH TO YOU OR OTHERS.

**⚠ WARNING:** THE PISTOL IS NOW LOADED AND READY TO FIRE. THE PISTOL AND ITS MAGAZINE ARE NOW LOADED AND WILL FIRE WHEN THE TRIGGER IS SQUEEZED. REMEMBER TO KEEP THE MUZZLE POINTED IN A SAFE DIRECTION UNDER ALL CONDITIONS AND ALWAYS KEEP YOUR FINGER OR ANY OTHER OBJECT OFF THE TRIGGER AND OUTSIDE THE TRIGGER GUARD UNTIL YOU DECIDE TO FIRE THE PISTOL. NEVER LEAVE A LOADED FIREARM UNATTENDED OR OUT OF YOUR DIRECT CONTROL.

**⚠ WARNING:** YOUR PISTOL IS NOW READY TO FIRE. KEEP YOUR FINGER OFF THE TRIGGER AND OUT OF THE TRIGGER GUARD UNTIL YOU ARE READY TO FIRE.

## 6. FIRING

**⚠ WARNING:** YOUR GUN IS NOW READY TO FIRE. PER SAFETY INSTRUCTIONS, KEEP YOUR TRIGGER FINGER AWAY FROM TRIGGER UNTIL YOU INTEND TO FIRE.

### 6.1 Firing

- You may fire this Pistol in two different ways: double action or single action. To fire "double action" the gun is loaded but the hammer is not cocked. To fire "single action" means that the hammer is cocked before firing.
- With a firm grip, keep muzzle pointed in a safe direction and your finger outside the trigger guard, place the manual safety in the fire position, allow your finger to be placed squarely across the face of the trigger. Squeeze the trigger fully to the rear. As the trigger is drawn fully to the rear, the Hammer is released, striking the cartridge primer. Upon firing, the slide moves rearward thereby extracting and ejecting the spent cartridge case. The slide then returns forward feeding the next cartridge from the magazine into the chamber. Now the Hammer is cocked again.

## FIRING

- After firing, you must allow the trigger to move fully forward before you can fire the next shot. Keep your finger off the trigger and outside the trigger guard until you are ready to fire again. This sequence can be repeated until the last round has been fired.
- Once the last round has been fired, the magazine follower exerts upward pressure on the slide stop causing it to engage the slide and to hold it in the “open” position.

### 6.2 Reloading the Pistol

After the last round has been fired, the internal slide stop holds the slide in the open position. Place the manual safety in the safe position. To continue shooting - Replace the empty magazine with a full one. Pull slide rearward and release, the slide will travel forward and load the chamber with the first round. Keep your pistol in your shooting hand, finger off the trigger and pointed in a safe direction.

**⚠ WARNING:** THE PISTOL IS READY TO FIRE. WITH THE MUZZLE STILL POINTING IN A SAFE DIRECTION, KEEP YOUR FINGER OFF THE TRIGGER AND OUTSIDE THE TRIGGER GUARD UNTIL YOU ARE READY TO FIRE.

**⚠ WARNING:** WEAR EYE AND EAR PROTECTION SPECIFIED FOR FIREARM USE EVERY TIME YOU DISCHARGE YOUR FIREARM. MAKE SURE OTHERS IN THE VICINITY OF WHERE YOU WILL BE SHOOTING DO SO AS WELL.

**⚠ CAUTION:** AFTER INSERTING A MAGAZINE, ALWAYS TEST TO MAKE SURE IT IS LOCKED IN PLACE BY APPLYING SOME REMOVAL PRESSURE TO THE EXPOSED PORTION OF THE BUTT PLATE.

**⚠ WARNING:** UPON FIRING THE PISTOL OR RELEASING THE SLIDE FROM THE SLIDE STOP, THE SLIDE MOVES REARWARD OR FORWARD WITH SIGNIFICANT FORCE AND SPEED. TO AVOID INJURY, BE SURE NO PART OF YOUR HAND IS IN THE PATH OF THE SLIDE'S TRAVEL.

**⚠ WARNING:** THE WALTHER® PD380 WILL FIRE WITH THE MAGAZINE REMOVED FROM THE PISTOL.

## 7. UNLOADING THE PISTOL

**WARNING:**

KEEP THE PISTOL POINTING IN A SAFE DIRECTION WHEN UNLOADING. FAILURE TO DO THIS CAN RESULT IN SERIOUS INJURY OR DEATH.

**WARNING:**

ANY TIME YOU RELEASE THE SLIDE WHILE A MAGAZINE CONTAINING CARTRIDGES IS IN THE PISTOL, YOU WILL HAVE CHAMBERED A NEW ROUND IN THE PISTOL. THE PISTOL WILL BE READY TO FIRE.

- Point the muzzle in a safe direction. Make sure your finger is off the trigger and out of the trigger guard. Press the magazine release and remove the magazine (fig. 15).
- Keep the muzzle pointed in a safe direction, and keep your finger off the trigger and outside the trigger guard. Grasp the serrated sides of the slide from the rear with the thumb and fingers, and briskly draw the slide fully rearward in order to extract any cartridge from the chamber and clear it from the pistol. Do not obstruct the ejection port because doing so can interfere with proper ejection of a cartridge (fig. 16).
- Visually check the barrel chamber to be sure it is empty. Look into the chamber and down through the magazine well. Verify that no ammunition remains in the pistol. Check the barrel bore visually for any obstructions (fig. 17).
- Unload the magazine by holding it with the bullet end of the cartridge pointing away from you and pushing each cartridge forward and out of the magazine (fig. 18 ).
- Insert the empty magazine, retract the slide. The slide should be locked back in its rearmost position by the slide stop and remove the the empty magazine.

## CLEARING MISFIRES

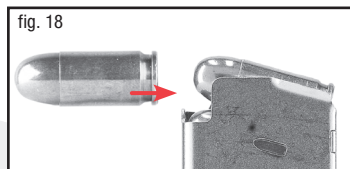
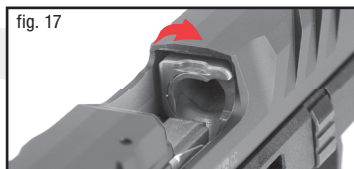

### 8. CLEARING MISFIRES

**⚠ WARNING:** IF YOUR FIREARM GIVES ANY INDICATION THAT IT IS NOT PERFORMING PROPERLY OR THE OPERATION OF YOUR FIREARM HAS CHANGED “THE WAY IT FEELS OR SOUNDS”, STOP FIRING. MAKE SURE THE FIREARM IS POINTED IN A SAFE DIRECTION, UNLOAD THE FIREARM AND HAVE IT INSPECTED AND TEST FIRED BY A GUNSMITH QUALIFIED TO PERFORM SERVICE ON WALTHER ARMS.

- If a cartridge fails to fire, wait 10 seconds while keeping the muzzle pointed in a safe direction.
- Keep your finger off the trigger and out of the trigger guard.
- Remove the magazine.
- Place manual safety in the safe position.
- Grasp the slide from the rear and briskly pull it fully rearward to eject the misfired round.
- In order to lock the slide in the open position, inserting an empty magazine and retract the slide. The slide should be locked back in its rearmost position by the slide stop and remove the empty magazine.
- You must be certain there are no cartridges in the chamber or obstructions in the barrel. Remember that any time you release the slide while a magazine containing cartridges is in the pistol, you will have reloaded the pistol and it will be capable of firing.

- If there are any obstructions in the barrel bore, have the pistol further examined and repaired by a qualified gunsmith before using again.

**⚠ WARNING:** NEVER TRY TO USE A MISFIRED CARTRIDGE AGAIN.

## 9. FIELD STRIPPING

### The main components of the pistol

fig. 19



**⚠ WARNING:** ALWAYS KEEP THE BARREL POINTED IN A SAFE DIRECTION.

**⚠ WARNING:** ALWAYS FOLLOW THE FIELD STRIPPING INSTRUCTIONS EXACTLY. NEVER DO ANYTHING BEYOND WHAT YOU ARE SPECIFICALLY INSTRUCTED TO DO IN THIS MANUAL. NEVER ALTER OR MODIFY THE PARTS IN YOUR PISTOL.

**⚠ WARNING:** WEAR SAFETY GLASSES EVERY TIME YOU ASSEMBLE OR DISASSEMBLE YOUR FIREARM.

**⚠ WARNING:** DO NOT ALTER, MODIFY OR REPLACE ANY OF THE PARTS OF YOUR FIREARM UNLESS THIS WORK IS PERFORMED BY A QUALIFIED GUNSMITH USING GENUINE WALTHER® PARTS. IF YOU DO OTHERWISE, IMPROPER FUNCTIONING MAY OCCUR AND SERIOUS INJURY, DEATH OR DAMAGE TO PROPERTY MAY RESULT.

## 9.1 Disassembling

- Make sure your firearm is unloaded before beginning to disassemble.
- Keep the muzzle pointed in a safe direction, place manual safety in the safe position and remove the magazine (fig. 20).
- Pull the takedown lever straight down (fig. 21).
- Move the slide forward, and remove it from the frame (fig. 22) while still holding the takedown lever.
- Remove the recoil guide rod assembly from below the barrel while taking up the spring pressure (fig. 23).
- The main components of the pistol are shown in (fig. 19).

fig. 20



fig. 21



fig. 22

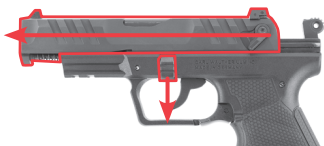
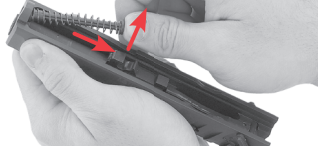

fig. 23



## 9.2 Cleaning

In order to keep the pistol functional and extend its service life, the WALTHER® PD380 should be cleaned and maintained at regular intervals. Especially after being exposed to extreme conditions.

**⚠ WARNING:** ENGAGE THE SAFETY, REMOVE THE MAGAZINE, OPEN THE SLIDE, AND INSPECT THE CHAMBER TO MAKE SURE IT IS EMPTY.

**⚠ WARNING:** ENSURE YOUR FIREARM IS UNLOADED BEFORE BEGINNING TO CLEAN IT. ALWAYS FOLLOW THE RULES OF SAFE GUN HANDLING.

Also, before using the pistol for the first time, it should be examined and cleaned. The pistol has been treated with either a preservative or oil to protect it against corrosion. Before using it, all excess oil should be wiped from the bore, chamber, and exposed areas using a clean swab or patch. Field-strip the pistol as previously described. Starting with the barrel and from chamber end, insert a brush through the bore of the barrel until the bristles completely exit at muzzle end. Pull the brush back until the bristles completely exit at chamber end. Use a good powder-removing solvent and brass bristle bore brush to remove lead and firing residue from the interior of the barrel. Wipe the areas clean with patches or a swab.

Using a small brush dipped in solvent, remove all deposits from around the breech face, chamber end of the barrel, extractor and adjacent areas which have been exposed to powder or primer residue. Remove any residue on the frame with light brushing and a solvent. After cleaning, apply a light film of high quality gun lubricant to all external metal surfaces and wipe clean.

If the pistol will be used or stored in a cold climate, be sure to use appropriate lubricant that will not congeal at low temperatures.

## 9.3 Lubrication

After cleaning the entire pistol, use a cloth to apply a light film of high quality gun lubricant to all external metal surfaces and wipe clean. Do not over-lubricate the pistol to the extent where lubricant will be dripping or running down the handgun. Excess lubricant can attract dirt, unburned powder and carbon residue, which can interfere with proper functioning of the pistol. Do not put any gun lubricant into the striker channel.

- **Barrel:**

Use a cloth to apply a light film of high quality gun lubricant to all external surfaces and the ramp where the locking block cams the barrel [A, B].



## FIELD STRIPPING

- **Frame:**  
Put only one drop of lubricant on the slide guides [C], and on the trigger bar [D].
- **Slide:**  
Put only one drop of lubricant on the safety plunger [E] and the disconnecter cut [F].
- **Magazine:**  
Apply a light film of high quality gun lubricant to all external metal surfaces.

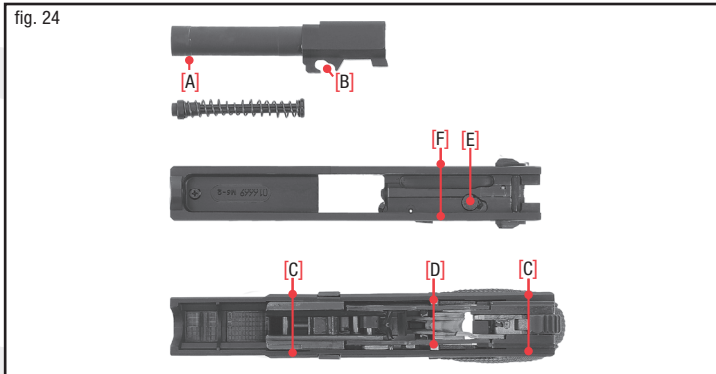

### 9.4 Maintenance before Storing

Obey all laws and regulations relating to the storage of firearms. You must familiarize yourself with all local, state, and federal laws regarding the safe storage of firearms and ammunition. When storing the pistol, do not encase the firearm in anything that will attract or hold moisture, such as leather or heavy cloth. If the firearm is to be stored for an extended period, the bore, chamber and internal working mechanism should be lubricated with a high quality lubricant or preservative intended for firearms. The external working mechanisms, slide, barrel, and magazine should be coated with anti-corrosion lubrication. Before using the pistol again, be sure to clean it. Every time you clean the firearm, check it for signs of wear. If wear is noted, do not use the firearm. Return it to WALTHER for service or have it checked by a qualified gunsmith.

## 10. ADJUSTING THE PISTOL TO ITS USER

**⚠ WARNING:** MAKE SURE THE HANDGUN IS ON SAFE AND UNLOADED BEFORE MAKING ANY ADJUSTMENTS.

### 10.1 Sights

The front and rear sight are replaceable. The point of impact is adjustable for windage and elevation.

### 10.2 Front Sight

Unscrew the front sight from the bottom of the front sight. Push the front sight out of the slide. Assembly is in reverse order. Screw in the front sight screw until it is flush.

**⚠ CAUTION:** USE A MINIMAL AMOUNT OF FORCE WHEN ADJUSTING THE REAR SIGHT.

### 10.3 Rear Sight

If shots group high, turn the rear adjustment screw (fig. 25 [1]) clockwise, if they group low, turn it counter clockwise. Adjustment by one click moves the impact point approximately 2 cm at a distance of 25 m. If shots group to the left, turn the forward adjustment screw (fig. 25 [2]) clockwise, if they group to the right, turn it counter clockwise. Adjustment by one click moves the impact point approximately 1 cm at a distance of 25 m.

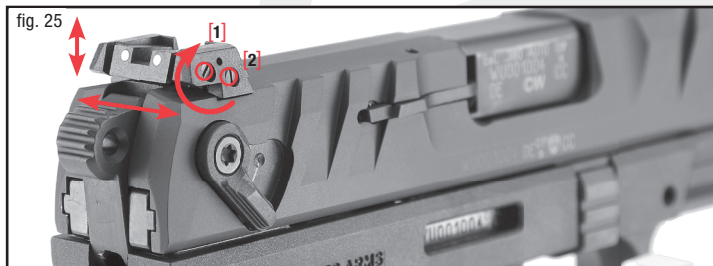



## REPAIR OF WALTHER® PISTOLS

### 10.4 Storage

**⚠ WARNING:** NEVER LEAVE A LOADED FIREARM UNATTENDED AND NEVER STORE YOUR FIREARM IN A LOADED POSITION.

Always store your pistol in an unloaded condition with the safety in the safe position. Keep the pistol and ammunition away from children and unauthorized persons. Firearms should be stored separately from ammunition.

## 11. REPAIR OF WALTHER® PISTOLS

**⚠ WARNING:** ANY MAINTENANCE OR SERVICE NOT SPECIFIED IN THIS MANUAL MUST BE PERFORMED BY A QUALIFIED GUNSMITH USING GENUINE WALTHER® PARTS. YOU MAY PURCHASE ACCESSORIES FOR YOUR WALTHER® FIREARM. YOU MUST HAVE SOME OF THESE PARTS INSTALLED BY A GUNSMITH QUALIFIED TO PERFORM SERVICE ON WALTHER ARMS PISTOLS. YOU MUST NEVER ATTEMPT TO MODIFY YOUR FIREARM OR INSTALL REPLACEMENT PARTS IN YOUR FIREARM. ALWAYS USE A QUALIFIED WALTHER ARMS GUNSMITH EVEN IF THE REPAIR SEEMS TO BE SIMPLE. IF YOU DO OTHERWISE, IMPROPER FUNCTIONING OF YOUR FIREARM MAY OCCUR AND SERIOUS INJURY, DEATH OR DAMAGE TO PROPERTY MAY RESULT.

**⚠ CAUTION:** A FIREARM WHICH FAILS TO FUNCTION PROPERLY IS DANGEROUS. IT SHOULD BE SAFELY STORED IN A WAY THAT PREVENTS ITS USE UNTIL IT IS REPAIRED.

## 12. WARRANTY

- The Walther Legendary Lifetime Limited Warranty gives you absolute confidence in your decision when you purchase a WALTHER. With WALTHER, you can rely on the precision of German engineering and the dependability of an American guarantee. Our warranty provides unwavering support for your new firearm and continues for the lifecycle of the product as long as the company manufactures and supports it. If you purchase a WALTHER firearm, it carries its Legendary Warranty regardless of whether or not you are the original purchaser. This Warranty covers WALTHER centerfire and rimfire firearms produced after 1993 only and does not apply to antique, limited edition or custom firearms.

- If your WALTHER firearm has a defect in materials or workmanship, please contact WALTHER or return the firearm, postage paid, with a brief description of the problem to us at the following address for a repair or replacement at no cost to you:

**WALTHER ARMS, Inc.  
7700 Chad Colley Blvd  
Fort Smith, AR 72916**

- This Warranty does not cover cosmetic blemishes or wear and tear associated with normal use.
- This Warranty does not cover any problems caused by abuse, misuse, or acts of God.
- This Warranty does not cover defects or damage caused by the use of parts or service not provided by WALTHER.
- WALTHER assumes no liability for consequential, punitive or other damages (except as set forth herein) related to a claim under this Warranty. A service and/or handling charge may be required for non-warranty repairs.
- This Warranty applies to the United States of America and covers only firearms currently produced and supported by WALTHER and distributed by WALTHER ARMS Inc. in Fort Smith Arkansas in the United States of America.
- This Warranty does not cover firearms that have been discontinued by Carl Walther or WALTHER ARMS Inc.
- This warranty gives you specific legal rights, and you may also have other rights which vary from state to state.
- Warranty Claims and Repair for U.S. customers. Call WALTHER ARMS (479)-242-8500 ext 507. If it is determined a return is necessary, you will be issued a Firearm Return Authorization Number. Write this number boldly on the box and return the product prepaid to WALTHER ARMS. Your name, address, phone number and a note with the model name/number, serial number, and explanation of the defect found must be included with the firearm. A copy of the original dated cash register receipt, or a copy of ATF Form 4473, indicating date of purchase must accompany the return. It is important that the owner comply with all applicable federal, state and local laws and regulations in the shipment of the WALTHER PD380 pistol to the applicable WALTHER Service Center. It is recommended that shipments be insured by the owner, since WALTHER will accept no responsibility for loss or damage in transit. Transportation and insurance charges for return to the owner will be paid by WALTHER if the claim is covered by this warranty.

**UNDER NO CIRCUMSTANCES SHALL WALTHER BE RESPONSIBLE FOR INCIDENTAL OR CONSEQUENTIAL DAMAGES WITH RESPECT TO ECONOMIC LOSS, INJURY, DEATH OR PROPERTY DAMAGE, WHETHER AS A RESULT OF BREACH OF THIS WARRANTY, NEGLIGENCE OR OTHERWISE.**



## CONTACT & SHIPPING

- Some States do not allow the exclusion or limitation of incidental or consequential damages, so the above limitation or exclusion may not apply to you.

### **WALTHER will not be responsible for:**

- Defects or malfunctions resulting from careless handling, unauthorized adjustments or modifications made or attempted by anyone other than a qualified gunsmith following WALTHER authorized procedures, or failure to follow the instructions in the WALTHER PD380 Safety & Instruction manual.
- Use of defective or improper ammunition, corrosion, neglect, abuse, ordinary wear and tear, or unreasonable use.
- Use of replacement parts, other than WALTHER factory or authorized parts.
- Criminal misuse, negligence, or use under the influence of drugs or alcohol.
- This warranty gives you specific legal rights and you may also have other rights, which vary from State to State.



### **WARNING:**

WHEN TRANSPORTING A FIREARM, MAKE SURE THAT IT IS UNLOADED AND THAT THE SAFETY IS IN THE SAFE POSITION.

## 13. CONTACT & SHIPPING

### 13.1 For Owners within the United States

WALTHER ARMS, Inc.  
Attn: Service Dept  
7700 Chad Colley Boulevard  
Fort Smith, AR 72916

Phone: 1-479-242-8500 ext. 507

E-mail: [customerservice@waltherarms.com](mailto:customerservice@waltherarms.com)  
[www.WaltherArms.com](http://www.WaltherArms.com)

- Call or e-mail the Customer Service Dept. for authorization and shipping instructions.
- ENSURE THAT THE FIREARM IS UNLOADED.
- DO NOT SHIP ANY AMMUNITION.
- Enclose a letter which includes your full name and address (no P.O. Boxes, please), daytime telephone number, e-mail address, the serial number of the firearm, and details of the problem experienced (stating the brand and type of ammunition used when the problem occurred) or work desired.
- Record the serial number before shipping and retain in a secure place.

- Please remove all custom parts and accessories, such as stocks, special sights, or holsters from your firearm before returning.
- Place the handgun in its original case or in a similarly secure container and pack securely.
- When returning a pistol, please include all magazines ensuring they are unloaded; they are important to the proper function of the handgun.
- The package must NOT bear any markings which indicate the identity of the contents.
- It is most important that you comply with federal, state, and local laws and regulations.
- The following guidelines are meant to help, but you must seek assistance from the appropriate authorities if necessary.
- Do not attempt to ship a handgun via US Postal Service; only federally licensed dealers may ship a firearm by US Postal Service.

**⚠ WARNING:** THIS HANDGUN IS NOT EQUIPPED WITH A DEVICE THAT FULLY BLOCKS USE BY UNAUTHORIZED USERS. MORE THAN 200,000 FIREARMS LIKE THIS ONE ARE STOLEN FROM THEIR OWNERS EVERY YEAR IN THE UNITED STATES. IN ADDITION, THERE ARE MORE THAN A THOUSAND SUICIDES EACH YEAR BY YOUNGER CHILDREN AND TEENAGERS WHO GET ACCESS TO FIREARMS. HUNDREDS MORE DIE FROM ACCIDENTAL DISCHARGE. IT IS LIKELY THAT MANY MORE CHILDREN SUSTAIN SERIOUS WOUNDS OR INFLICT SUCH WOUNDS ACCIDENTALLY ON OTHERS. IN ORDER TO LIMIT THE CHANCE OF SUCH MISUSE, IT IS IMPERATIVE THAT YOU KEEP THIS WEAPON LOCKED IN A SECURE PLACE AND TAKE OTHER STEPS NECESSARY TO LIMIT THE POSSIBILITY OF THEFT OR ACCIDENT. FAILURE TO TAKE REASONABLE PREVENTATIVE STEPS MAY RESULT IN INNOCENT LIVES BEING LOST, AND IN SOME CIRCUMSTANCES MAY RESULT IN YOUR LIABILITY FOR THESE DEATHS.

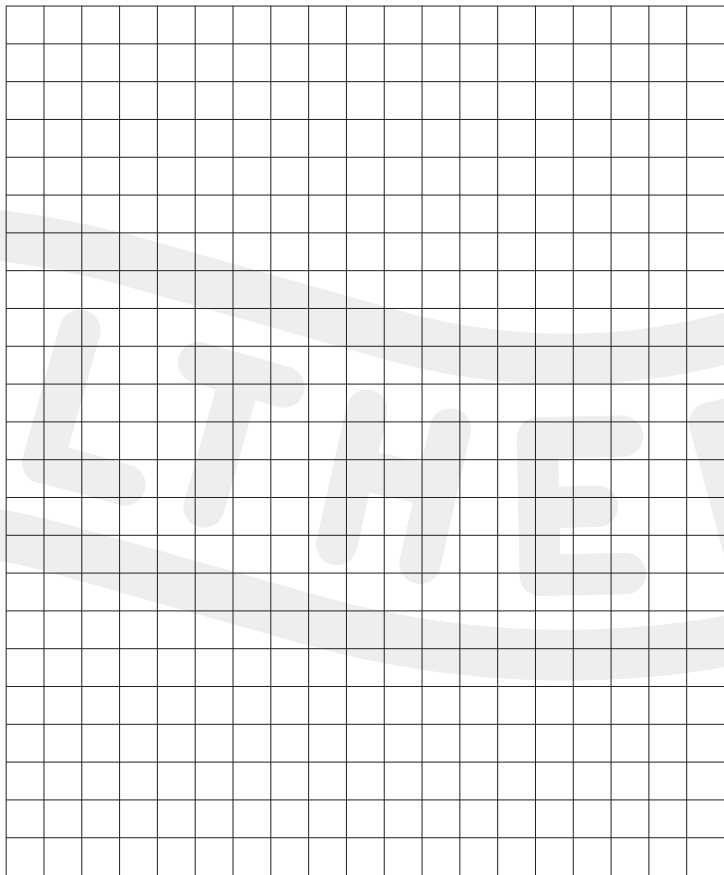



**WALTHER ARMS, INC.**

7700 CHAD COLLEY BOULEVARD  
FORT SMITH, AR 72916  
PHONE: 1-479-242-8500



Copyright © 2023 · Carl WALTHER GmbH · All rights reserved · Subject to change without notice.

8.505.82.02-06.2023 Rev.A

**WALTHERARMS.COM**